

WORLD
www.wslightings.com
Stage Lightings

WSLIGHTINGS®

DD - 620

6x20A DIGITAL DIMMER PACK

İTHALATÇI:
START ELEKTRONİK SAN.VE TİC. LTD. ŞTİ.
ADRES: ŞAFAK MAH. 854 SOK. NO:8/A-B
TEL:+90 312 485 60 00 GÖLBAŞI / ANKARA



User's Instructions

S.N :



WORLD
www.wslightings.com
Stage Lightings

All Rights Reserved!

Contents

Features 1

General Instructions 2

1. Overview 3

- 1.1 Front View 3
- 1.2 Rear View 5
- 1.3 Wiring Diagram 6

2. Menu System 7

2.1 Default Menu 7

- 2.1.1 Adjust channel intensity temporarily 7
- 2.1.2 Adjust whole intensity temporarily 7

2.2 Setting Menus 8

- 2.2.1 Patching 8
- 2.2.2 DMX fail 11
- 2.2.3 MaxLevel 12
- 2.2.4 MinLevel 13
- 2.2.5 Curve 15

3. Technical Specifications 17

3. Technical Specifications

Power Input	AC 230V~50-60Hz, 120A max.
Channel Output(Single phase).....	20A/CH., Total 120A
Channel Output(Three phases).....	20A/CH., Total 40A per phase
DMX Output	3 pin female XLR socket
DMX Input	3 pin male XLR socket
Analogue Input	0-10V, 8-pin din socket
Dimensions	482x390x90mm
Weight(appro.)	9.0kg

Improvement and changes to specifications, design and this manual, may be made at any time without prior notice.

All Rights Reserved!

2. Menu System

2.2.5 Curve

6. When channel is activated, tap UP/DOWN button to select from [1-6]; when chase mode is activated, tap UP/DOWN button to select from Linear/S-Curve/Non Dim/Square.

Chan[1]
Linear



Curve



7. Tap ESC button to save in memory and back to step 1.

1 1 2 3 4 5 6

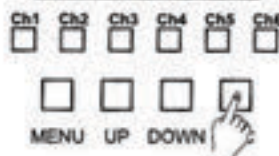

8. Secondly tap ESC button to return to Default Menu.

Features

Thank you for your purchase. This product features include:

- 6 channel digital dimmer pack with Terminal Strips for output, 20A max per individual channel.
- Separate DMX addressing for each channel ,Start and Independ address setting modes selectable.
- Each channel can be programmed with the DMX address, and Max/Min intensity level of the lamps.
- 12 chase programs can be recalled as required, chase velocity is adjustable.
- Built-in chase programs01-12, DMX LastHold, Analogue can be selectable in the event that DMX failure.
- Control curve can be selectable from Linear/S-curve/Non Dim/Square.
- Analogue input works without any adjustment.
- The short circuit protection for each channel with the use of 20A circuit breaker.
- LCD shows clear menu and vivid dynamic images.
- Electronic protection against over temperature and short circuits.
- Cooling Fan & Circle Filter Coil.
- Single Phase & Three Phases Connection allowed.
- Power Failure Memory.

General Instructions

Please read through this operating instructions before installing or using your new product. After you have finished reading the instructions, put them away in a safe place for future reference.

⚠ WARNING!

- This product must be earthed.
- To prevent fire or shock hazard, do not expose this product under high temperature or moisture area.
- Do not make any inflammable liquids, water or metal objects enter the unit.
- No user serviceable parts inside, do not attempt repairs. Should you product fail, contact your local dealer.

⚠ CAUTION!

- This product is intended for indoor use only.
- Provide occasional ventilation, shade and dry during use.
- Disconnect the power when not use for extended period.
- Do not use the unit in places subject to excessive humidity, vibration or bumps.
- Do not dismantle or modify the unit.
- When using Three Phases Connection, L & N wires must connected securely.

***Special Note:**

For reducing signal errors and avoiding signal transmission problems and interference, it is always advisable to connect 120 ohm impedance DMX signal cable and DMX terminator for signal connection.

2. Menu System

2.2.5 Curve

1. Tap UP/DOWN button to scroll to Curve menu.

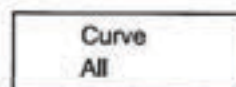
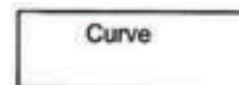

2. Tap MENU button to enter sub-menu system.

3. Tap UP/DOWN button to scroll to All/Single menu, and tap MENU button to enter All/Single mode.

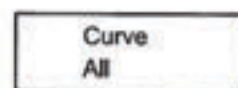

+

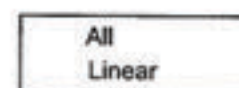

4. In All mode, tap UP/DOWN button to select from Linear/S-Curve/Non Dim/Square.

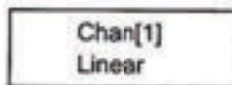

5. In Single mode, tap MENU to select between channel and Linear/S-Curve/Non Dim/Square.

2. Menu System

2.2.4 MinLevel

4. In All mode, tap UP/DOWN to select MinLevel value of all channels between 000%-030%.

All
000%



Chan[1]
000%



5. In Single mode, tap MENU to select between channel and MinLevel value.

6. When channel is activated, tap UP/DOWN button to select from [1-6]; when MinLevel value is activated, tap UP/DOWN button to select from [000%-030%].

Chan[1]
000%



MinLevel

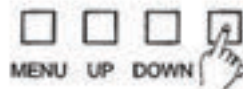

7. Tap ESC button to save in memory and back to step 1.

1. Overview

1.1 Front View



1. Overview

1.1 Front View

1. 2x8 LCD Display

Shows the current activities or adjustments of menus.

2. Channel LEDx6

These LEDs show the activities of corresponding channels.

3. DMX LED

This LED blinks when DMX signal is present.

4. Channel Buttonx6

These buttons are used to change the intensity of corresponding channel.

5. MENU Button

Tap this button to enter default menus or sub-menus.

6. UP/DOWN Button

Tap UP/DOWN button to scroll through or adjust desired levels, menu options during operation.

7. ESC Button

Tap this button to enter or leave menu setting or save setting parameters. In Beginning menu, this button is used to reverse the change direction of channel setting.

8. Circuit Breakerx6(20A per)

2. Menu System

2.2.3 MaxLevel

- When channel is activated, tap UP/DOWN button to select from [1-6]; when MaxLevel value is activated, tap UP/DOWN button to select from [070%-100%].

Chan[1]
070%



MaxLevel



- Tap ESC button to save in memory and back to step 1.

2.2.4 MinLevel

- Tap UP/DOWN button to scroll to MinLevel menu.

MinLevel



MinLevel
All



- Tap MENU button to enter sub-menu system.

- Tap UP/DOWN button to select between All/Single mode, and tap MENU to enter All/Single mode.

MinLevel
All

+

All
030%



2. Menu System

2.2.3 MaxLevel

1. Tap UP/DOWN button to scroll to Maxlevel menu.

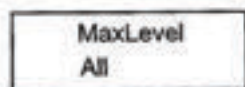
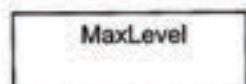

2. Tap MENU button to enter sub-menu system.

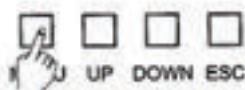

3. Tap UP/DOWN button to select between All/Single mode, and tap MENU to enter All/Single mode.

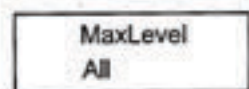

+

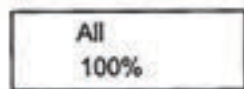

4. In All mode, tap UP/DOWN to select MaxLevel value of all channels between 070%-100%.

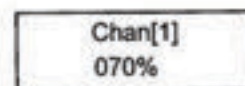
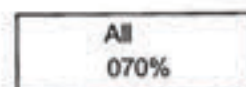

5. In Single mode, tap MENU to select between channel and MaxLevel value.



1. Overview

1.1 Rear View

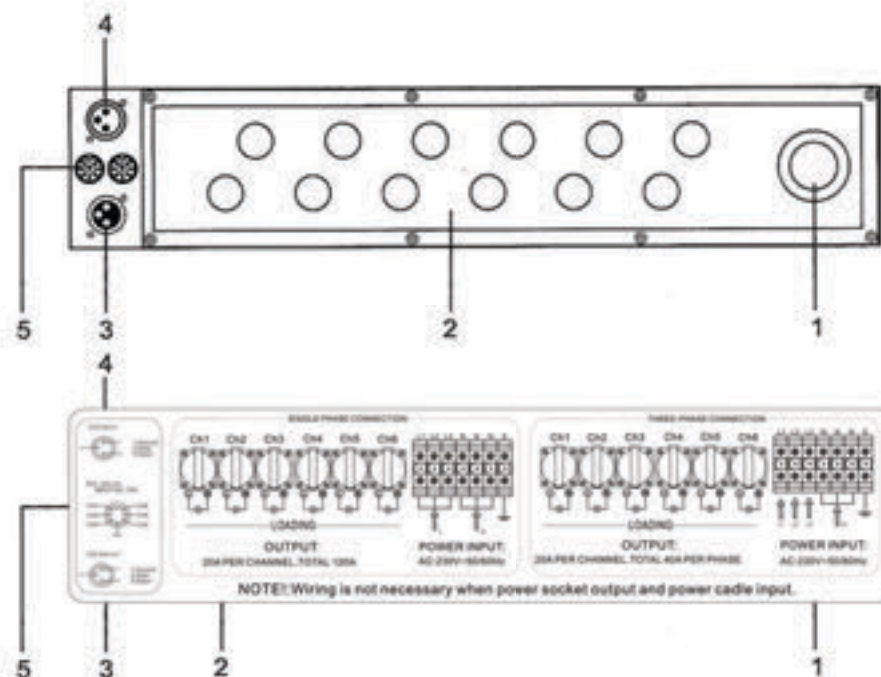

1. Power Input
AC 230V-50/60Hz, 120A max.
2. Terminal Output
Single phase: 20A/CH., Total 120A
Three phase: 20A/CH., Total 40A/Phase
3. DMX OUTPUT
This connector sends DMX signal through to the next DMX device.
4. DMX INPUT
This connector accepts DMX input signal.
5. Analogue Input
DC 0-10V pulse signal.

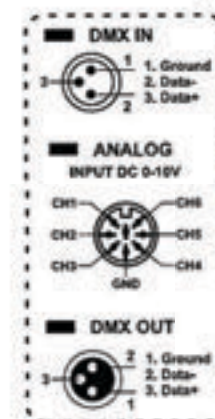

(For details, please refer to the wiring diagram printed on the top cover.)

1. Overview

1.3 Wiring Diagram

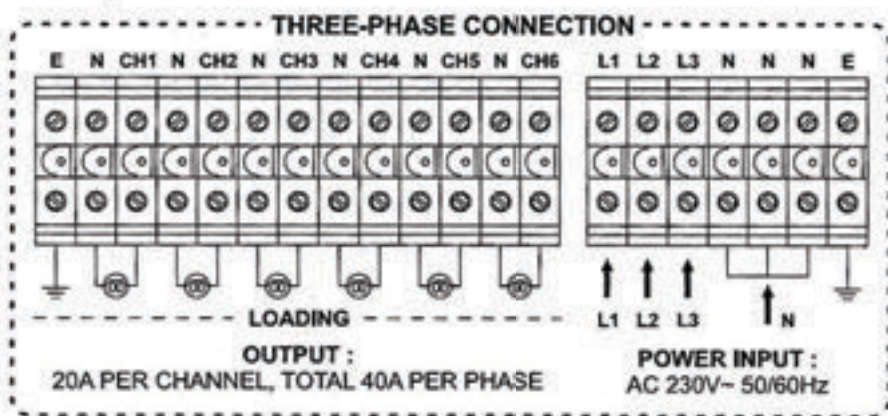
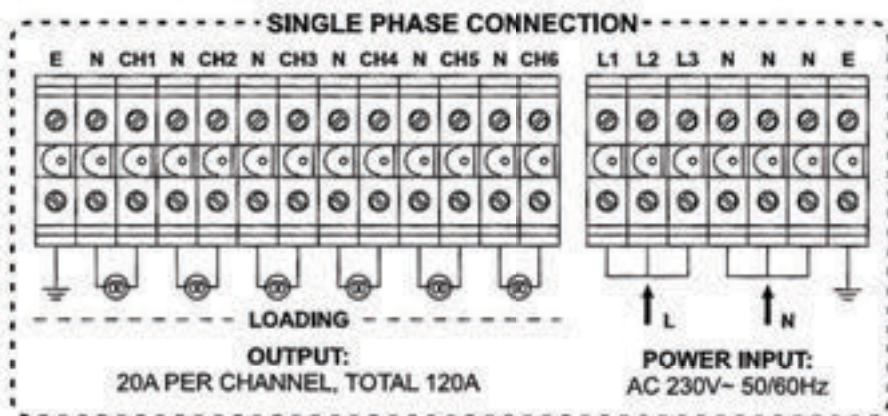

SINGLE PHASE	POWER INPUT: _____AC 230V~ 50-60Hz, 120A MAX OUTPUT: _____20A /CH, Total 120A.	<p>CAUTION Risk of Electric Shock Disconnect Input Power Before Opening</p> <p>⚠ N'ouvrez pas...risque de choc électrique Warning :This apparatus must be earthed ⚡</p> <p>MADE IN P.R.C.</p>
THREE PHASE	POWER INPUT: _____AC 230V~ 50-60Hz, 120A MAX OUTPUT: _____20A/CH, Max 40A/Phase.	
<p>⚠ 1. Either three-phase four-wire input or single phase input is allowed. 2. When single phase input, L1, L2, L3 must be short-circuited via wires. 3. When three phase input, neutral wire must be securely connected.</p>		

2. Menu System

2.2.2 DMX Fail

1. Tap UP/DOWN button to scroll to DMX Fail menu.

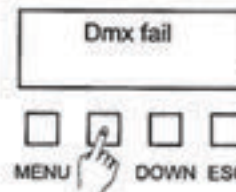

2. Tap MENU button to enter sub-menu system. You can use UP/DOWN button to select LastHold/Analog/Progr:01-12.

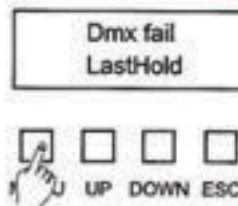

- [LastHold]: Last received DMX signal is held.
 [Analog]: The analogue input(0-10v) is activated.
 [Progr:01-12]: Starts built-in programs 01-12 automatically.

3. If you select LastHold or Analog, you can tap ESC button to save.

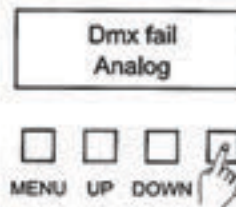

4. If you select Progr:01-12, tap ESC button, velocity menu is activated,.

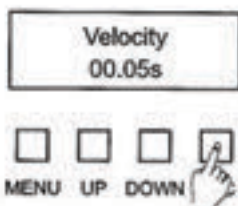

5. You can select the chasing velocity from 00.05s to 30.00s using UP/DOWN button.

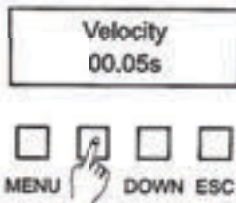

6. After you've finished your setting, tap ESC button to save in memory and back to step 1.

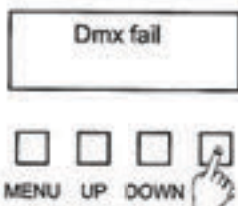

1. Overview

2.2.1 Patching

7. In Single Mode, tap MENU to select between channel and address.

In Single mode, the DMX address of each channel can be selectable separately.



8. When channel is activated, tap UP/DOWN button to select from [1-6]; when address is activated, tap UP/DOWN button to select from [001-512].

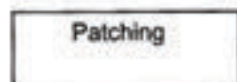

9. Tap ESC button to save in memory and back to step1.

2. Menu System

2.1 Default Menu

Apply power to this unit, firstly the LCD reads the revision of software, then Default Menu is displayed. Default Menu consists of a row of dynamic images and a row of characters, the first row represents the intensity value, and the second row indicates the channel.



2.1.1 Adjust channel intensity temporarily

Tap the channel button to select desired channel intensity, each tap will change intensity once.

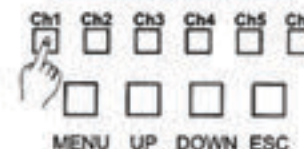

Pressing the button for two seconds changes channel intensity quickly. Tap ESC button, changing direction of channel intensity will be reversed.

2.1.2 Adjust whole intensity temporarily

Tap UP/DOWN button to select desired intensity, each tap will change intensity once.

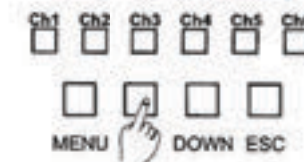

2. Menu System

2.2 Setting Menus

In Default Menu, tap MENU button to enter Setting Menus system.

There are 5 menus: Patching, DMX Fail, MaxLevel, MinLevel and Curve, you can use UP/DOWN button to scroll through the menus. Tap ESC button to exit Setting Menus.

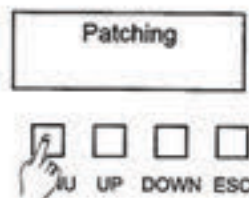

2.2.1 Patching

1. Tap UP/DOWN button to scroll to Patching menu.

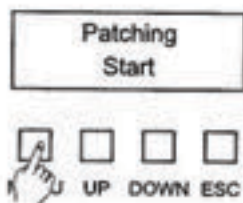
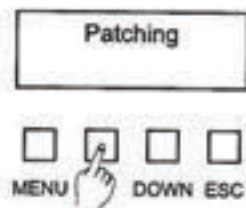

2. Tap MENU button to enter sub-menu system. You can use UP/DOWN button to select Start/Independent.

[Start]: Complete dimmer(6 channels) has only one start address.

[Independent]: The DMX address of each channel is selectable, and all channels can select the same DMX addresses.

2. Menu System

2.2.1 Patching

3. Tap UP/DOWN button to scroll to Start/Independent menu, and tap MENU to enter Start/Independent mode.

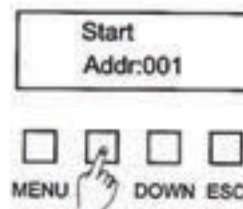
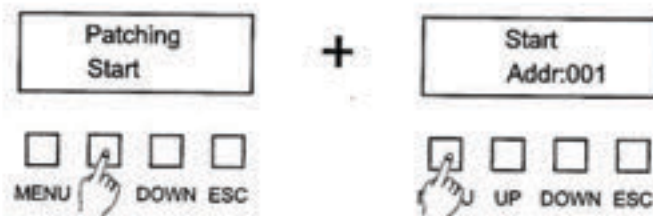

4. In Start mode, you can use UP/DOWN button to select the starting address of 6 channels from [001-512].

5. If you select Independent mode, you can tap UP/DOWN button to scroll to All/Single menu, and tap MENU to enter All/Single mode.

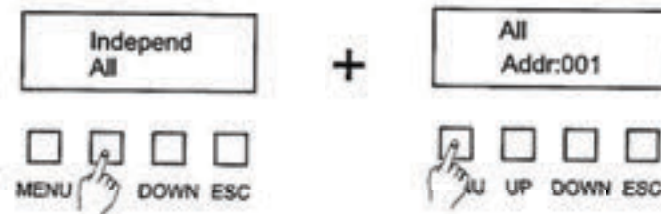

6. In All mode, tap UP/DOWN button to select from [001-512].

In All mode, complete dimmer(6 channels) has only one DMX address.

