

# SHURE®

LEGENDARY  
PERFORMANCE™

Wired Microphones  
Models BETA 53™ and BETA 54™

## Headworn Vocal Microphones

Microphones serre-tête pour la voix

Kopfbügel-Gesangsmikrofone

Micrófonos vocales con diadema

Microfoni con supporto attorno alla testa per voce

Головные вокальные микрофоны

ボーカル用ヘッドウォーンマイクロホン

헤드원 보컬 마이크

多个头戴式人声话筒



**BETA 53**

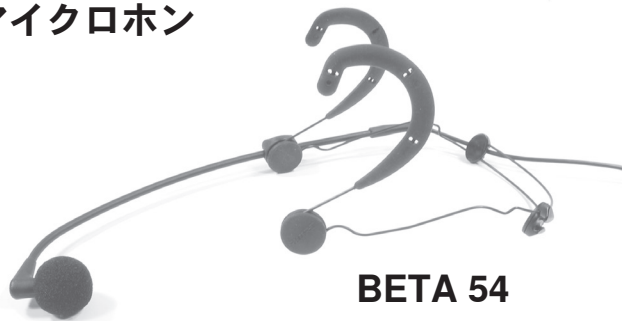

**BETA 54**

©2010 Shure Incorporated  
27A14144 (Rev. 2)  
Printed in U.S.A.



CE

## Introduction

Shure models BETA 53 and BETA 54 are subminiature, electret condenser headworn microphones. They provide uncompromised sound quality and reliability with minimal visibility in applications such as broadcast, theater, and touring. Despite their small size, each microphone's condenser element delivers full, clear, and natural reproduction of speech and vocals. The microphone features a durable, low-profile wire frame headband which is fully adjustable for stability and comfort. A plastic carrying case protects the microphone and its accessories.

### **BETA 53 Features**

- Omnidirectional polar pattern for minimal handling noise and flexible microphone placement
- Extended, flat frequency response provides accurate speech and vocal reproduction
- Two interchangeable protective caps for response shaping
- Foam windscreens minimize breath noise and "popping"
- Available with an in-line preamp or with a TA4F connector for wireless applications
- Choice of black or tan finish to suit your performance environment

### **BETA 54 Features**

- Supercardioid polar pattern provides maximum gain-before-feedback and ambient rejection
- Extended frequency response tailored for vocal performances
- Able to handle extremely high sound pressure levels (SPL)
- Snap-fit foam windscreens stay in place during intensive movement
- Available with an in-line preamp or with a TA4F connector for wireless applications
- Choice of black or tan finish to suit your performance environment

## Available Models

### Beta 53 Models

- Omnidirectional
- For broadcast and stage
- Black finish
- Detachable in-line preamp for wired applications
- Requires phantom power

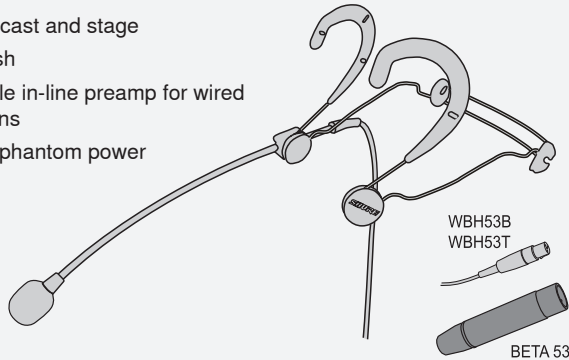

#### Wireless Models

These models are for use with Shure wireless microphone systems. TA4F connector attaches to wireless bodypacks (in-line preamp not included).

- WBH53B (black)
- WBH53T (tan)

#### Accessories

All models include: microphone and headband (1 each), foam windscreens (2), standard protective cap (2), filtered protective cap (2), swiveling lapel clip (1), boom holder (2), logo pad (1) and plastic carrying case (1).

### Beta 54 Models

- Supercardioid
- For stage and vocal performance
- Black finish
- Detachable in-line preamp for wired applications
- Requires phantom power

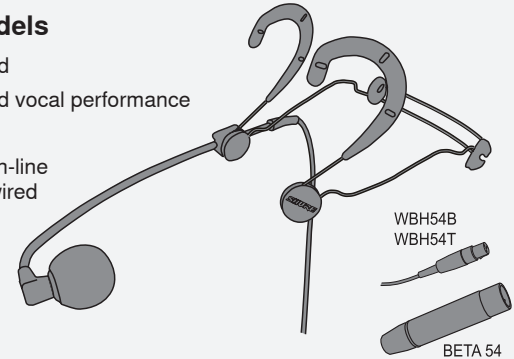

#### Wireless Models

These models are for use with Shure wireless microphone systems. TA4F connector attaches to wireless bodypacks (in-line preamp not included).

- WBH54B (black)
- WBH54T (tan)

#### Accessories

All models include: microphone and headband (1 each), snap-fit foam windscreens (2), standard protective cap (2), swiveling lapel clip (1), boom holder (2), logo pad (1) and plastic carrying case (1).

## Adjusting the Headband and Microphone

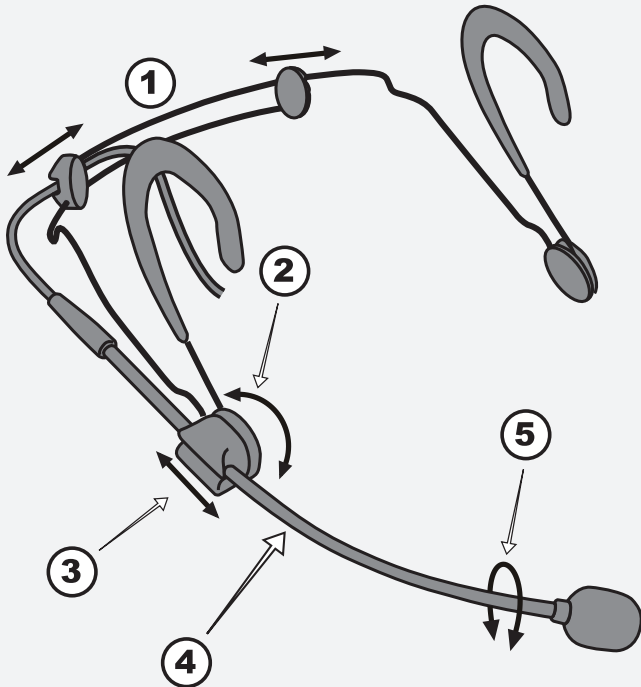

①	Adjust headband width
②	Adjust boom height
③	Adjust boom length
④	<b>Do not attempt to bend the microphone boom!</b>
⑤	"Roll" the boom for subtle adjustments of microphone position

## Using the Windscreens and Protective Caps

### Care and Maintenance

- Foam windscreens may be cleaned with soap and water.
- For the best sound quality, replace damaged or clogged protective caps and windscreens.

### Windscreen

Grip the internal frame of the windscreen firmly when connecting or removing. **Do not pull on the foam itself.**

- To connect, push the windscreen until it snaps into place over the cartridge.
- To remove, pull the windscreen directly off of the cartridge.

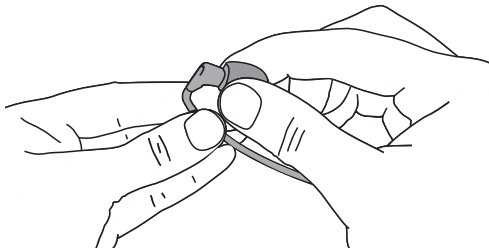

### Protective Caps

Standard protective cap:

- Gold mesh
- No attenuation

Filtered protective cap:

- Silver mesh
- Attenuates high frequencies

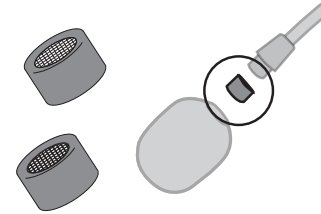

**Important:** Always use the BETA 54 with the standard protective cap only. Using the microphone with no cap, or with the filtered cap, will degrade sound quality and alter the microphone's polar pattern.

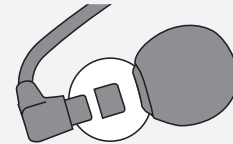

## Positioning the Microphone



### BETA 53

- Position the omnidirectional BETA 53 microphone near the corner of the mouth
- If necessary, roll the boom to avoid contact with skin and facial hair



### BETA 54

- Point the directional BETA 54 microphone at the corner of the mouth



## Wearing the Microphone on Either Side

The microphone boom may be reinstalled to position it on the left or right side of the head.

- Carefully detach the boom holder ①, logo pad ②, and microphone cable ③ from the headband.
- Reattach the boom holder to the opposite side of the wire frame ④.
- Reattach the logo pad ⑤ and microphone cable ⑥.

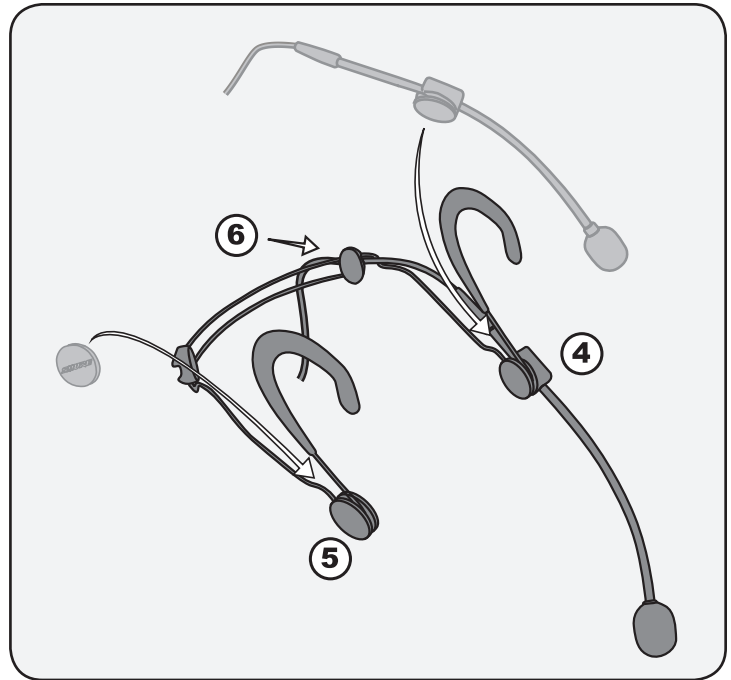
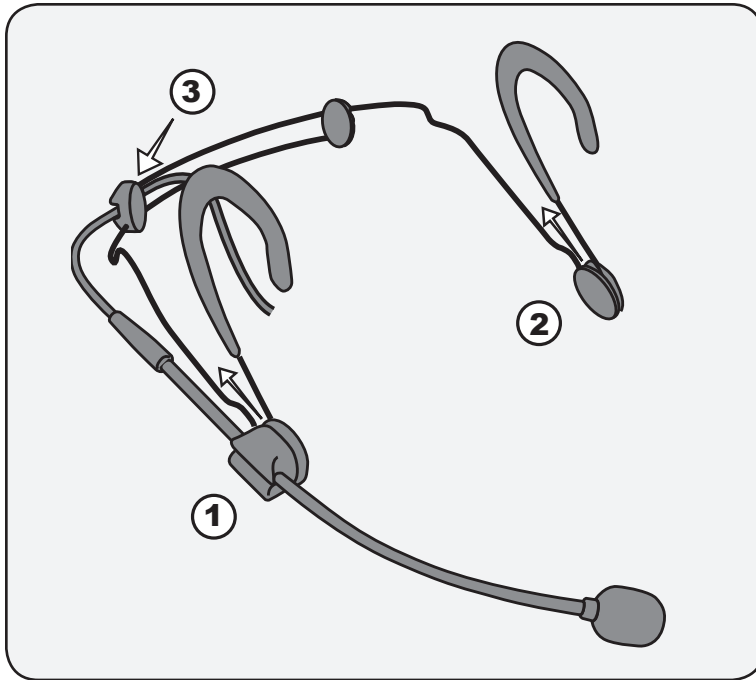

## BETA 53 Replacement Parts and Accessories

	Component	Black	Tan
①	Foam Windscreen (5 pieces)	RPM304	RPM306
②	Standard Protective Cap (gold mesh) (5 pieces)	RPM208	RPM212
	Filtered Protective Cap* (silver mesh) (5 pieces)	RPM220	RPM214
③	Microphone/Boom Assembly with TA4F Connector (1 piece)	RPM132	RPM134
④	Swiveling Lapel Clip (5 pieces)	RPM510	RPM512
⑤	Boom Holder and Logo Pad (2 each)	RPM570	RPM580
⑥	Headband (1 piece, with boom holder and logo pad)	RPM550	RPM560
⑦	4-Pin Mini Connector (TA4F) (1 piece)	WA331**	
⑧	In-Line Preamp (1 piece)	RPM626**	

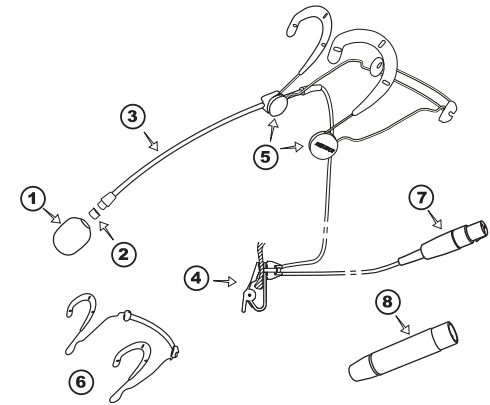

\*See the frequency response curve on page 74

\*\*Available in black only



## BETA 54 Replacement Parts and Accessories

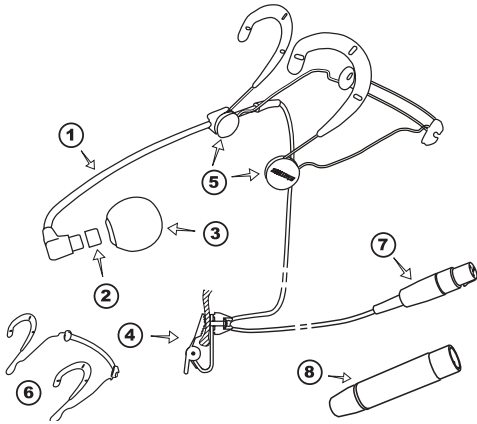

	Component	Black	Tan
①	Microphone/Boom Assembly with TA4F Connector (1 piece)	RPM646	RPM648
②	Standard Protective Cap (gold mesh) (5 pieces)	RPM208	RPM212
③	Snap-fit Foam Windscreen (4 pieces)	RPM316	RPM318
④	Swiveling Lapel Clip (5 pieces)	RPM510	RPM512
⑤	Boom Holder and Logo Pad (2 each)	RPM570	RPM580
⑥	Headband (1 piece, with boom holder and logo pad)	RPM550	RPM560
⑦	4-Pin Mini Connector (TA4F) (1 piece)	WA331*	
⑧	In-Line Preamp (1 piece)	RPM626*	

\*Available in black only

# Wiring Diagram

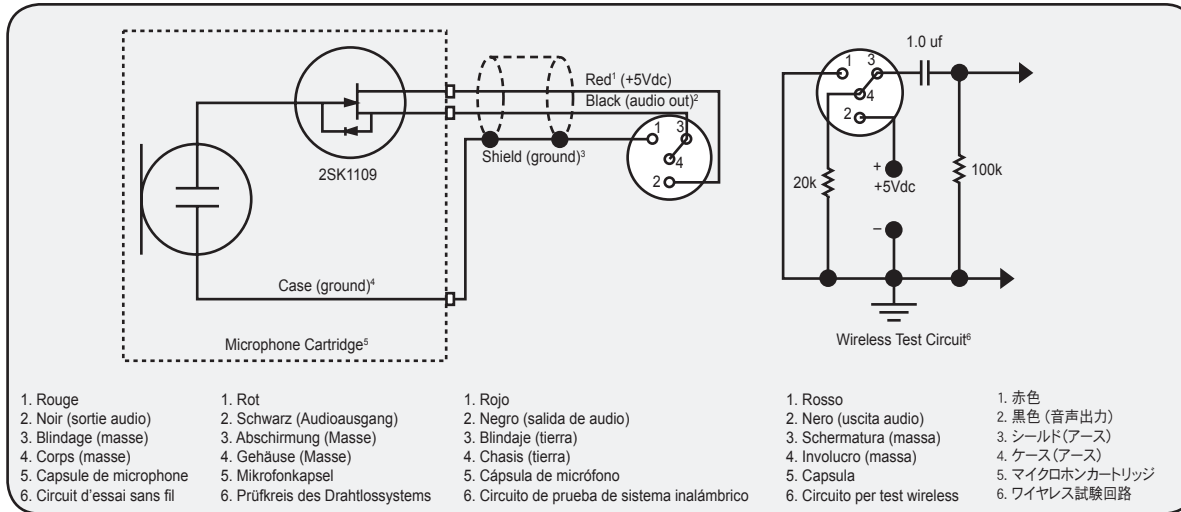

## BETA 53

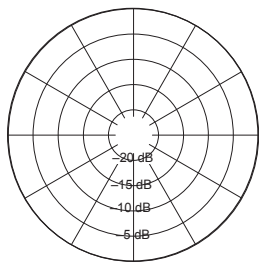

----- 250 Hz  
 - - - - - 500 Hz  
 \_\_\_\_\_ 1000 Hz

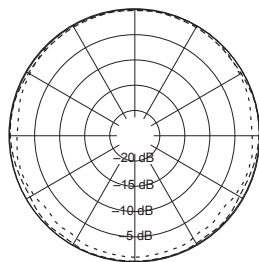

\_\_\_\_\_ 2.5 kHz  
 - - - - - 6.3 kHz  
 - - - - - 10 kHz

## BETA 54

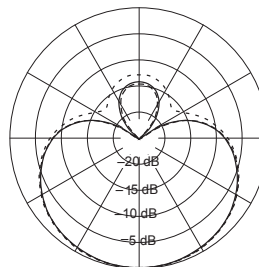

----- 250 Hz  
 - - - - - 500 Hz  
 \_\_\_\_\_ 1000 Hz

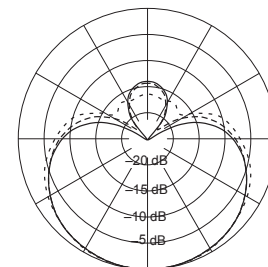

\_\_\_\_\_ 2.5 kHz  
 - - - - - 6.3 kHz  
 - - - - - 10 kHz

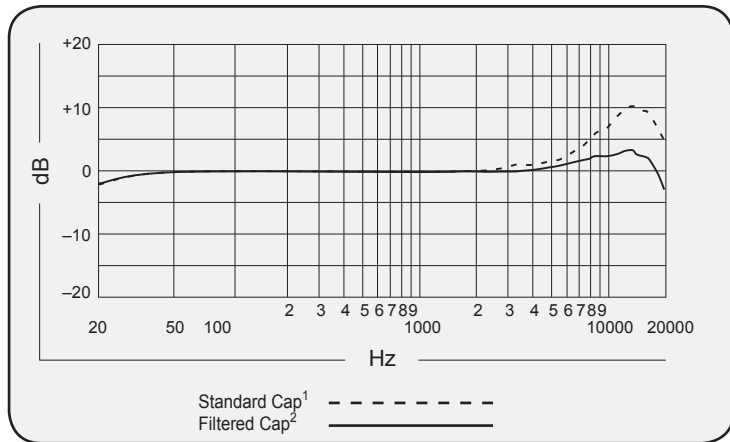

Standard Cap<sup>1</sup> - - - - -  
 Filtered Cap<sup>2</sup> \_\_\_\_\_

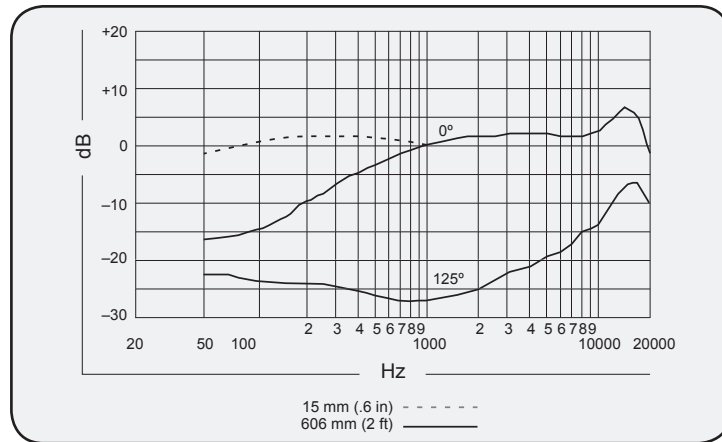

15 mm (.6 in) - - - - -  
 606 mm (2 ft) \_\_\_\_\_

<sup>1</sup> Capuchon standard  
<sup>2</sup> Capuchon à filtre

<sup>1</sup> Standardmäßige Kappe  
<sup>2</sup> Gefilterte Kappe

<sup>1</sup> Tapa estándar  
<sup>2</sup> Tapa con filtro

<sup>1</sup> Cappuccio standard 標準キャップ<sup>1</sup>  
<sup>2</sup> Cappuccio dotato di filtro フィルタ付きキャップ<sup>2</sup>

## CERTIFICATION

Eligible to bear CE Marking. Conforms to European EMC Directive 2004/108/EC. Meets Harmonized Standards EN55103-1:1996 and EN55103-2:1996, for residential (E1) and light industrial (E2) environments.

The Declaration of Conformity can be obtained from:

Authorized European representative:  
Shure Europe GmbH  
Headquarters Europe, Middle East & Africa  
Department: EMEA Approval  
Wannenacker Str. 28  
D-74078 Heilbronn, Germany  
Phone: +49 7131 72 14 0  
Fax: +49 7131 72 14 14  
Email: EMEAsupport@shure.de

## HOMOLOGATION

Autorisé à porter la marque CE. Conforme à la directive européenne CEM 2004/108/CE. Conforme aux normes harmonisées EN55103-1:1996 et EN55103-2:1996 pour les environnements résidentiels (E1) et d'industrie légère (E2).

La déclaration de conformité peut être obtenue de l'adresse suivante:

Représentant agréé européen :  
Shure Europe GmbH  
Siège Europe, Moyen-Orient et Afrique  
Homologation EMEA  
Wannenacker Str. 28  
D-74078 Heilbronn, Germany  
Phone: +49 7131 72 14 0  
Fax: +49 7131 72 14 14  
Email: EMEAsupport@shure.de

## CERTIFICACIONES

Califica para llevar la marca CE. Cumple con la directiva europea de EMC 2004/108/EC. Satisface las normas armonizadas EN55103-1:1996 y EN55103-2:1996 para entornos de uso residencial (E1) e industrial ligero (E2).

La declaración de conformidad se puede obtener de la siguiente dirección:

Representante autorizado en Europa:  
Shure Europe GmbH  
Casa matriz para Europa, Medio Oriente y Africa  
Aprobación para región de EMEA  
Wannenacker Str. 28  
D-74078 Heilbronn, Germany  
Phone: +49 7131 72 14 0  
Fax: +49 7131 72 14 14  
Email: EMEAsupport@shure.de

## ZERTIFIZIERUNG

Zur CE-Kennzeichnung berechtigt. Entspricht der europäischen Richtlinie zur elektromagnetischen Verträglichkeit 2004/108/EG. Entspricht den Anforderungen der harmonisierten Normen EN55103-1:1996 und EN55103-2:1996 für Wohngebiete (E1) und Leichtindustriegebiete (E2).

Die Konformitätserklärung ist über die unten stehende Adresse erhältlich:

Bevollmächtigter Vertreter in Europa:  
Shure Europe GmbH  
Headquarters Europe, Middle East & Africa  
Abteilung: EMEA-Zulassung  
Wannenacker Str. 28  
D-74078 Heilbronn, Germany  
Tel: +49 7131 72 14 0  
Fax: +49 7131 72 14 14  
Email: EMEAsupport@shure.de

## OMOLOGAZIONI

Contrassegnabile con il marchio CE. Conforme alla direttiva europea sulla compatibilità elettromagnetica 2004/108/CE. Conforme alle norme armonizzate EN55103-1:1996 ed EN55103-2:1996 per l'uso in ambienti domestici (E1) e industriali leggeri (E2).

La dichiarazione di conformità può essere ottenuta da:

Rappresentante europeo autorizzato:  
Shure Europe GmbH  
Sede per Europa, Medio Oriente e Africa  
Approvazione EMEA  
Wannenacker Str. 28  
D-74078 Heilbronn, Germany  
Phone: +49 7131 72 14 0  
Fax: +49 7131 72 14 14  
Email: EMEAsupport@shure.de

## СЕРТИФИКАЦИЯ

Соответствует требованиям для нанесения маркировки CE. Соответствует требованиям европейской директивы 2004/108/ЕЕС по ЭМС. Соответствует требованиям гармонизированных стандартов EN55103-1:1996 и EN55103-2:1996 для жилых районов (E1) и районов с легкими промышленными условиями (E2).

Заявление о соответствии можно получить по следующему адресу:

Уполномоченный европейский представитель:  
Shure Europe GmbH  
Headquarters Europe, Middle East & Africa  
Department: EMEA Approval  
Wannenacker Str. 28  
D-74078 Heilbronn, Germany (Германия)  
Телефон: +49 7131 72 14 0  
Факс: +49 7131 72 14 14  
Эл. почта: EMEAsupport@shure.de