

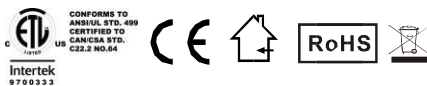

W-515D/W-530D

Fog Machine User Manual



English · Français · Deutsch

©2015 Antari Lighting and Effects Ltd.



User Manual

W-515D & W-530D Fog Machine

Congratulations on the purchase of your new ANTARI
W-Series FOG MACHINE.

Introduction

Thank you for choosing an ANTARI W-Series Fog Machine. You now own a rugged and powerful state-of-the-art machine. Prior to use, we suggest that you carefully read all of the instructions. By following the suggestions found in this user manual, you can look forward to the reliable and satisfactory performance of your ANTARI Fog Machine for years to come.

Please follow these operation, safety and maintenance instructions to ensure a long and safe life for your fog machine.



CAUTION:

Risk of electric shock. Disconnect the appliance from the electric supply before refilling liquid, cleaning or performing maintenance on the machine.

Danger of Electric Shock

- Keep this device dry.
- Indoor use only. Not designed for outdoor use.
- For all models, use 3-prong grounded electrical outlet only. Prior to use, take care to determine that the unit is installed at the rated voltage.
- Always unplug your ANTARI W-Series Fog Machine before filling its tank.
- Always keep fog machine in upright position.
- Turn off or unplug the machine when not in use.
- This machine is not water-proof. If moisture, water, or fog fluid gets inside the housing, immediately unplug the unit and contact a service technician or your ANTARI dealer before using it again.
- No user serviceable parts inside. Refer to your ANTARI dealer or other qualified service personnel.



Danger of Burns

- This device is for adult use only and must be installed out of the reach of

- children. Never leave the unit running unattended.
- Never aim the output nozzle directly at people.
 - Fog machine output is very hot. Avoid coming within 50 cm of the output Nozzle during operation.
 - Locate the fog machine in a well-ventilated area. Never cover the unit's vents. In order to guarantee adequate ventilation, allow a free air space of at least 20 cm around the sides and top of the unit.
 - Never aim the output nozzle at open flames.
 - If the supply cord is damaged, it must be replaced by manufacturer or its service agent or similarly qualified personnel in order to avoid a hazard.
 - The output nozzle becomes very hot during operation (200°C). Keep flammable materials at least 50 cm away from the nozzle.
 - Always allow your ANTARI Fog Machine to cool down before attempting to clean or service it.



Danger of Explosion

- Never add flammable liquids of any kind (such as oil, gas, perfume) to the fog liquid.
- Use only high-quality, water-based fog liquid that your dealer recommends. Other fog liquids may cause clogging or "spitting".
- Always make sure there is sufficient liquid in the tank. Operating this unit without liquid might cause damage to the pump as well as over-heating of the heater.
- If your ANTARI W-515D or W-530D Fog Machine fails to work properly, discontinue use immediately. Drain all fog liquid from the tank, pack the unit securely (preferably in the original packing material), and return it to your ANTARI dealer for service.
- Always drain tank before mailing or transporting this unit.
- Never drink fog liquid. If it is ingested, call a doctor immediately. If fog liquid comes in contact with skin or eyes, rinse thoroughly with water.

Note: Pay attention to all warning labels and instructions printed on the exterior of your ANTARI Fog Machine.

Unpacking & Inspection

Open the shipping carton and verify that all equipment necessary to operate the system has arrived intact.

The shipping carton should contain the following items:

1. One unit of W-515D or W-530D Fog Machine
2. Power cord
3. One Set of W-1 transmitter
4. User Manual

If any equipment is missing, contact your ANTARI dealer immediately.

Before beginning your initial setup on ANTARI W-515D & W-530D Fog Machine, make sure that there is no evident damage caused by transportation. In the event that the unit's housing or cable is damaged, do not plug it in and do not attempt to use it until after contacting your ANTARI dealer for assistance.

Setup

- Remove all packing materials from shipping box. Check that all foam and plastic padding is removed, especially in the nozzle area.
- Place fog machine on a flat surface and remove fog liquid tank cap.
- Place the liquid tube into a properly filled liquid tank.
- Fill with high-quality, water-based fog liquid recommended by ANTARI dealer.
- The W-515D or W-530D only works with uncontaminated Antari FLR or FLG Fog Liquid. Any other types of liquid can damage the unit resulting in spitting and serious clogging problem. When filled, place cap back on liquid tank. Be careful not to exceed the maximum fluid level. DO NOT OVERFILL.

Operation

Control Panel

The built-in control panel on the rear of the machine features an LCD panel displaying all operation status of the fog machine. The control panel allows the user to customize fog machine functions by adjusting the fogging duration, interval, and volume as well as the DMX and W-DMX address, the wireless function and the fluid sensor. There are 4 buttons on the control board. All current operating parameters are automatically stored in non-volatile memory, allowing the machine to be powered down without losing function settings.

After powering on, the display shortly indicates »Antari W-515D/W-530D«. At this time, users may press MENU button and hold for 2 seconds to switch the language for control interface from English to Chinese.

Then the display indicates »Wireless Detect...«. This indication lasts for 15 seconds. Users may register the W-1 wireless transmitter to the fog machine by pressing Key A on the W-1 during this period. When the wireless control function is off, this indication won't be shown.

Then the fog machine starts with the warm-up process and the display indicates »Warming Up«. While the unit is warming up, fog output will not be possible yet. Program the necessary menu settings with the control panel. Once the warm-up process is completed, fog output will be possible. The display indicates »Ready to Fog«. Additionally, a »P« for W-DMX, a »W« for wireless or an »S« for fluid sensor is indicated if these functions are activated.

- Menu settings with the button MENU

• Setting time intervals for timer operation

Press the button MENU until the display indicates »Interval Set«. Use the buttons UP and DOWN to adjust the intervals between the individual fog

outputs in timer mode within the range of 5 and 200 seconds.

• **Setting the output duration for timer operation**

Press the button MENU until the display indicates »Duration Set«. Use the buttons UP and DOWN to adjust the duration of the fog outputs in timer mode within the range of 1 and 200 seconds.

• **Setting the fog output volume for timer operation**

Press the button MENU until the display indicates »Timer Output«. Use the buttons UP and DOWN to adjust the fog output volume in timer mode within the range of 1 % and 100 %.

• **Setting the fog output volume for continuous operation**

Press the button MENU until the display indicates »Volume Output«. Use the buttons UP and DOWN to adjust the fog output volume in continuous mode within the range of 1 % and 100 %.

To set the unit to continuous fog output in continuous mode, select »NON STOPBURST« below a value of 1 % or above a value of 100 %.

NOTE:

When setting a fog output volume higher than 30 % for continuous operation, the fog machine occasionally needs to stop the fog output to reheat. When »NONSTOPBURST« is selected, the fog machine adjusts the fog output volume and heater temperature automatically and does not need to stop the fog output to reheat.

• **Setting the DMX512 address**

Press the MENU until the display indicates »DMX512 Address: 001«. Use the buttons UP and DOWN to set the machine to the same address as on your DMX controller. Please refer to chapter DMX512 settings for more information on DMX operation.

• **Switching the wireless function on and off**

Press the button MENU until the display indicates »Wireless ON«. Use the buttons UP and DOWN to deactivate the wireless function (indication »Wireless OFF«) and to reactivate it (indication »Wireless ON«).

• **Switching the fluid sensor on and off**





Press the button MENU until the display indicates »Fluid Sensor Set ON«. Use the buttons UP and DOWN to deactivate the fluid sensor (indication »Fluid Sensor Set OFF«) and to reactivate it (indication »Fluid Sensor Set ON«).

• **Switching the W-DMX function on and off**

Press the button MENU until the display indicates »W-DMX Power ON«. Use the buttons UP and DOWN to deactivate the W-DMX function (indication »W-DMX Power OFF«) and to reactivate it (indication »W-DMX Power ON«).

Note:

When W-DMX function is activated, the connection status will be shown on display by below symbols.

Status of W-DMX connection	Symbol on the Liquid Crystal Display
Transmitter assigned, DMX signal received	
Transmitter assigned, No DMX signal	
Transmitter link lost or linking to transmitter	
Transmitter not assigned	

• Setting W-DMX 512 address

When W-DMX function is activated, press button MENU until the display indicates »W-DMX Address: 001«. Use the buttons UP and DOWN to set the machine to the same address as on your W-DMX console.

• Resetting W-DMX connection

When W-DMX function is activated, press button MENU until the display indicates »W-DMX Reset OFF«. Use the buttons UP and DOWN to activate the resetting: delete previous W-DMX connection and relink. Once the deletion and relink are done, the display indicates »W-DMX Reset OFF« again.

• Switching the run last setting function on and off

Press the button MENU until the display indicates »Run Last Setting ON«. Use the buttons UP and DOWN to deactivate the run last setting function (indication »Run Last Setting OFF«) and to reactivate it (indication »Run Last Setting ON«).

- Continuous operation

Press the button VOLUME, to activate continuous fog output. The display indicates »Volume Output« followed by the value that was set in menu item »Volume Output« or »NONSTOPBURST« when continuous fog output was selected. To stop the fog output, press STOP button.

NOTE:

When a fog output volume higher than 30 % was set for continuous operation, the fog machine occasionally needs to stop the fog output to reheat. When »NONSTOPBURST« was selected, the fog machine adjusts the fog output volume and heater temperature automatically and does not need to stop to reheat.

- Timer operation

In the timer mode, the fog machine will automatically emit fog. The time intervals, duration and fog volume depend on the corresponding menu settings. Press the button TIMER to activate the timer mode. The display indicates the set time interval. The unit counts down to 0 seconds and emits fog. To deactivate the timer mode, press STOP button.

W-1 Wireless Remote

The wireless remote control system W-1 consists of a transmitter equipped with two buttons for fog on and off, and a receiver pre-attached to the rear panel of each W-series model.

*** Transmitter:**



With the transmitter it is possible to emit fog via radio over a distance of up to 50 meters. The transmitter is compatible to any receiver of the W-series and can control an unlimited number of machines in parallel.

Press the button "A", to emit fog. The button "A" has the same function as the button VOLUME on the control panel, i.e. the fog output depends on the setting of menu item »Volume Output«. The display indicates »Volume« followed by the defined value or »NONSTOPBURST« when continuous fog output was selected. As additional control, the blue LED light. To stop the fog output, press the button "B".

*** Receiver:**



The receiver is tested and pre-attached to the rear panel of each W-series model. Please do not try to remove it. The receiver responds to up to 5 different transmitters that are registered with the machine. The included transmitter has been registered to the machine before shipment. It can be directly operated without any start-up setting.

- Registering transmitters

To operate the machine with a different transmitter than the included one, or to operate it with up to 5 different transmitters, each transmitter must be registered first. For this purpose, turn on the machine. When the display indicates »Wireless Detect...«, press the button "A" 1 second on each transmitter. Thus the previous transmitters are cleared from the memory of the receiver. The setting must be completed within 15 seconds at indication »Wireless Detect...«.

If no transmitter is registered when the machine is switched on, the memory of the receiver will keep the record of the previous operation.

Setting Example 1:

In order to register several transmitters with a machine, turn on the machine. When the display indicates »Wireless Detect...«, press the button "A" 1 second on each transmitter within 15 seconds to establish the signal transmission.

Setting Example 2:

In order to use 1 transmitter to control 2 or more machines, turn on the

machines at the same time. When the displays indicate »Wireless Detect...«, press the button "A" 1 second on the transmitter within 15 seconds to establish the signal transmission.

- Battery change on the transmitter

If the range of the transmitter decreases, the battery is probably exhausted and must be replaced. For this purpose, take off the housing cover and remove the used battery. Insert a fresh 12 V battery, type 27A as indicated in the battery compartment and refit the housing cover.

DMX Connector Pin Assignment

The machine provides 3 or 5 pin XLR connector for DMX connection. Diagram below indicate pin assignment information

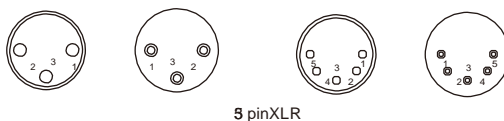

Pin	Function
1	Ground
2	Data-
3	Data+

DMX512 Settings

Channel A



0 - 5 = off (no output)

6 - 255 = output volume control (1 - 100 % output)

Both models are equipped with a DMX512 system. For connecting a DMX controller, 3-pin and 5-pin male-female XLR connections are provided at the back of each machine. The machines use one control channel for adjusting the output volume. The channel has a DMX value range of 0 to 255. After connecting a DMX controller, timer functions such as output duration and interval can be programmed using the DMX controller or the DMX control software. The machine cannot be controlled via the built-in control panel nor the W-1 wireless remote anymore. By using the DMX protocol, fog machines, lighting effects, and other special effects machines can be interconnected and easily controlled.

If channel A has a value from 0 to 5, the unit is off.

Between the values 6 to 255 the fog output volume is regulated. With 6 being the minimum output volume and 255 approaching the maximum output volume. The output volume rises as the DMX value is increased.

Note: If, for example, the machine is assigned to the DMX address 124, channel A corresponds to DMX address 124.

Note

If you experience low output, pump noise or no output at all, unplug immediately. Check the fluid level, the external fuse, the connection to the remote control, and power from the wall. If all of the above appears to be O.K., plug the unit again. If fog does not come out after holding the remote button down for 30 seconds, check the hose attached to the tank to make sure there is fluid going through the hose. If you are unable to determine the cause of the problem, do not simply continue pushing the remote button, as this may damage the unit. Return the machine to your Antari dealer.

W-515D External View

- 01-Nozzle
- 02-Handle
- 03-Body
- 04-Tank & tank's cap
- 05-PU tube & filter
- 06-Tube adaptor
- 07-Safety ring
- 08-Control outlet socket
(3 Pin XLR for DMX)
- 09-Control inlet socket
(3 Pin XLR for DMX)
- 10-Control outlet socket
(5 Pin XLR for DMX)
- 11-Control inlet socket
(5 Pin XLR for DMX)
- 12-Rocker switch / Power
- 13-Circuit breaker
- 14-Power socket
- 15-W-1 wireless receiver / W-DMX receiver
- 16-Control panel
- 17-Foot
- 18-Power cord
- 19-W-1 wireless transmitter

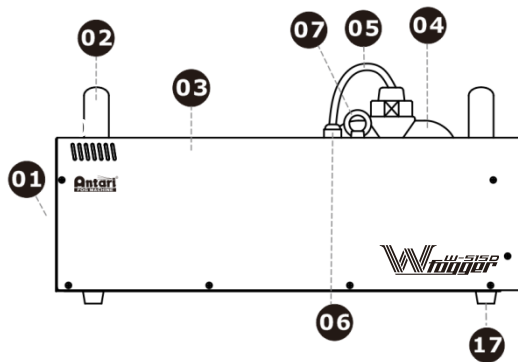

W-530D External View

- 01-Nozzle
- 02-Handle
- 03-Body
- 04-Tank & tank's cap
- 05-PU tube & filter
- 06-Tube adaptor
- 07-Safety ring
- 08-Control outlet socket
(3 Pin XLR for DMX)
- 09-Control inlet socket
(3 Pin XLR for DMX)
- 10-Control outlet socket
(5 Pin XLR for DMX)
- 11-Control inlet socket
(5 Pin XLR for DMX)
- 12-Rocker switch / Power
- 13-Circuit breaker
- 14-Power socket
- 15-W-1 wireless receiver / W-DMX receiver
- 16-Control panel
- 17-Foot
- 18-Power cord
- 19-W-1 wireless transmitter

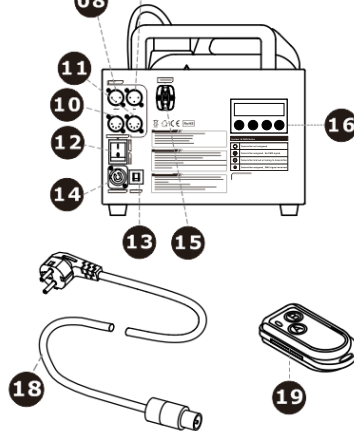
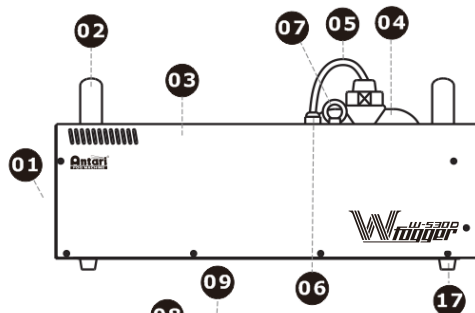
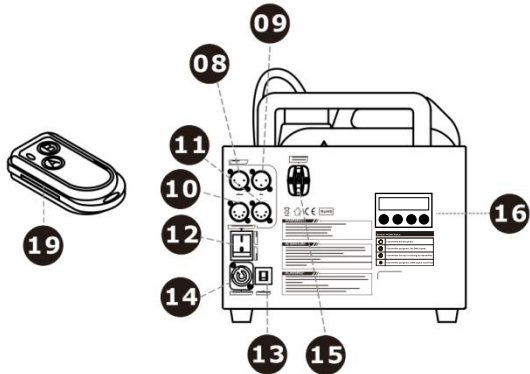

Performance Note

All fog machines develop condensation around the output nozzle. Because this may result in some moisture accumulation on the surface below the output nozzle, consider this condensation when installing your unit.

All fog machines may sputter small amounts of fog occasionally during operation and for a minute or so after being turned off.

All fog machines have a recycling period after long bursts when the machine will shut itself down for a short period in order to heat up again. During this time no fog can be produced.

Cleaning and Storage

Do not allow the fog liquid to become contaminated. Always replace the cap on the fog liquid container and the fog machine liquid tank immediately after filling. Cleaning your fog machine regularly can help you to reduce the frequency of parts replacement and maintenance costs. After every 40 hours of continuous operation, it is recommended to use distilled water to clean the heater according to the steps below.

The recommended cleaning regimen is as follows:

1. Fill properly distilled water into a clean tank and connect the fluid tube of the fog machine to the tank.
2. Run the unit in a well-ventilated area until the tank is almost empty.
3. Use dry cloth to wipe the fog machine. Cleaning is now complete. Refill with fog liquid. Run the machine briefly to clear any remaining liquid from the pump and heater.

Note: All fog machines are prone to clogging due to the thick consistency of fog liquid and the high temperature at which it vaporizes. However, a properly maintained fog machine should provide years of reliable use.

Clean with a dry cloth only. Store dry.

If the fog machine is not in use, please clean it before storage. Store the fog machine in a dry and cool place. Operate the fog machine at least once a month. A test-run consists of warming-up the machine followed by a few minutes of fog emission.

Technical Specifications

Model	W-515D	W-530D
PowerSupply	100~240VAC50/60Hz	100~240VAC50/60Hz
PowerConsumption	1500W	3000W
OutputVolume	20,000cu.ft/min(566m ³ /min)	40,000cu.ft/min(1132m ³ /min)
TankCapacity	6 liters	6 liters
FluidConsumption	10 min/liter	6 min/liter
Warm-upTime	10min	12min
Weight	14.5kg	19kg
Dimensions(LxWxH)	561x 278x 186(mm)	581x 278x 186(mm)
RemoteIncluded	W-1	W-1
Carrierfrequency	433.92 / 315 MHz	433.92 / 315 MHz
Battery	12V, type 27A	12V, type 27A
Range	approx.50m	approx.50m

Approval

This product is in accordance with the R&TTE directive (Radio and Telecommunication Technical Equipment) of the European Union and falls into equipment Class 1. In all EU member countries, the operation of this wireless system is generally approved by the national telecom regulatory authority. The system is license-free. In some countries outside the EU, the operation of this wireless system may need to be approved by the national telecoms regulatory authority.



Warranty

Warranty shall be valid only if the product is purchased from Antari's authorized distributors or dealers. For warranty service, send the product only to an authorized distributor or dealer.

All warranties are void if the product has been modified in any manner; if the product has been repaired or serviced by unauthorized personnel; or the product is damaged due to improper use or maintenance as set forth in the instruction manual.

This is not a service contract and does not include standard maintenance or cleaning. All expendables are not covered by this warranty.

Additional warranties provided at the discretion of the distributor dealers shall remain the sole obligation of the distributor or dealer.

Always quote the unit's serial number and model name when contacting your distributor for information or assistance.

Please read and save these instructions.