



wePresent

User's Manual

For WiPG-2000 (May 2014)

Version: 0.3

Table of Contents

1	OVERVIEW	6
2	PACKAGE CONTENTS	9
3	USB TOKEN CONTENTS	9
4	PHYSICAL DETAILS	10
5	WHAT YOU MIGHT NEED	11
6	QUICK INSTALLATION	12
7	WIPG-2000 START/STANDBY PAGE	13
7.1	QUICK GUIDE / USER-LIST	13
7.2	FEATURE ICONS	13
7.3	REMOTE TOUCH CONTROL (UMT)	15
7.4	CONFERENCE CONTROL MODE	15
7.5	SPLIT SCREEN MODE	16
7.6	DIRECT DRAW	16
7.7	PEN MENU FUNCTION UNDER PROJECTING MODE	17
7.8	USB PLAYER FUNCTION	18
8	DoWiFi FOR WINDOWS	19
8.1	INSTALL THE APPLICATION	19
8.2	START THE APPLICATION	21
8.3	RECENT CONNECTION	21
8.4	CONNECT TO RECEIVER DEVICE	22
8.5	LOGIN	23
8.6	CHANGE TO ANOTHER WiFi NETWORK	23
8.7	MAIN USER INTERFACE	24
8.8	SCREEN PROJECTION	24
8.9	CONNECTED RECEIVER LIST	25
8.10	VIDEO STREAMING	25
8.11	MENU	27
8.11.1	LAUNCH SIDEPAD	27
8.11.2	LAUNCH WEBSLIDES	28
8.11.3	REMOTE CONTROL	30
8.11.4	PROJECTION SOURCE	30
8.11.5	ADVANCED PROJECTION OPTION	31
8.11.5.1	ADVANCED SCREEN CAPTURE	31
8.11.5.2	PROJECTION ASPECT RATIO	32
8.11.5.3	SELECT PROJECTION MODE	32
8.11.5.4	RESOLUTION SETTINGS	33
8.11.5.5	PROJECTION QUALITY	33

8.11.5.6	SCREEN ENCODING FORMAT	33
8.11.6	OTHERS	34
8.11.6.1	AUTO POWER MANAGER	34
8.11.6.2	MAKE USB PNS TOKEN	35
8.11.6.3	COPY APPLICATION TO DESKTOP	35
8.11.6.4	HOT KEY	36
8.11.7	DISCONNECT	36
8.11.8	ABOUT	36
8.11.9	EXIT	36
9	DoWiFi FOR MAC	37
9.1	INSTALL THE APPLICATION	37
9.2	START THE APPLICATION	38
9.3	RECENT CONNECTION	38
9.4	LOGIN	39
9.5	CHANGE TO ANOTHER WiFi NETWORK	40
9.6	MAIN USER INTERFACE	41
9.7	SCREEN PROJECTION	41
9.8	CONNECTED RECEIVER LIST	42
9.9	VIDEO STREAMING	42
9.10	MENU	43
9.10.1	LAUNCH SIDEPAD	43
9.10.2	LAUNCH WEBSLIDES	45
9.10.3	REMOTE DESKTOP	47
9.10.4	SELECT PROJECTION DESKTOP	47
9.10.5	ADVANCED SETTINGS	47
9.10.5.1	PROJECTION ASPECT RATIO	47
9.10.5.2	SELECT PROJECTION MODE	48
9.10.5.3	RESOLUTION SETTINGS	48
9.10.5.4	PROJECTION QUALITY	48
9.10.5.5	SCREEN ENCODING FORMAT	49
9.10.6	OTHERS	49
9.10.6.1	MAKE USB PNS TOKEN	49
9.10.6.2	HOT KEY	50
9.10.7	DISCONNECT	50
9.10.8	ABOUT	50
9.10.9	EXIT	50
10	WEB MANAGEMENT	51
10.1	HOME PAGE	51
10.2	DOWNLOAD	51

10.3	CONFERENCE CONTROL	52
10.4	ADMIN	53
10.5	SYSTEM STATUS	54
10.6	DEVICE SETUP	55
10.7	NETWORK SETUP	56
10.8	WiFi SETUP	58
10.9	SNMP SETUP	60
10.10	OSD SETUP	61
10.11	WEBSLIDES SETUP	62
10.12	CHANGE PASSWORDS	63
10.13	RESET TO DEFAULT	64
10.14	FIRMWARE UPGRADE	64
10.15	REBOOT SYSTEM	65
10.16	LOGOUT	66
10.17	WEBSLIDES	67
11	USB PLAYER	68
11.1	PHOTO VIEWER	69
11.2	VIDEO PLAYER	69
11.3	MUSIC PLAYER	70
11.4	OFFICE VIEWER	71
11.5	SETUP	72

Safety

1. Compliance IC

Canada, Industry Canada (IC) Notices

This Class B digital apparatus complies with Canadian ICES-003 and RSS-210. Operation is subject to the following two conditions: (1) this device may not cause interference, and (2) this device must accept any interference, including interference that may cause undesired operation of the device.

Radio Frequency (RF) Exposure Information

The radiated output power of the AWIND Wireless Device is below the Industry Canada (IC) radio frequency exposure limits. The AWIND Wireless Device should be used in such a manner such that the potential for human contact during normal operation is minimized.

WiPG-1500 IC No.: 11600A-WIPG1500S

Antenna Information and Compliance:

This radio transmitter (IC:11600A-WIPG1500S, or WiPG-1500 if Category II) has been approved by Industry Canada to operate with the antenna types listed below with the maximum permissible gain and required antenna impedance for each antenna type indicated. Antenna types not included in this list, having a gain greater than the maximum gain indicated for that type, are strictly prohibited for use with this device.

Antenna Part Number:AN2400-5791RS, Antenna Type (Dipole), Gain 2.55dBi,
Impedance 50 ohms[Main]

Antenna Part Number:AN2400-5791RS, Antenna Type (Dipole), Gain 2.55dBi,
Impedance 50 ohms[Aux]



Caution: Exposure to Radio Frequency Radiation





To comply with RSS 102 RF exposure compliance requirements, a separation distance of at least 20 cm must be maintained between the antenna of this device and all persons.

1 Overview

WiPG-2000 is a spectacular wireless presentation device which connects multi-platform devices (Windows/Mac/Pad/Smartphone/AirPad) for engaging interactive presentations by supporting finger-touch technology, virtual whiteboard and Win 7/8 HID compatible remote devices.

WiPG-2000 Highlight Features:

Icon	Feature	Description
	DoWiFi	Wireless presentation for Windows and Mac <ul style="list-style-type: none">◆ Win: XP/Vista/7/8,◆ Mac: 10.7/10.8/10.9
	MirrorOp for Galaxy	MirrorOp sender for Samsung Galaxy series devices Support. Users can project any contents from their Samsung Galaxy devices.
	MirrorOp Presenter	High quality presentation and annotation via iPhone/iPad or Android devices (Word, Excel, PPT, PDF , Photo , Browser, Live Camera, Screenshot)
	Video Streaming	Network Video/Music streaming for Windows and Mac.
	WiFi-Doc	High quality presentation via iPhone/iPad or Android devices (Word, Excel, PPT, PDF , Photo , Screenshot)
	SidePad	Control the projecting screen on PC or Mac via iPhone/iPad or Android devices
	WebSlides	Broadcast slides to your devices with WiFi and web browser <ul style="list-style-type: none">◆ Audience can save the projecting slides for taking notes◆ Webslides can be secured by password.
	Direct Draw	<ul style="list-style-type: none">◆ Make free drawing on virtual whiteboard/blackboard without any computer connected

		<ul style="list-style-type: none"> ◆ Make annotation on any projecting content. It allows you to annotate on the screen during the presentation ◆ Annotating, writing and drawing can be done using touch screen, AirPad or any other USB HID device
	4-to-1 projection	Project four PC/Mac screens or WiFi-Doc content to one projector/display at once.
	One to Many Projection	Project the screen to up to four receiver devices at the same time.
	Conference Control / OSD User-List	<p>Control projection from WiPG's web page, or use mouse/keyboard to select a PC from the standby screen.</p> <ul style="list-style-type: none"> ◆ Conference control function can be secured by password ◆ Moderator can control who is projecting. ◆ Moderator can compare 4 screens side by side.
	SNMP V3	Manage WiPG devices across the corporate network through enhanced SNMP V3 protocol
	UMT	Driverless remote touch control through network. (Support standard Win 7/8 compatible USB HID touch device)

Key Features

- High performance screen/audio projection for Windows/Mac (Windows 7/8 and Mac 10.7/10.8/10.9)
- Remote desktop control from AirPad, Touch Screen or Mouse/Keyboard for Windows/Mac
- Plug&Show: launching the projection application from a USB Token without installation. Extra USB tokens with the PlugandShow function can be easily created in the wePresent software.
- High performance 4-to-1 Quadrant Screen Projection
- Support up to 64 concurrent login users
- Conference Control: Mediator function through the device web page or standby screen
- Support Wireless Multi-touch control (Win7/8 standard HID compatible device)

- Support drawing feature for projecting sender screen, or drawing on whiteboard without PC
- Changeable Customized Image of full size Splash/standby screen.
 - Replace entire start screen with background image. SNMP V3: manage/configure multiple WiPGs through SNMP V3 protocol
 - Firmware upgrade via FTP
 - Enhance the remote SNMP manageability to higher security level
- Wi-Fi Enterprise encryption support
- Support MSI installer for Windows software deployment and execute application from command line
- Extended desktop support for both Windows and Mac
- Security design: Session Login Code, WEP/WPA/WPA-Enterprise WiFi Security, and GateKeeper
- HDMI and VGA dual video interfaces
- WiFi AP, Station and AP-Client mode: Make WiPG-2000 a part of your wired or wireless network. Allowing internet access to all connected users and presentation from network computers.
- WiFi 802.11b/g/n

2 Package Contents

- wePresent WiPG-2000 Box
- wePresent WiPG-2000 USB Token
- AirPad device
- Power Adapter (DC +5V, 2.6A)
- 2 WiFi Antenna
- Quick Installation Guide
- Wall Mount Kit
- Warranty Card

3 USB Token Contents

- Windows Installer (WiPG-2000 Windows Installer)
- MAC Installer (WiPG-2000 Mac Installer)
- VAC Driver (For Windows XP Audio Projection)
- VDD Driver (For Windows XP/Vista Virtual Extended Screen)
- User Manual
- wePresent WiPG Execution File
- SVS Driver (For Mac Extended Screen)
- Utility
 - PtG Converter (For MobiShow PtG function)
 - SNMP Manager (For SNMP Management)

4 Physical Details

- **Front Panel**

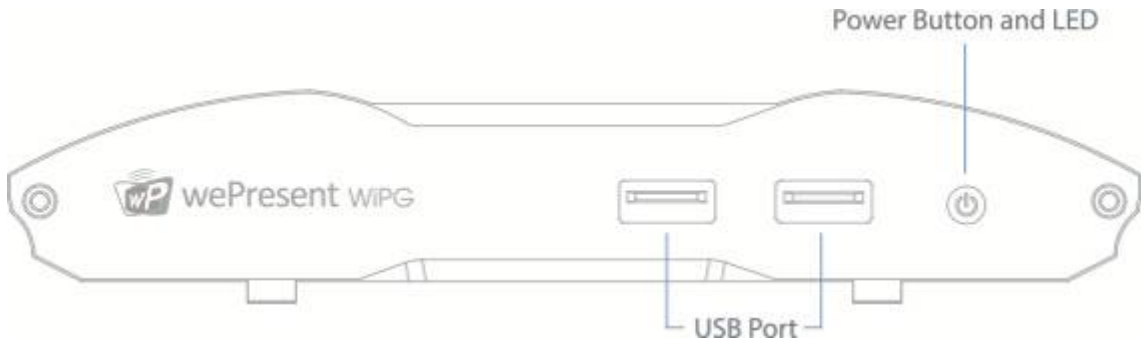

	Description
Power Button and LED	Power on/off button. LED Indicator: System Loading(Red), Ready(Blue)
USB Port (Front)	2 USB ports for USB mouse and keyboard

- **Rear Panel**

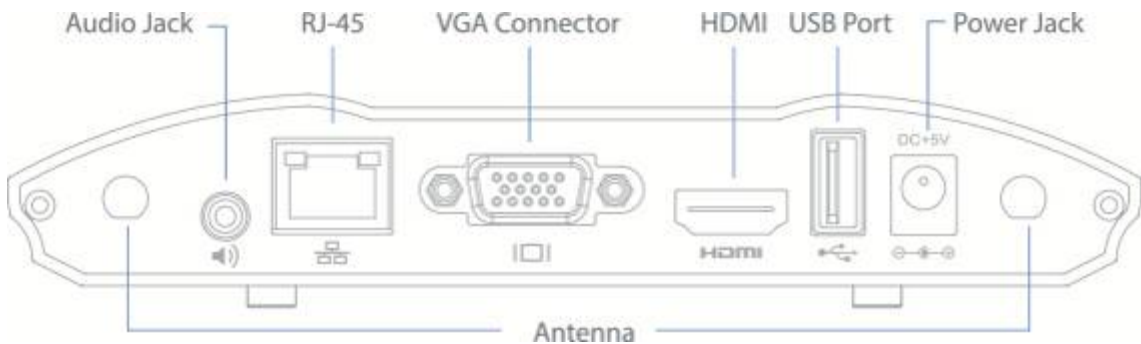

	Description
Antenna	WiFi Antenna
USB Port (Rear)	USB port for USB Thumb drive or Touch Device
RJ-45	10/100/1000M RJ-45 port
VGA Connector	VGA connector
HDMI	HDMI Connector
Audio Jack	Audio Jack (3.5mm)
Power Jack	Power Jack (5V/2.5A)

The USB port can support up to 5V/0.5A touch device and USB drive.

- **Bottom Side**

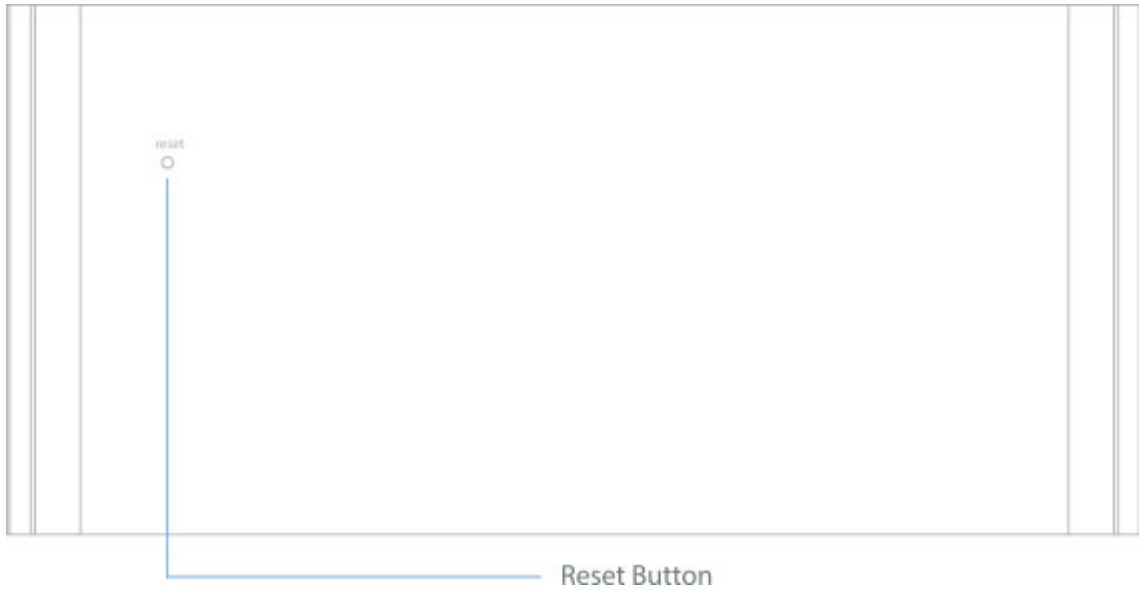

	Description
Screw Hole	Screw Hole for Wall Mount Kit
Reset Button	Press reset button and power on the device to execute Hardware Reset.

5 What You Might Need

- Projector/display with VGA/HDMI interface
- Windows or Mac PC/Laptop
- Apple iPhone, iPad or iPod-touch device
- Android Phone or Tablet device
- Speaker (Optional, for audio projection feature)
- USB Mouse and Keyboard (Optional, for remote desktop feature)
- USB HID Touch Screen/IWB Device (Optional, for UMT feature)

6 Quick Installation

- 1) Connect wePresent WiPG-2000 device to Projector/display through VGA/HDMI port and turn on projector/display power.

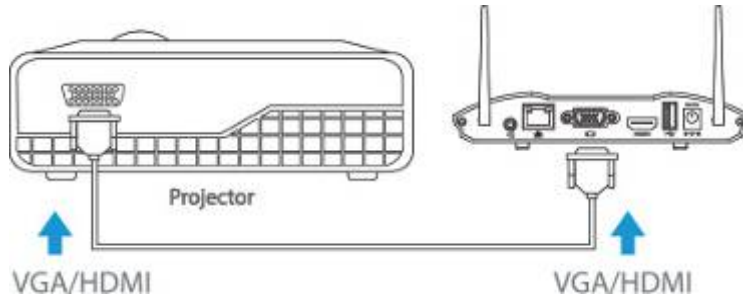

- 2) Connect the power adaptor to WiPG-2000 device and press the power button to turn on WiPG-2000 device. System will be ready when the LED light turns to blue.
 - It will show the default standby screen as below when system is ready.



- 3) Insert the speaker cable to WiPG-2000 audio jack for audio output
- 4) Insert the USB mouse or keyboard/AirPad or USB touch device to WiPG-2000 front/rear USB port for On-Screen Display (OSD) control. (Optional)

7 WiPG-2000 Start/Standby Page

7.1 Quick Guide / User-List

The device will show the quick guide on the screen when there is no user connected. When there is any new user connected to WiPG-2000, the user name will be show on the user-list area. WiPG-2000 allows multiple user connection. See below image for detail.



7.2 Feature Icons

1) You can also click on the feature Icons on the right hand bottom to view the Quick Guide for each highlight feature.

(1)**Quick Guide:** Click on Quick icon , it describes that WiPG-2000 can support Windows, Mac and Mobile devices. If your Smartphone has QR code scan App, you can scan the QR code image on the screen with your Smartphone which will lead you to the corresponding place to download all the available Apps.



(2) **WiFi-Doc(TBD)**: Click on WiFi-Doc icon , it describes the wireless presentation for Mobile using WiFi-Doc. If your Smartphone has QR code scan App, you can scan the QR code image on the screen with your Smartphone which will lead you to the corresponding place to download all the available Apps.



(3) **SidePad**: Click on SidePad icon , it describes WiPG-2000 support SidePad feature which allow users control the projecting screen on PC or Mac via iPhone/iPad or Android devices. If your Smartphone has QR code scan App, you can scan the QR code image on the screen with your Smartphone which will lead you to the corresponding place to download all the available Apps.



(4) **WebSlides**: Click on WebSlides icon . It describes WiPG-2000 support WebSlides feature which can broadcast slides to audience's web browser through network.



(5) **UMT**: Click on UMT icon . It describes WiPG-2000's UMT(Universal Multi-Touch) feature which can support standard touch device without installing driver.



(6) **Setup:** click on Setup icon , you can find the Firmware (FW) version, resolution, WiFi channel and AP-client status information on the screen. Meanwhile, you can also click on the “Calibration” function to calibrate the projecting screen to an optimization mode.



7.3 Remote Touch Control (UMT)

WiPG-2000 can support standard Win7/8 compatible HID touch device. By connecting the HID touch screen/IWB device, users can control the standby screen, direct draw and the projecting screen remotely from the Touch Screen/IWB device.

Note:



1. The UMT can only support standard USB HID touch device, it can't support the touch device required installing additional driver.
2. It will process the touch event and send the mouse event to sender when the sender is Windows XP, 7 and Mac.
3. The USB port on WiPG-2000 can supply up to 5V/0.5A power, the additional power supply is required if the attached HID device required more power.

7.4 Conference Control Mode

- 1) Click  to enable conference control mode and the sender will be blocked when they try to overtake the screen from the sender application. The moderator can only manage the projecting sender through web conference control page or the OSD PC-List.

- 2) Click  to disable conference control mode, the sender can overtake the screen freely by pressing the button on the sender application

7.5 Split Screen mode

- 1) Click on the “Split Screen”  button on the start page to enter “Split Screen” page. You can see the connected sender list and press the “add”  icon to choose them to the selected quadrant area.

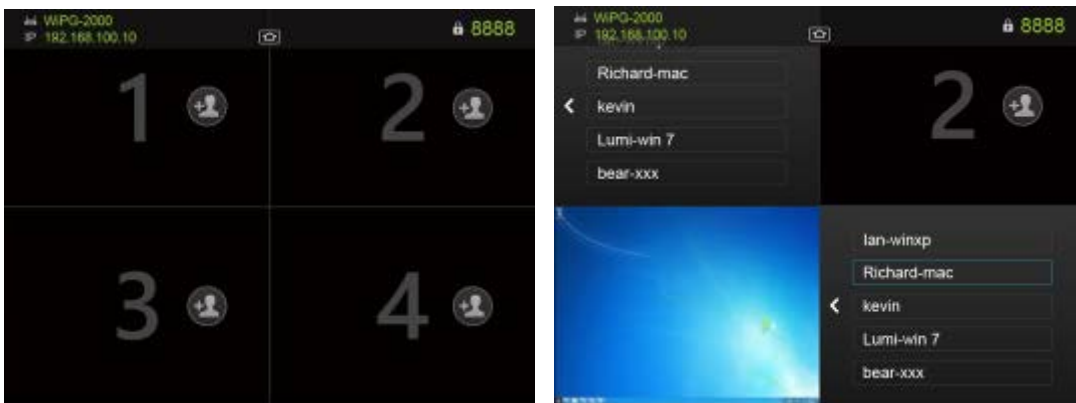





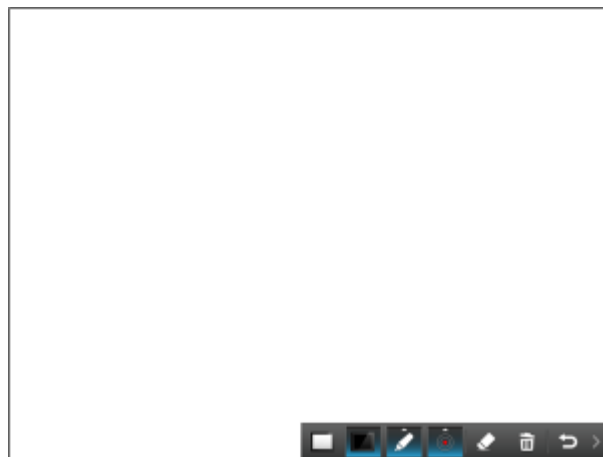



7.6 Direct Draw

- 1) Click on the “direct draw”  button on the start page to enter “direct draw” function page. You can make the free drawing on device screen through Mouse, AirPad, Touch Screen or IWB device.



Click on the “direct draw”  icon, the menu will pop up as below image.









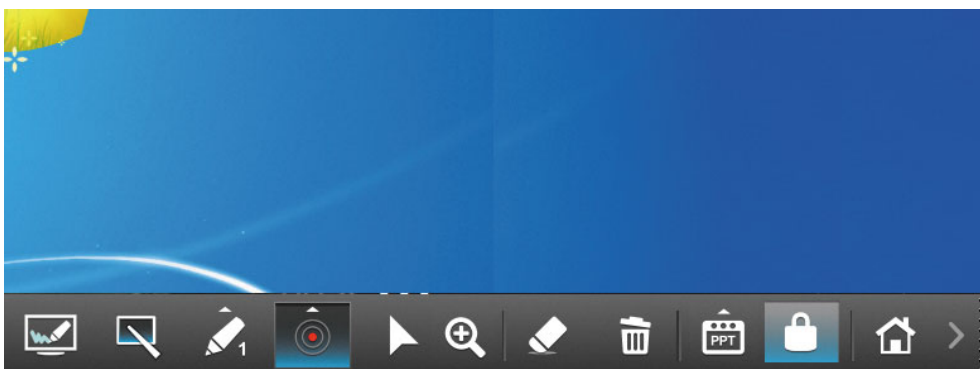



Pen Menu Function

Button	Description
	Open/Minimize all Pen menu bar.
	Home, Go back to wePresent home standby screen.
	Clear all of the drawing/writing on the screen.
	Erase part of drawing/writing.
	Select the pen color. (Red, Green, Blue)
	Select the size of the pen. (Small, Medium, Big)
	Click to use the blackboard. (All the drawing/writing will be cleared when changes to different mode)
	Click to use the whiteboard. (All the drawing/writing will be cleared when changes to different mode)

7.7 Pen Menu Function Under Projecting Mode.

- 1) When users are projecting through Windows, Mac, Android and iOS application, any Win7/8 standard HID compatible device (i.e AirPad/Mouse/IWB/Touch Screen) can be used for Pen feature. Users can do free drawings/writings and annotation on the projecting screen.



Item	Description
	Home, Go back to wePresent home standby screen.
	Enable/Disable the conference control mode.
  	<p>The tool for PowerPoint presentation.</p> <p>PageUp/PageDn, this button to go to previous/next page.</p> <p>SlideShow, When the user is projecting a PPT file, press this button to enable Slide Show function.</p> <p>ESC, When the user is projecting a PPT file, press this button to quit Slide Show mode.</p>
	Clear all of the drawing/writing on the screen.
	Erase part of drawing/writing.
	Enable the magnifier function.
	Change to Mouse mode for remote control function.
	Select the color and size for Pen mode. (Red, Green, Blue)
	Select the size of the pen. (Small, Medium, Big)
	Change to Pen mode for drawing/writing function.
	Change to Pointer Mode.

7.8 USB Player function

- 1) Click on the “USB Player”  button on the start page to enter “USB Player” function. You can playback the Photo/Music/Video/Office files from the attached USB drive. Details please see the USB Player section.

8 DoWiFi for Windows

(Do Not Support Windows Phone, Windows RT)

8.1 Install the application

- 1) Make sure your PC WiFi is enabled already, and connect your PC to wePresent WiPG-2000 box through WiFi. You can find the WiFi name of your WiPG box information on the start/standby page.

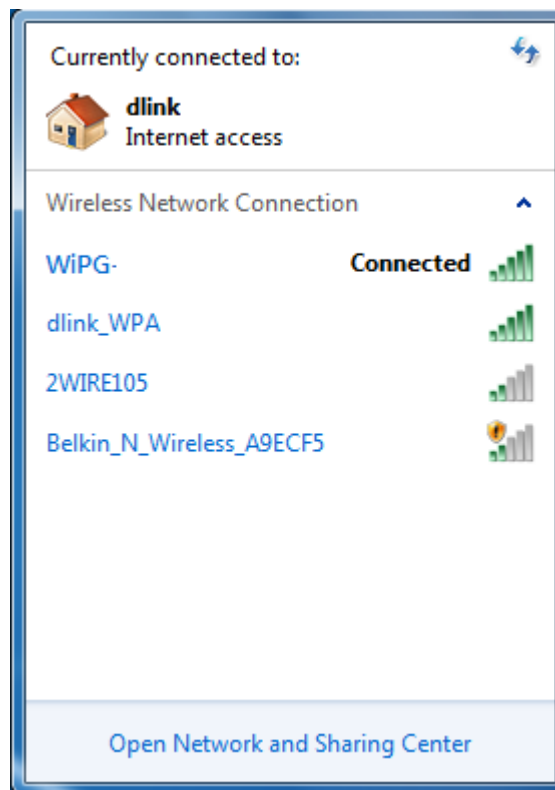

- 2) Launch your browser and enter the Device Host Name (SSID) or IP address in the browser. You can find the IP address and Host Name (SSID) on the projector/display screen. **(Default Host Name (SSID) is WiPG-2000-xxx, Default IP is 192.168.100.10)**
- 3) Download the wePresent software for “XP/Vista/Windows 7 / 8” and install on your PC. (Ps. You can also launch the application from USB token directly.)



- 4) When the download is completed, follow the wePresent WiPG Setup wizard to execute the software.
(Make sure your WiFi have connected to WiPG-2000-xxx and your PC's personal firewall allows wePresent WiPG-2000 software to pass through.)

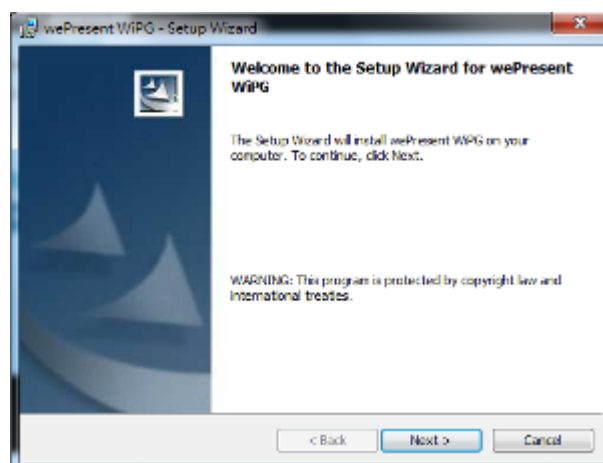

8.2 Start the application



- 1) Click wePresent WiPG-2000 icon on desktop to execute the application, or launch the application from USB token directly. (You can find the wePresent WiPG-2000.exe under wePresent WiPG folder).
- 2) It will start to search wePresent WiPG-2000 receiver automatically.

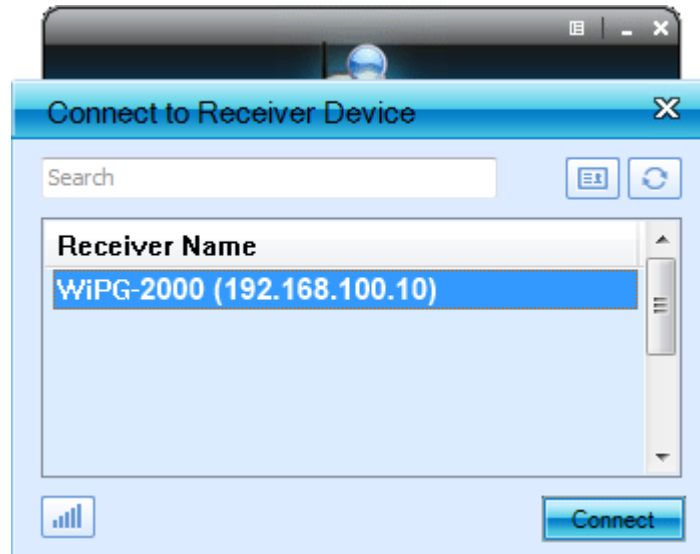

8.3 Recent Connection

- 1) WiPG-2000 will memorize the successful connection profiles and open the recent connect dialog, you can select one of the profile and press the "Connect" button to connect this WiPG-2000 directly.

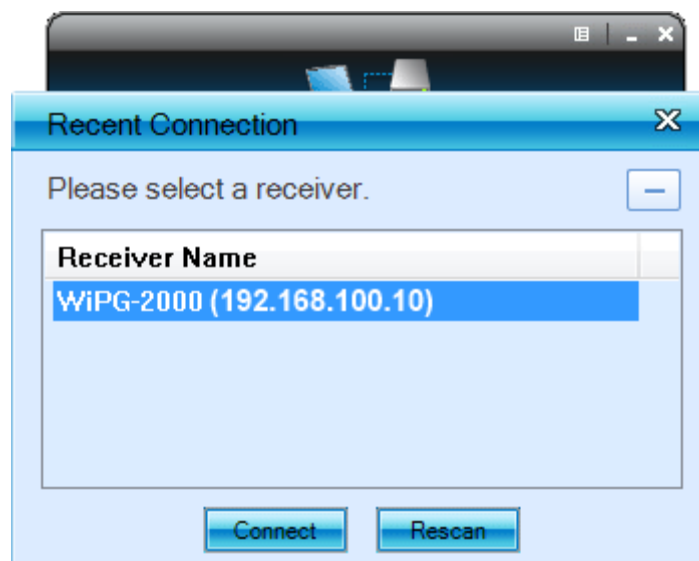

- 2) If you want to connect to another WiPG-2000 receiver, please press the “Rescan” button.

8.4 Connect to Receiver Device

- 1) WiPG-2000 application will search and list the WiPG-2000 receiver Device. You can select the target receiver device and press “Connect” button to connect the selected receiver device.

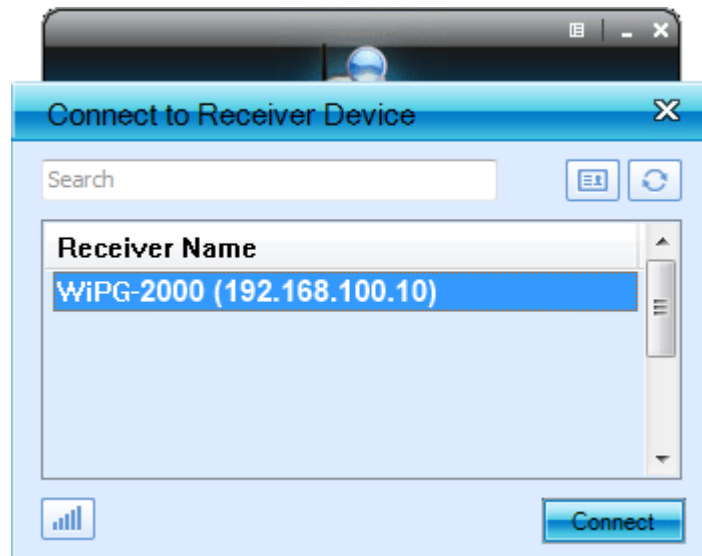

- 2) You can press the “Refresh” button to search again.
- 3) If you can't find the target receiver device from the list, you can press the “Manual” button to enter the receiver IP address manually and connect.
- 4) If you want to change to another WiFi network, you can press the “WiFi” button to list the available WiFi network.

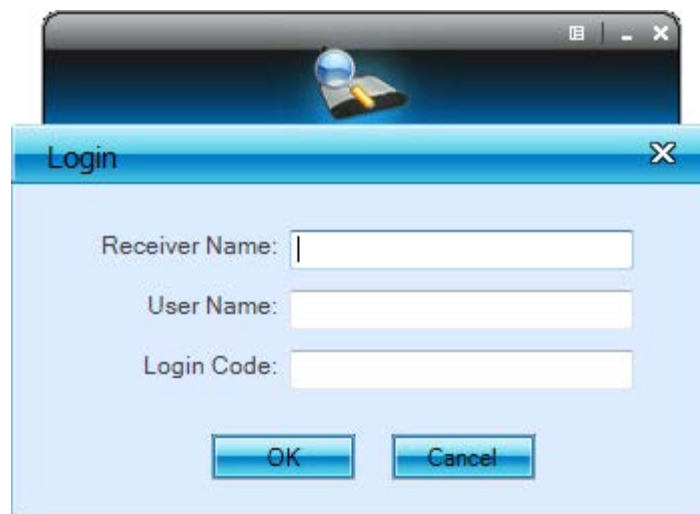

8.5 Login

- 1) When connecting to a “Code” protection enabled WiPG-2000 receiver, you have to enter the “Code” and press the “Connect” button to login the receiver.
(You can find the CODE from the OSD standby screen or right-upper corner of start screen)



(Enter the code into the circled area)

- 2) If you want to connect to another receiver or cancel the login, please press the “Cancel” button.

8.6 Change to another WiFi Network

- 1) If you press the “WiFi” icon, WiPG-2000 application will search the available WiFi Network and list the WiPG-2000 WiFi Device. You can select a network and press the “Connect” button to connect the selected WiFi Device.

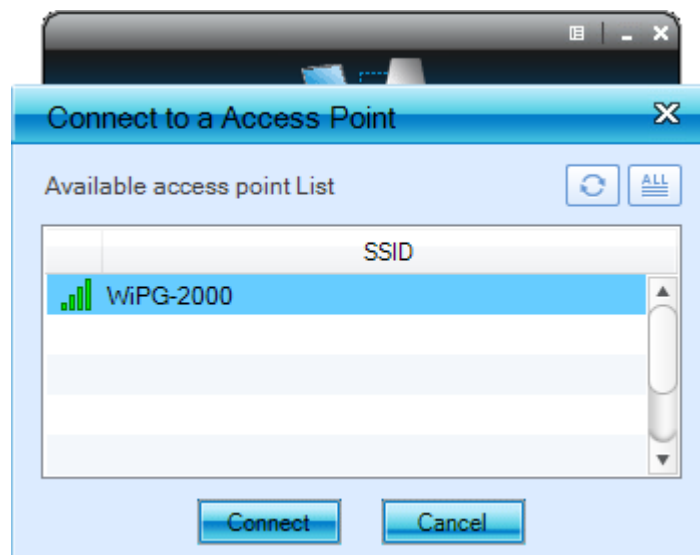













- 2) You can press the “Refresh” button to search again or press the “All” button to list all available WiFi Network name.
- 3) If you don’t like to change the WiFi Network and want to keep the connection to current network, you can press the “Cancel” button.

8.7 Main User Interface



8.8 Screen Projection

- 1) Click the "Play" button for full or "1,2,3,4" for split screen projection, you can project the main screen on to the display immediately. Click the "Pause" button, you can freeze you projection screen, and click the "Stop" button to stop projecting your screen.

Button	Description	Button	Description
	Presentation Function Tab		Video Function Tab
	Full Screen projection (Support audio projection)		Project to Split #1 (Support audio projection)
	Project to Split #2 (No audio projection)		Project to Split #3(No audio projection)
	Project to Split #4(No audio projection)		Stop projecting
	Pause projecting		Magnifier function
	Mute/Unmute for screen projection		Open/Hide Connected Receiver List

Note:



1. Audio Function:

For Windows XP system, if you can't hear the audio, please install the Audio driver ("VAC.exe", Virtual Audio Control Driver) on your computer first, you can find the software from USB Token.

(Windows Vista, Win7 and Win8 is not necessary to install VAC driver)

8.9 Connected Receiver list

Press on the "arrow" button to expand the connected receiver list, and press the "add" button to add another receiver. During standby status, you can press the "check" button to select the multiple receivers (up to 4) to mirror your screen, and press "radio" button to select one of the receiver to send the audio.

Button	Description
	Add another receiver
	Select the receiver to project your screen and stream the video. (up to 4)
	Select the receiver to send audio (One of them)

8.10 Video Streaming

Click the "Open File" button to select the video/music files for the streaming. Click the "Pause" or "Stop" button, you can pause or stop the streaming, and click the "Volume" button to mute, adjust the volume level.



Button	Description
	Play the video/Music
	Stop the Video/Music
	Open the Video/Music File
	Mute/Unmute
	Repeat On/Off

Note:

Item	Value
Supported File Format	MPEG-1 / MPEG-2 / MPEG-2 TS / MPEG-4 / WMV9 / MOV / Motion JPEG / MKV / ASF / DVR-M5
Supported Video Codec	MPEG-1 / MPEG-2 / MPEG-2 TS / MPEG-4* / WMV9** / QuickTime / Motion JPEG * Microsoft MPEG-4 v1-3 is not supported. ** Only WMV3/WVC1 is supported.
Supported Audio Codec	LPCM / AAC / MP3 / WMA

* All formats support up to 1920x1080, 30fps, and 20Mbps.

* These file formats might include video and audio codecs which are not supported.

8.11 Menu

- 1) Press “Menu” button from the main UI, you will find the menu to enable the additional feature or to change the application options.

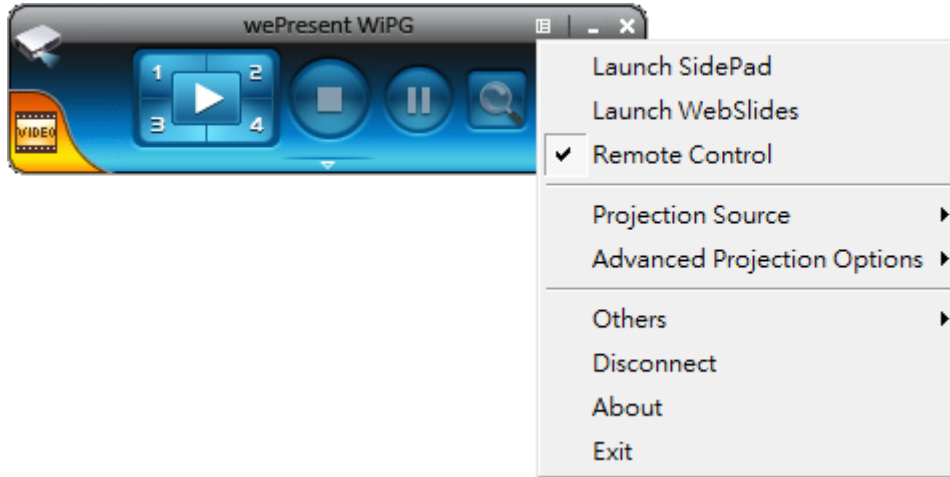

8.11.1 Launch SidePad

Introduction: SidePad is an application to allow the user to connect Pad/Smartphone (Android and iOS), PC, and display/projector via WiPG-2000 device. User can then control the projecting PC via Pad/Smartphone. Please refer to the below image for more information.



- 1) SidePad Control for Android/iOS device.
 - Android: Download “SidePad Receiver” from Google Play Store
 - iOS: Download “SidePad Receiver” from Apple Store.
 - Connect your Android device to WiPG-2000 device through WiFi and Launch “SidePad Receiver”



- Click on “Launch SidePad” from the menu. In seconds, you shall see the PC desktop shown on the iOS/Android Device. Now you can control the projecting PC from your iOS/Android device.



- 2) If there is no Smartphone/Pad device detected after clicking on “Launch SidePad” the below image will show up.

The image shows a dialog box titled "SidePad: Login". It contains two input fields: "Device IP:" with the value "192.168.168.143" and "User Name:" with the value "PCHOU". Below the input fields are two buttons: "Connect" and "Cancel".

8.11.2 Launch WebSlides

- 1) Introduction: Webslides is an application to allow the user/presenter to broadcast the projecting screen/slides to allow multiple login users to receive the slides during a presentation and save the slides for note taking later.



- 2) Presenter: Make sure your PC/Mac is connected to WiPG-2000 box and click on “Launch Webslides”, when the function is on, the item will be checked on the main menu.
- 3) Audience: Users need to connect to WiPG-2000 WiFi Network as the presenter and then launch their browser and enter WiPG-2000 IP address (The information can be found on the projecting screen) on the URL of browser. Once the users are connected, they will see the below image on their devices. Click on “Webslides” button. See below:

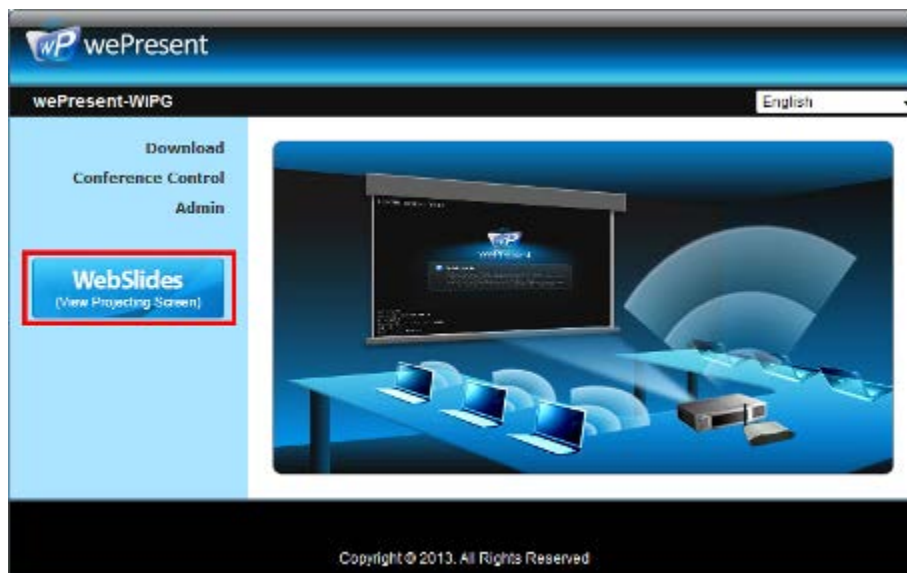

- 4) Start to receive the presenter’s slides (Auto refresh every 30 sec). The below image can be seen on the audience’s browser.



Users can put the mouse/finger on each button to get the “tip window” for the function of each button.

Note:

The WiPG-2000 logged-in user is not identical to WebSlides user, and they both consume the wireless bandwidth for device connection. If there are more than 10 users logged into WiPG-2000, it is recommended to connect WiPG-2000 to company network through Ethernet or bridge WiPG-2000 to a router due to wireless bandwidth concern. User should connect WiPG-2000 via company network or router in order to secure the projection performance. The WebSlides user number should not exceed the recommended number on the web management page to prevent the connection failure or low projection performance.

PS. Wireless Projection function and Conference Control function can support up to 64 users.

8.11.3 Remote Control

- 1) Click on “Remote Control”, you can allow or block the remote mouse/keyboard/touch control from WiPG-2000 receiver.

8.11.4 Projection Source

- 1) Click on “Select Projection Desktop”, you can select to project the main screen or the extended screen.



Note:

1. For Windows XP system, you need to install “VDD.exe” driver first, you can find it from USB token.
2. For Windows 7/Vista Starter edition, it can’t support extended screen.
3. For some Win7/Win8 laptop/tablet, the extended screen feature is not supported if the display card can’t support the extended screen function. This typically can be verified by checking whether it can enable the extended screen through physical VGA cable, if yes, then it should work with wePresent software.

8.11.5 Advanced Projection Option

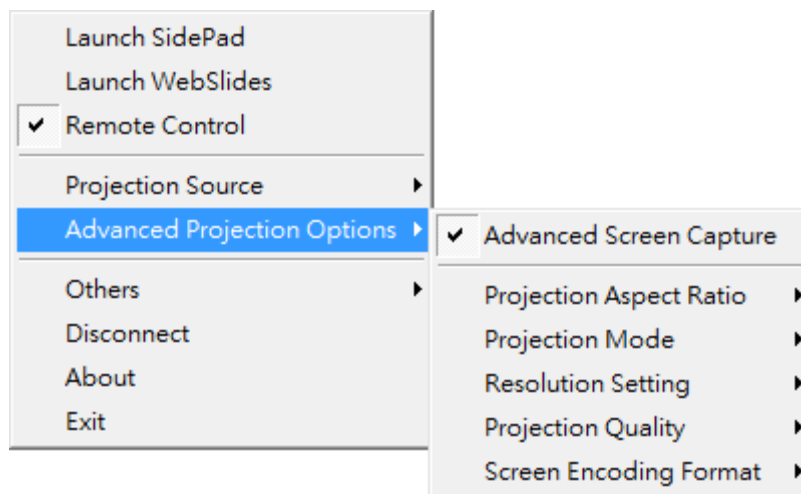

8.11.5.1 Advanced Screen Capture

- 1) Click on “Advanced Screen Capture”, you will be able to see tip windows and other layered windows (include the main UI) on the connected display. However, the mouse cursor may blink from time to time when you are projecting your PC screen!
- Disable “Advanced Screen Capture”.



- Enable “Advanced Screen Capture”.

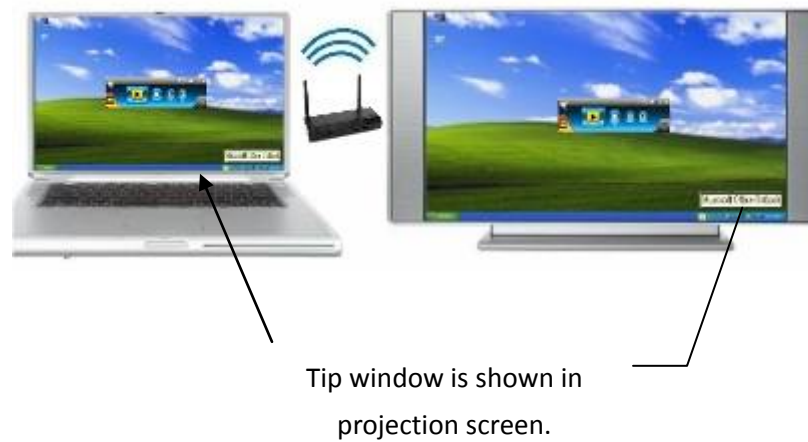

8.11.5.2 Projection Aspect Ratio

- 1) Click on “Projection Aspect Ratio”, choose “Keep aspect ratio” to keep the original aspect ratio if the desktop resolution is different from WiPG-2000 output resolution, or choose “Fit full screen” to project the screen to full screen.

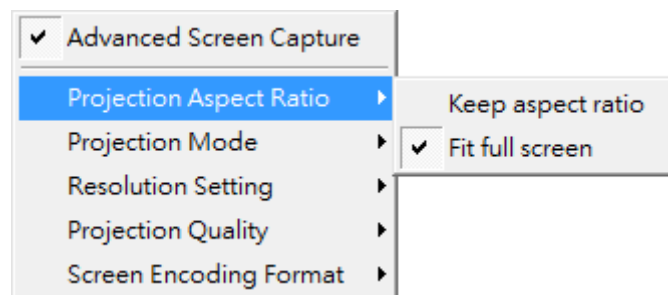

8.11.5.3 Select Projection Mode

- 1) Click on “Select Projection Mode”, choose the Presentation mode for shortest latency or the Video mode for auto-latency control to have better video

performance.

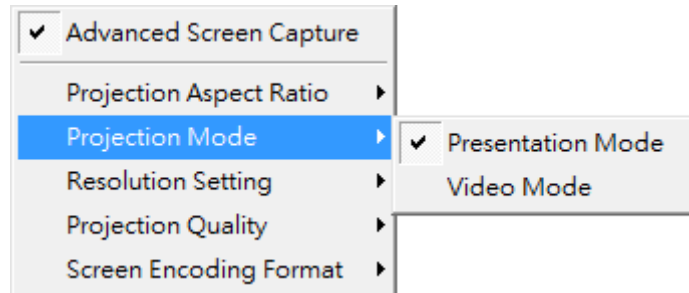

8.11.5.4 Resolution Settings

- 1) Click on "Resolution Setting", choose "Never Change" to keep original desktop resolution, "Always Change" to change resolution automatically according to application's recommendation, or "Always ask me" to prompt a resolution change message to user.

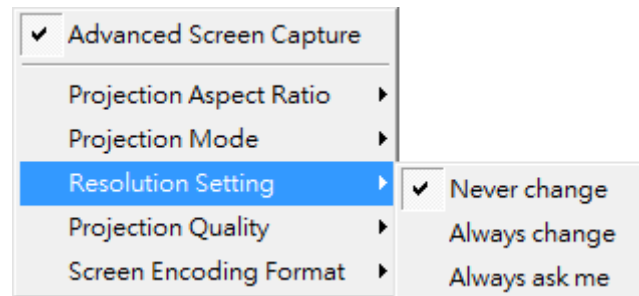

8.11.5.5 Projection Quality

- 1) Click on "Projection Quality", choose "Normal" for faster projection speed with lower screen image quality, and "Best" for clear screen image quality but slower projection speed.

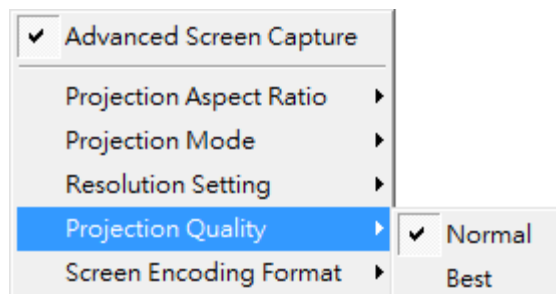

8.11.5.6 Screen Encoding Format

- 1) Click on "Screen Encoding Format", choose "JPG" for better image quality but

bigger network bandwidth required, and “H264” for smaller data size with reasonable image quality, and “Auto” that the application will select the encoding type automatically according to the receiver’s and sender’s setting and status.

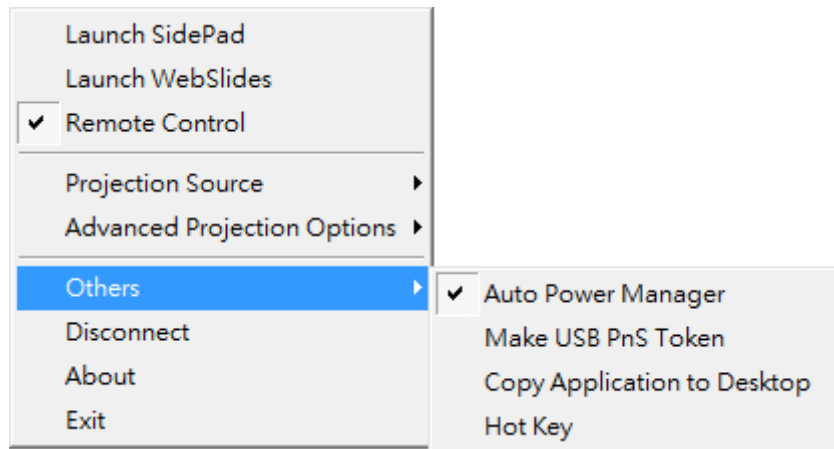

8.11.6 Others

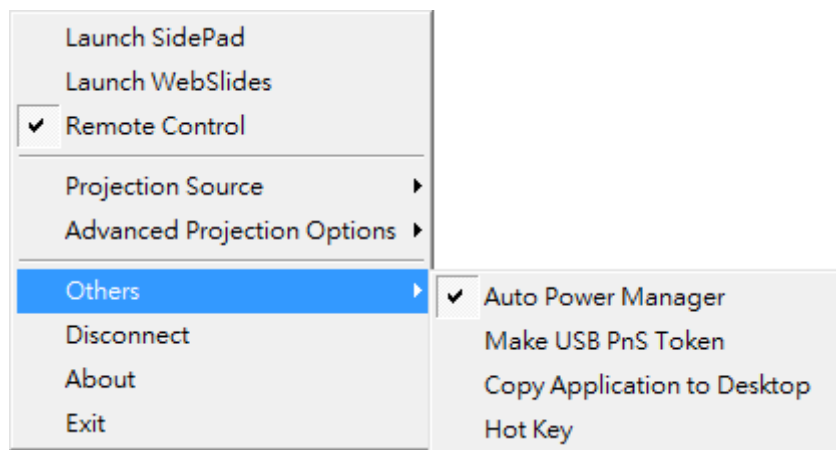

8.11.6.1 Auto Power Manager

- 1) To make the highest projection performance, application will turn the PC's windows power scheme from current settings to “highest performance”, however, you can click on “Auto Power Manage” to enable or disable this function and restore you power scheme immediately.



8.11.6.2 Make USB PnS Token

- 1) Click “Make USB PnS Token” to make a USB wePresent WiPG-2000 Token, you can insert a USB and follows the wizard to make the Token. After completion, you can plug the USB to any PC to do the projection without installing the wePresent WiPG software onto every PC.

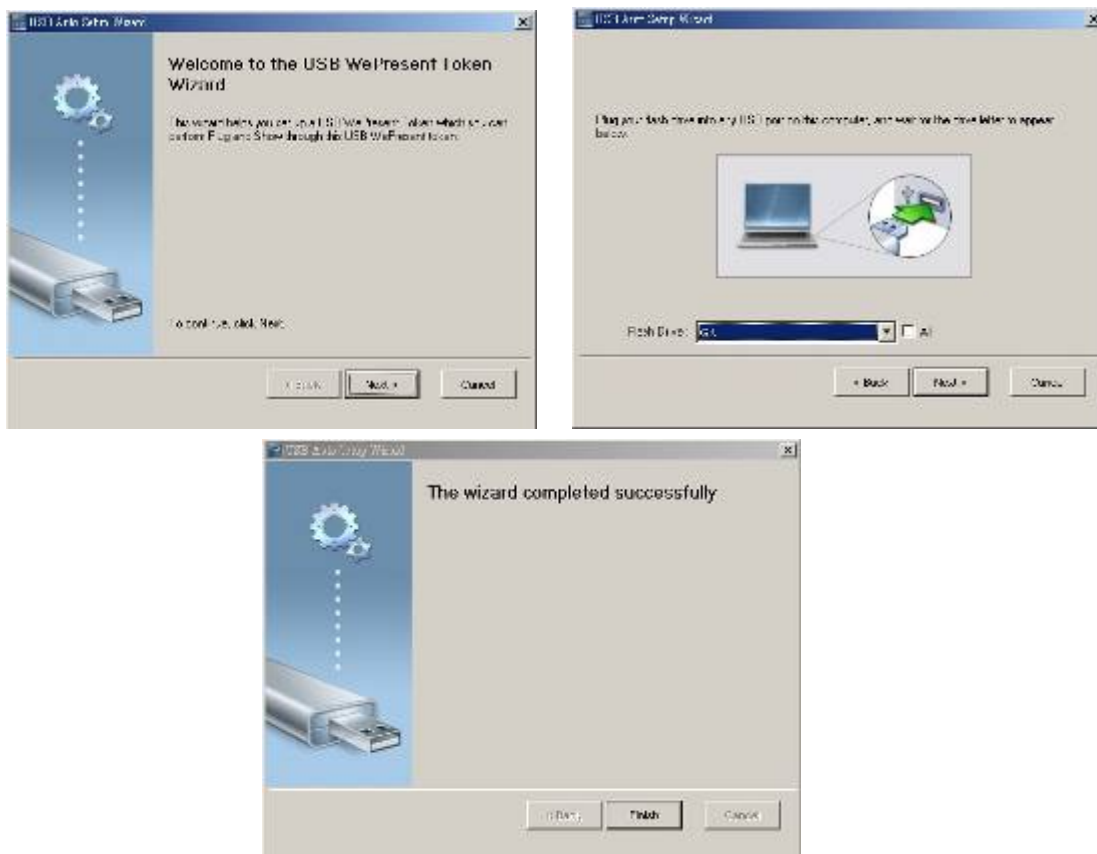

8.11.6.3 Copy Application to desktop

- 1) Click on “Copy Application to desktop”, it will copy the application to your desktop immediately.

8.11.6.4 Hot Key

- 1) Click on “Hot Key” to display the available Hot Key definition.

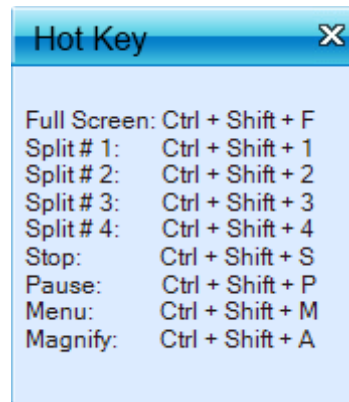

8.11.7 Disconnect

- 1) Click on “Disconnect” to disconnect from current connected receivers.

8.11.8 About

- 1) Click on “About” to show system information. It includes product model name, Application version.

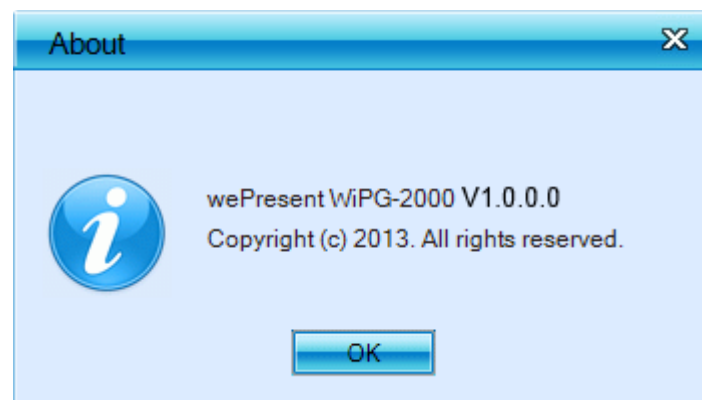

8.11.9 Exit

- 1) Click on “Exit” to exit this application. It will stop current playing status and shut down the application immediately.

9 DoWiFi for Mac

9.1 Install the application

- 1) Make sure your PC WiFi is enabled and connect your PC to wePresent WiPG-2000 box through WiFi.
- 2) Launch your browser and enter the IP address on browser. You can find the IP address and Host Name (SSID) on the projector/display screen. **(Default IP is 192.168.100.10)**
- 3) Download the wePresent software for “Mac” and install on your PC.

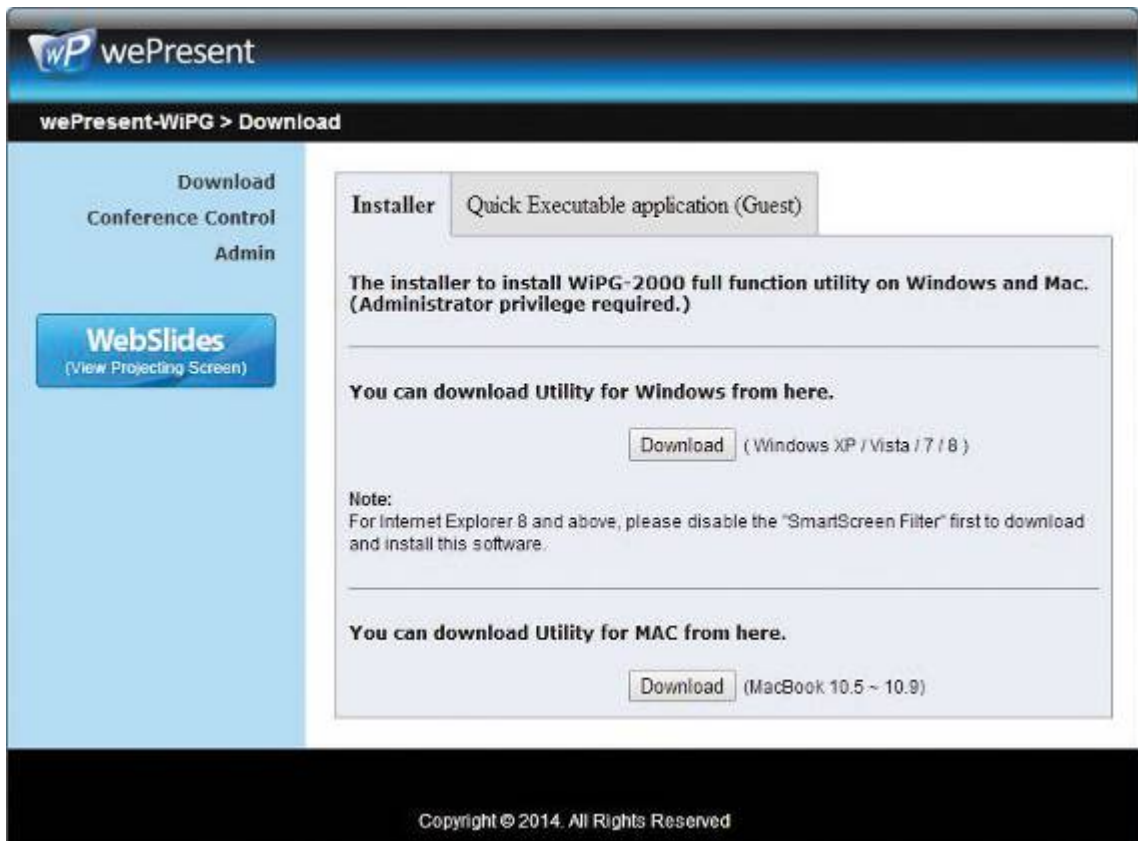

- 4) When the download is completed, follow the wePresent WiPG Setup wizard to execute the software.

9.2 Start the application

- 1) Click on wePresent WiPG-2000 icon from Application folder to execute the application.
- 2) It will start to search wePresent WiPG-2000 receiver automatically.

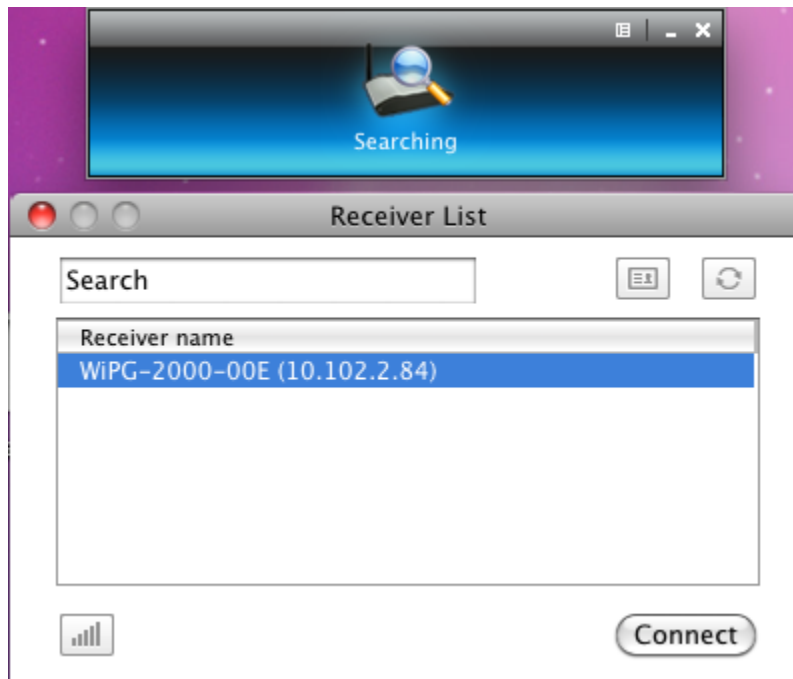

9.3 Recent Connection

- 1) WiPG-2000 will memorize the successful connection profiles and open the recent connect dialog, you can select one of the profile and press the “Connect” button to connect this WiPG-2000 directly.

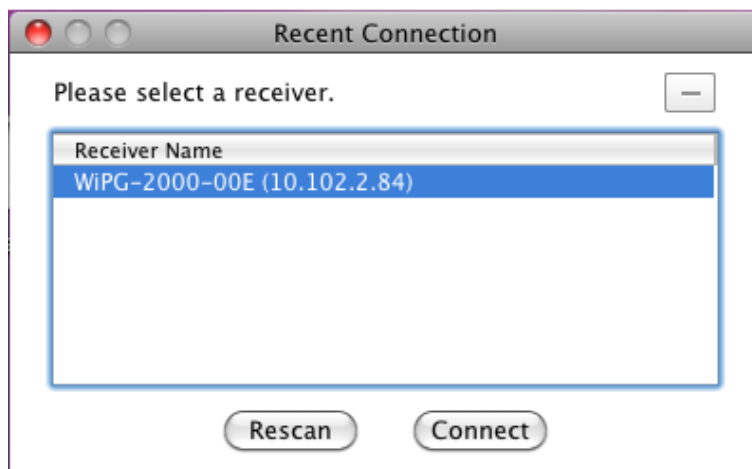

- 2) If you want to connect to another WiPG-2000 receiver, please press the “Rescan” button.
- 3) WiPG-2000 application will search and list the WiPG-2000 receiver Device. You can

select the target receiver device and press “Connect” button to connect the selected receiver device.

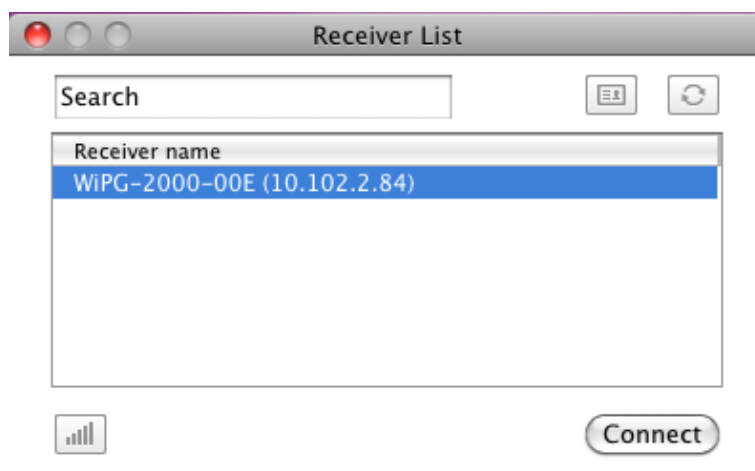

- 4) You can press the “Refresh” button to search again.
- 5) If you can’t find the target receiver device from the list, you can press the “Manual” button to enter the receiver IP address manually and connect.

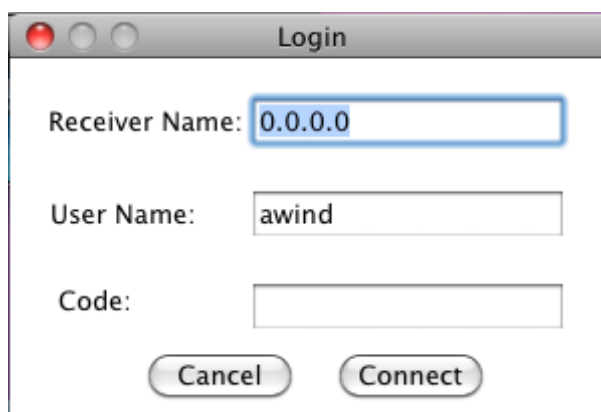

- 6) If you want to change to another WiFi network, you can press the “WiFi” button to list the available WiFi network.

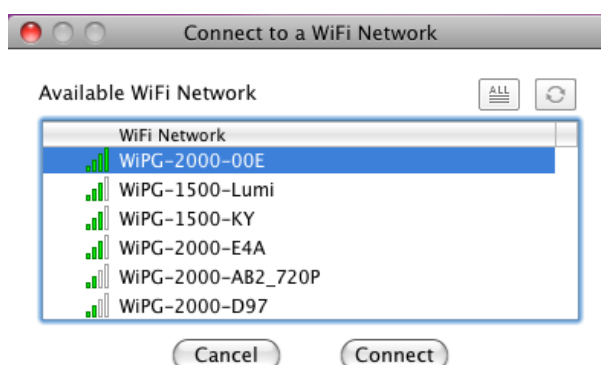

9.4 Login

- 1) When connecting to a “Code” protection enabled WiPG-2000 receiver, you have to enter the “Code” and press the “Connect” button to login the receiver.

(You can find the CODE from the OSD standby screen or right-upper corner of start screen)

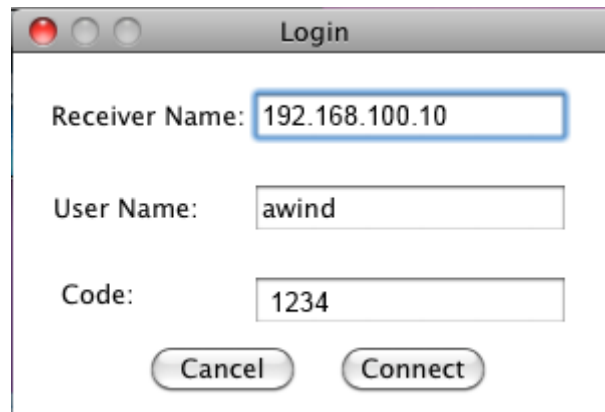

- 2) If you want to connect to another receiver or cancel the login, please press the "Cancel" button.

9.5 Change to another WiFi Network

- 1) If you press the "WiFi" icon, WiPG-2000 application will search the available WiFi Network and list the WiPG-2000 WiFi Device. You can select a network and press the "Connect" button to connect the selected WiFi Device.

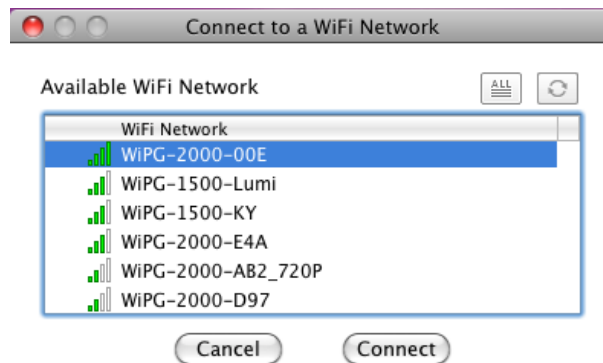





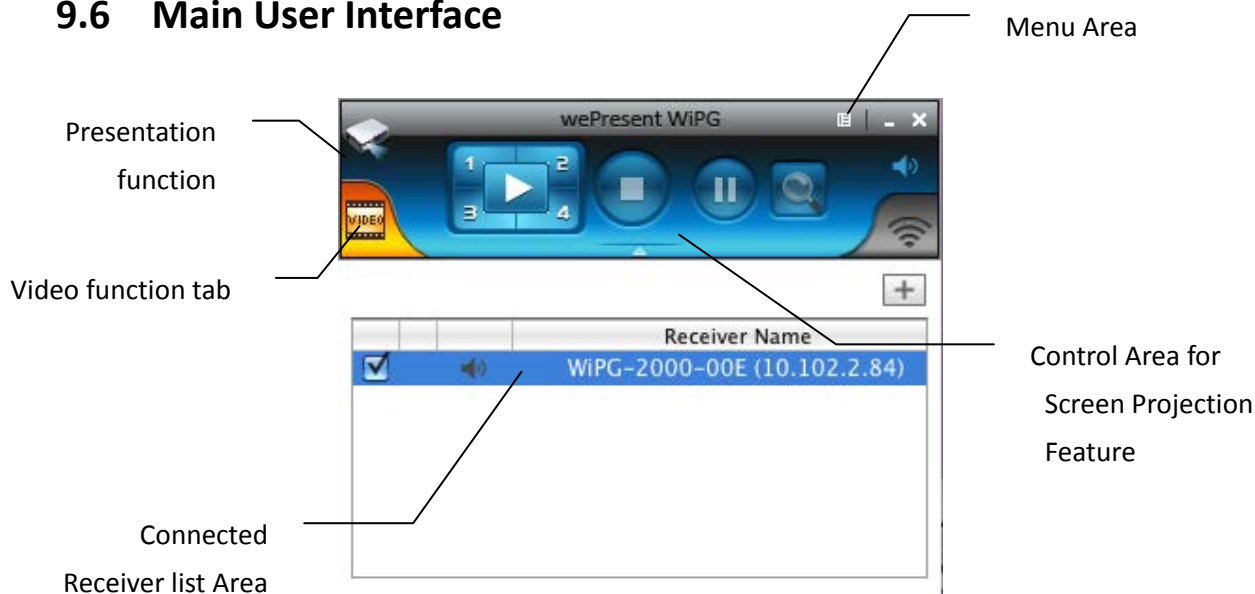







- 2) You can press the "Refresh" button to search again or press the "All" button to list all available WiFi Network name.
- 3) If you don't like to change the WiFi Network and want to keep the connection to current network, you can press the "Cancel" button.

9.6 Main User Interface



9.7 Screen Projection



- 1) Click the “Play” button for full or “1,2,3,4” for split screen projection, you can project the main screen on to the display immediately. Click the “Pause” button, you can freeze you projection screen, and click the “Stop” button to stop projecting your screen.

Button	Description	Button	Description
	Presentation Function Tab		Video Function Tab
	Full Screen projection (Support audio projection)		Project to Split #1 (Support audio projection)
	Project to Split #2 (No audio projection)		Project to Split #3(No audio projection)
	Project to Split #4(No audio projection)		Stop projecting
	Pause projecting		Magnifier function
	Mute/Unmute for screen projection		Open/Hide Connected Receiver List

Note: For audio feature, please install the SoundFlower on your computer first, you can find the software from USB Token.

9.8 Connected Receiver list



Press on the “arrow” button to expand the connected receiver list, and press the “add” button to add another receiver. During standby status, you can press the “check” button to select the multiple receivers (up to 4) to mirror your screen, and press “radio” button to select one of the receiver to send the audio.

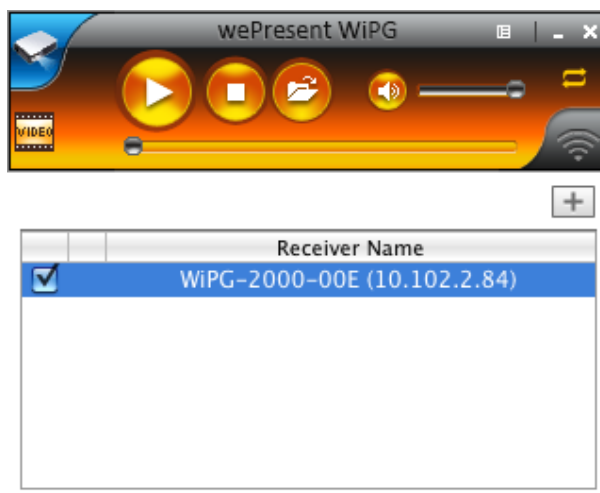

Button	Description
	Add another receiver.
	Select the receiver to project your screen and stream the video. (up to 4)
	Select the receiver to send audio. (One of them)

9.9 Video Streaming

Click the “Open File” button to select the video/music files for the streaming. Click the “Pause” or “Stop” button, you can pause or stop the streaming, and click the “Volume” button to mute, adjust the volume level.



Button	Description
	Play the video/Music.
	Stop the Video/Music.
	Open the Video/Music File.

	Mute/Unmute
	Repeat On/Off

Note:

Item	Value
Supported File Format	MPEG-1 / MPEG-2 / MPEG-2 TS / MPEG-4 / MWV9 / MOV / Motion JPEG / MKV / ASF / DVR-M5
Supported Video Codec	MPEG-1 / MPEG-2 / MPEG-2 TS / MPEG-4* / WMV9** / QuickTime / Motion JPEG * Microsoft MPEG-4 v1-3 is not supported. ** Only WMV3/WVC1 is supported.
Supported Audio Codec	LPCM / AAC / MP3 / WMA

* All formats support up to 1920x1080, 30fps, and 20Mbps.

* These file formats might include video and audio codecs which are not supported.

9.10 Menu

- 1) Press “Menu” button from the main UI, you will find the menu to enable the additional feature or to change the application options.

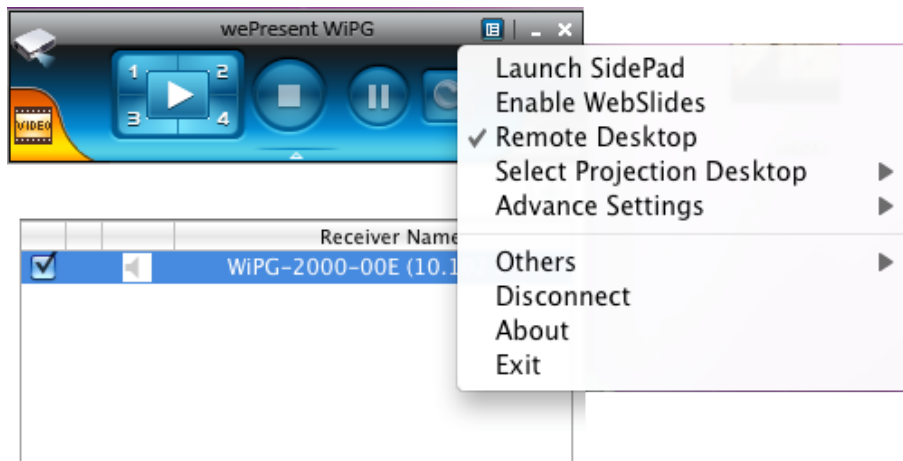

9.10.1 Launch SidePad

- 1) Introduction: SidePad is an application to allow the user to connect Pad/Smartphone (Android and iOS), PC, and display/projector via WiPG-2000 device. User can then control the projecting PC via Pad/Smartphone. Please refer

to the below image for more information.



2) SidePad Control for Android/iOS device.

- Android: Download “SidePad Receiver” from Google Play Store
- iOS: Download “SidePad Receiver” from Apple Store.
- Connect your Android device to WIPG-2000 device through WiFi and Launch “SidePad Receiver”



- Click on “Launch SidePad” from the menu. In seconds, you shall see the PC desktop shown on the iOS/Android Device. Now you can control the projecting PC from your iOS/Android device.



- ## 3) If there is no Smartphone/Pad device detected after clicking on “Launch SidePad” the below image will show up.

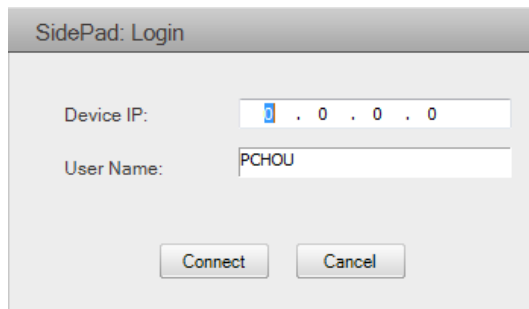

9.10.2 Launch WebSlides

- 1) Introduction: Weblides is an application to allow the user/presenter to broadcast the projecting screen/slides to allow multiple login users to receive the slides during a presentation and save the slides for note taking later.



- 2) Presenter: Make sure your PC/Mac is connected to WiPG-2000 box and click on “Launch Weblides”, when the function is on, the item will be checked on the main menu.
- 3) Audience: Users need to connect to WiPG-2000 WiFi Network as the presenter and then launch their browser and enter WiPG-2000 IP address (The information can be found on the projecting screen) on the URL of browser. Once the users are connected, they will see the below image on their devices. Click on “Weblides” button. See below:

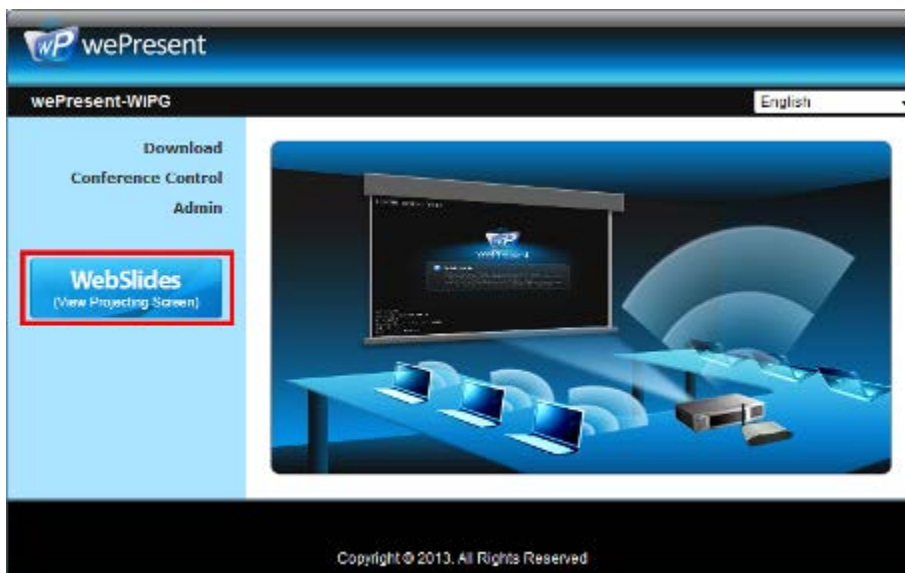

- 4) Start to receive the presenter's slides (Auto refresh every 30 sec). The below image can be seen on the audience's browser.



Users can put the mouse/finger on each button to get the “tip window” for the function of each button.

Note:

The WiPG-2000 logged-in user is not identical to WebSlides user, and they both consume the wireless bandwidth for device connection. If there are more than 10 users logged into WiPG-2000, it is recommended to connect WiPG-2000 to company network through Ethernet or bridge WiPG-2000 to a router due to wireless bandwidth concern. User should connect WiPG-2000 via company network or router in order to secure the projection performance. The WebSlides user number should not exceed the recommended number on the web management page to prevent the connection failure or low projection performance.

PS. Wireless Projection function and Conference Control function can support up to 64 users.

9.10.3 Remote Desktop

- 1) Click on “Remote Desktop”, you can allow or block the remote mouse/keyboard/touch control from WiPG-2000 receiver.

9.10.4 Select Projection Desktop

- 1) Click on “Select Projection Desktop”, you can select to project the main screen or the extended screen.

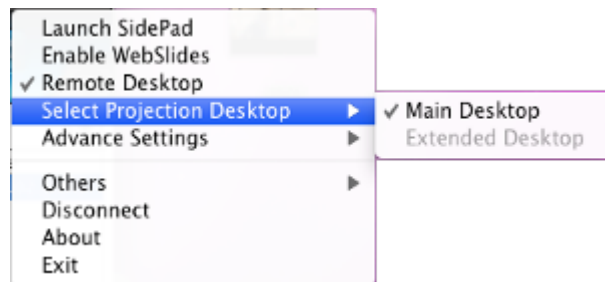

Note: It can only support Mac 10.7 and 10.8. To use the extended screen, you have to install the SVS extended screen driver which can be found from the USB Token.

9.10.5 Advanced Settings

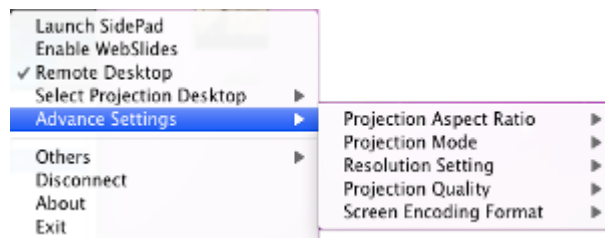

9.10.5.1 Projection Aspect Ratio

- 1) Click on “Projection Aspect Ratio”, choose “Keep aspect ratio” to keep the original aspect ratio if the desktop resolution is different from WiPG-2000 output resolution, or choose “Fit full screen” to project the screen to full screen.

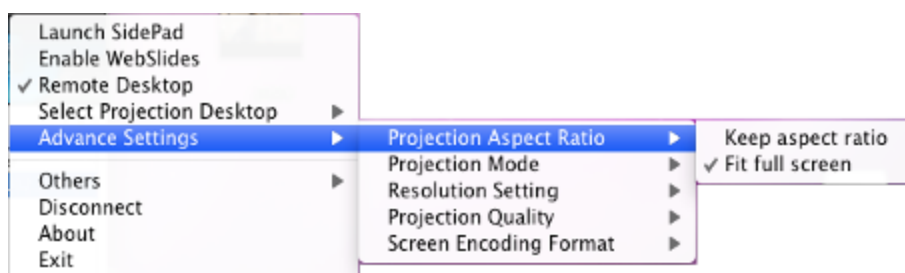

9.10.5.2 Select Projection Mode

- 1) Click on “Select Projection Mode”, choose the Presentation mode for shortest latency or the Video mode for auto-latency control to have better video performance.

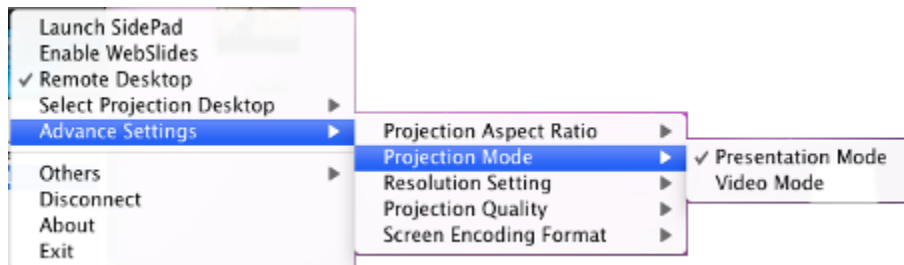

9.10.5.3 Resolution Settings

- 1) Click on “Resolution Setting”, choose “Never Change” to keep original desktop resolution, “Always Change” to change resolution automatically according to application’s recommendation, or “Always ask me” to prompt a resolution change message to user.

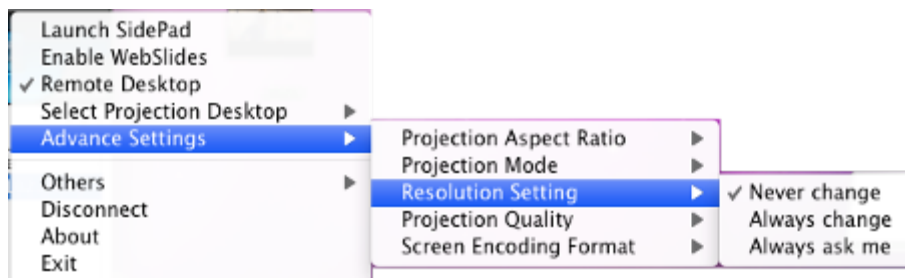

9.10.5.4 Projection Quality

- 1) Click on “Projection Quality”, choose “Normal” for faster projection speed with lower screen image quality, and “Best” for clear screen image quality but slower projection speed.

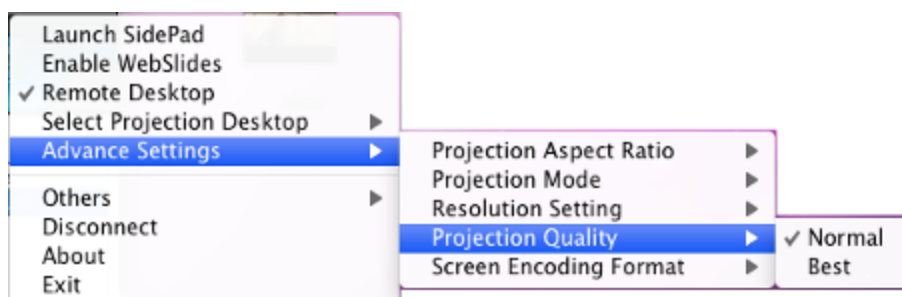

9.10.5.5 Screen Encoding Format

- 1) Click on “Screen Encoding Format”, choose “JPG” for better image quality but bigger network bandwidth required, and “H264” for smaller data size with reasonable image quality, and “Auto” that the application will select the encoding type automatically according to the receiver’s and sender’s setting and status.

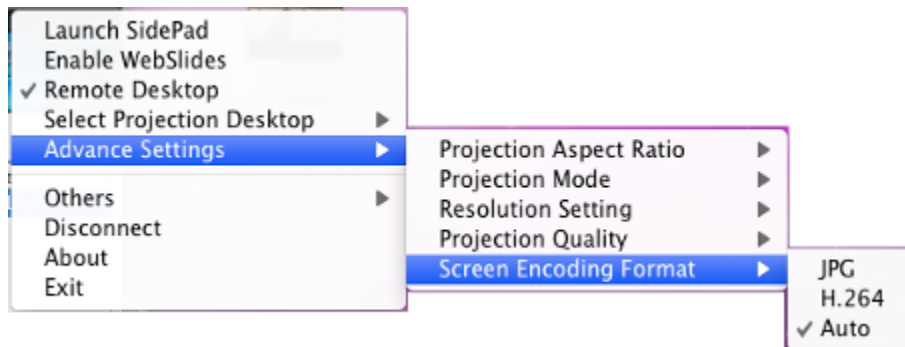

9.10.6 Others

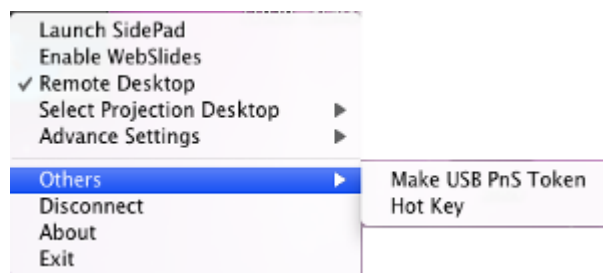

9.10.6.1 Make USB PnS Token

- 1) Click “Make USB PnS Token” to make a USB wePresent WiPG-2000 Token, you can insert a USB and follows the wizard to make the Token. After completion, you can plug the USB to any PC to do the projection without installing the wePresent WiPG software onto every PC.

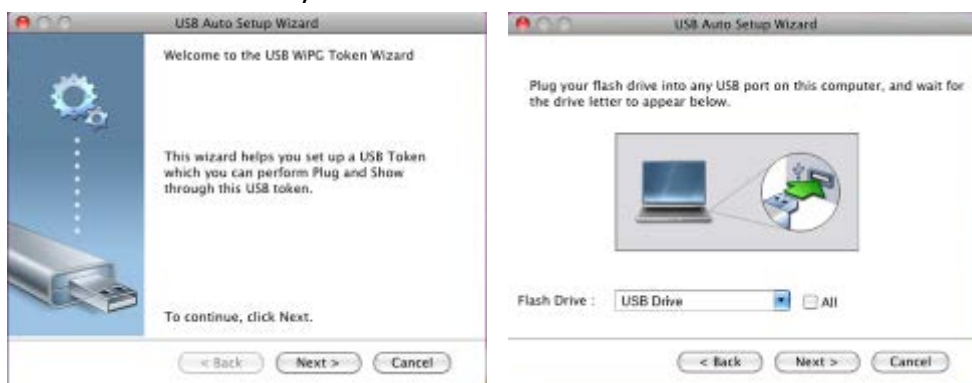

9.10.6.2 Hot Key

- 1) Click on “Hot Key” to display the available Hot Key definition.

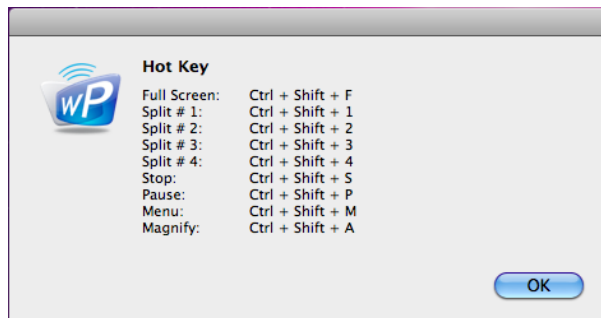

9.10.7 Disconnect

- 1) Click on “Disconnect” to disconnect from current connected receivers.

9.10.8 About

- 1) Click on “About” to show system information. It includes product model name, Application version.



9.10.9 Exit

- 1) Click on “Exit” to exit this application. It will stop current playing status and shut down the application immediately.

10 Web Management

10.1 Home Page

- 1) Make sure your PC connect to wePresent WiPG-2000 box successfully.
- 2) Enter the receiver IP address on your browser; you can find the IP address on the projector/display screen. (Default IP is 192.168.100.10).
- 3) Your browser will lead you to the below page.



10.2 Download

- 1) Select "Download" function.
- 2) Please select the "Win 8 / 7 / Windows Vista / XP" or "Mac Utility" and execute the installation program.

Note: Please disable the "Smart Screen Filter" on IE browser; otherwise you might not able to download the file.

Download
Conference Control
Admin

WebSlides
(View Projecting Screen)

Installation Version: (Administrator privilege required)

You can download Utility for Windows from here.

(Windows XP / Vista / 7 / 8)

Note:
For Internet Explorer 8 and above, please disable the "SmartScreen Filter" first to download and install this software.

You can download Utility for MAC from here.

(MacBook 10.5 ~ 10.9)

Executable Version: (No installation required)

You can download Utility for Windows from here.

(Windows XP / Vista / 7 / 8)

Note:
For Internet Explorer 8 and above, please disable the "SmartScreen Filter" first to download and install this software.

You can download Utility for MAC from here.

(MacBook 10.5 ~ 10.9)

10.3 Conference Control

- 1) Select "Conference Control" function, you can find the current connected user list on this page. Please make sure the lock on the start page is disabled. 
- 2) Enter password and then press [Login]. (default password: moderator)

wePresent

wePresent-WiPG > Conference Control

Download
Conference Control
Admin

WebSlides
(View Projecting Screen)

User Name **moderator**

Password

(Default password: moderator)

Name	IP Address
Pete-VAIO	192.168.100.11

Copyright © 2012. All Rights Reserved

- 3) After login, you can see a User List on the screen which indicates all of the users connected to wePresent WiPG-2000 box.
- 4) The default setting is "allow control from this page only". When this function is checked, the moderator can control all the login users' projection.

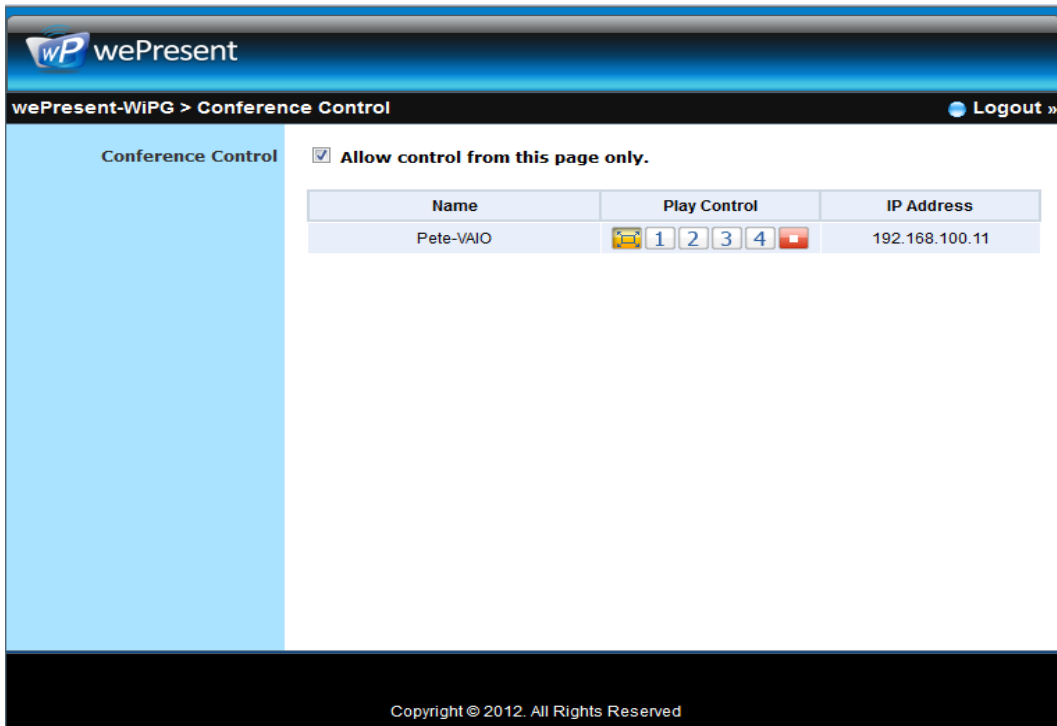

- 5) There are three columns, “Computer Name”, “Play Control” and “IP Address”.
 - a. Play Control: There are six buttons, including Play(Full) , Screen #1 , Screen#2 ,Screen #3 , Screen#4 and Stop .
 - b. Moderator can click on the “play” button to allow the projecting.
 - c. Moderator can assign which user to project on which screen by clicking on the screen numbers.
 - d. Moderator can “stop” the projecting anytime.
- 6) Uncheck the “Allow Control from this page only”, it will disable the centralized control and user can project the screen to WiPG-2000 freely.
- 7) Moderator can log out from the conference control mode by clicking on the” log out” on the upper right corner.

10.4 Admin

- 1) Click on “Admin” and then enter the password to login web admin page. **(Default Password: admin)**

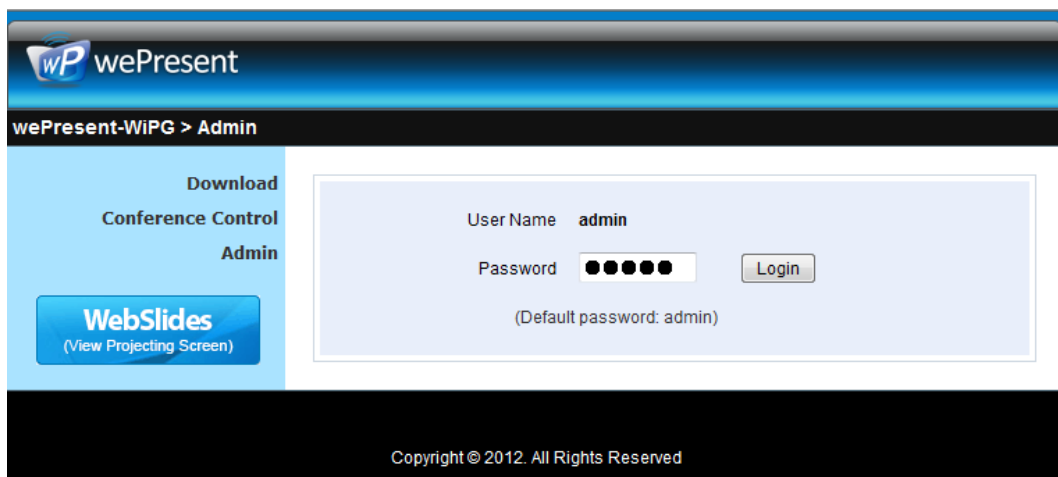

10.5 System Status

1) Click on “System Status” option, it will show current system status.

Model Name: Product model name

Versions:

- **Firmware version no.:** Product firmware version number.

Device Information:

- **Resolution:** Device output resolution.
- **Host Name:** Device network hostname.

Network Status:

- **IP address :** IP address of WiPG-2000 device.
- **Subnet Mask :** subnet mask
- **Default Gateway :** default gateway
- **Wireless MAC address :** wireless MAC address
- **Wire MAC address :** wire MAC address

WiFi Information:

- **WiFi Mode :** Access Point/WiFi Station/Concurrent AP-Station Mode
- **SSID :** Current SSID or the connected WiFi AP name.

Connection Status:

- **Projecting status:** “Waiting for projecting” or “Projecting”
- **Total Users:** It shows how many users login to wePresent WiPG-2000.
- **Code:** It will show current Code

Date and Time:

- **Date:** Current date.
- **Time:** Current time.
- **Time Zone:** Current Time zone.

wePresent-WiPG > Admin > System Status		Logout »
System Status	Model Name	WIPG-2000
Device Setup	Versions	
Network Setup	Firmware Version	0.0.3.8
WiFi Setup	Device Information	
SNMP Setup	Resolution	1280 x 720 (720p)
OSD Setup	Host Name	WIPG-2000-00E
WebSlides Setup	Network Status	
Change Passwords	IP Address	10.102.2.84
Reset to Default	Subnet Mask	255.255.255.0
Firmware Upgrade	Default Gateway	10.102.2.1
Reboot System	Wireless MAC Address	00:12:5F:09:F9:82
	Wire MAC Address	00:12:5F:00:10:0E
	WiFi information	
	Mode	WiFi Access Point Mode
	SSID	WIPG-2000-00E
	Connection Status	
	Projecting Status	Waiting for Projecting
	Total Users	1
	Code	Disable
	Date and Time	
	Date	--
	Time	--
	Time Zone	--

10.6 Device Setup

- 1) Click on “Device Setup” option, it will show the device setting items,
 - Choose **<VGA>** or **<HDMI>** output option
 - **<Resolution>**:
VGA: UXGA(1600*1500), WXGA+(1440*900), WXGA(1360*768, 1280x768, 1280x800) ,XGA(1024*768), and SVGA(800*600). The default value is XGA(1024*768).
HDMI: 720p, 1080i, 1080p
 - **<Code>**: You can select “Disable”, “Random”, or “Use the following code” to set a specified 4-characters Number.
- 2) Click on “Date and Time Settings” option, it will show the time setting items,
 - Choose **<SNTP/NTP Server Synchronization>** or **<Disable>** to specify the time server or disable this feature.
 - **<Time Zone>**: Specify the time zone.

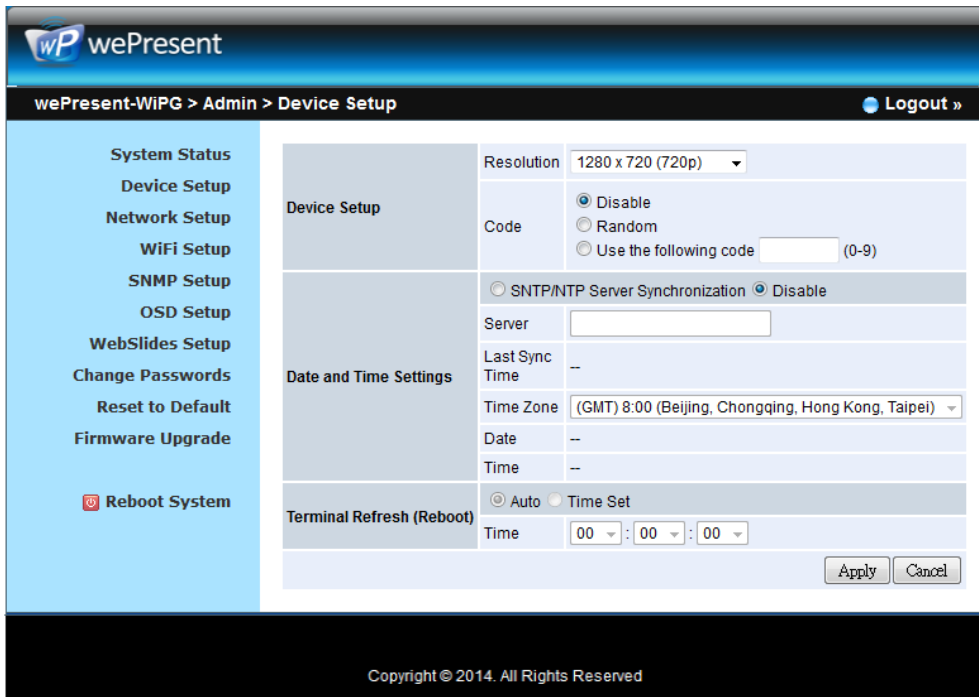

10.7 Network Setup

1) Click on “Network Setup” option, it will show the network setting items,

< Host Name and Domain Name >

- Host Name: Enter the hostname of this device.
Note: You can enable the “use the same name as network name”, it will use the same name as SSID for the device host name.
- Domain Name: You can also enter the domain name of this device if there is DNS server available.

< IP Setup >

- You can select “obtain IP address automatically” or “Use the following IP address” to enter the IP address.

The default setting is as following:

- IP Address: 192.168.100.10.
- Subnet Mask: 255.255.255.0
- Default Gateway: 192.168.100.10
- DNS Server: 192.168.100.10

<DHCP Server Setup >

<Note: Auto-Configuration Network Setup on WiPG-2000 >

The default setting of the wePresent WiPG-2000 box as DHCP server. When the wePresent WiPG-2000 box is connected to a LAN that already has a DHCP server, the wePresent WiPG-2000 box uses an IP address assigned by the server. When the wePresent WiPG-2000 box is connected to a LAN that does not have a DHCP server, the wePresent WiPG-2000 box becomes the DHCP server in the network.

- You can select “auto” option. WiPG-2000 will auto disable the DHCP server setup when the existing DHCP server is detected. Or you can simply select “Disable” option. When you choose “Auto” option, you can enter the below information or keep it as default setting.

Start IP: 192.168.100.11

End IP: 192.168.100.254

Subnet Mask: 255.255.255.0

Default Gateway: 192.168.100.10

DNS Server: 192.168.100.10

< Gatekeeper >

Gatekeeper is designed for ensuring the enterprise network security within wePresent WiPG-2000 box

- “All Block” can block Guest Users(through wireless) to access all office network(LAN),
- “All Pass” can allow Guest Users(through wireless) to access all office network
- “Internet Only” can block Guest Users (through wireless) from office network (LAN) but still reserve internet connection capability.

<Apply >: Press “Apply” button after configuration, and follow the reboot instruction when applicable.

<Cancel >: Press button to abort action.

The screenshot shows the 'wePresent' admin interface for 'Network Setup'. The left sidebar contains navigation links: System Status, Device Setup, Network Setup (selected), WiFi Setup, SNMP Setup, OSD Setup, WebSlides Setup, Change Passwords, Reset to Default, Firmware Upgrade, and Reboot System. The main content area is divided into sections: 'Host Name and Domain Name' with fields for Host Name (WIPG-2000-00E) and Domain Name, and a checked checkbox 'Same as WiFi Network name'; 'IP Setup' with radio buttons for 'Obtain an IP address automatically' (selected) and 'Use the following IP address', and fields for IP Address (192.168.100.10), Subnet Mask (255.255.255.0), Default Gateway (192.168.100.10), and DNS Server (192.168.100.10); 'DHCP Server Setup' with radio buttons for 'Auto' (selected) and 'Disable', and fields for Start IP (192.168.100.11), End IP (192.168.100.254), Subnet Mask (255.255.255.0), Default Gateway (192.168.100.10), and DNS Server (192.168.100.10); and 'GateKeeper' with radio buttons for 'All Pass' (selected), 'All Block', and 'Internet Only'. 'Apply' and 'Cancel' buttons are at the bottom right.

10.8 WiFi Setup

- Wireless LAN: The default setting is “Enable”
- Mode: Specify the WiFi Access Point mode, WiFi Station mode and Concurrent AP and Station Mode.

< Access Point Mode>

- SSID: You can change the default SSID and the maximum Length is 32 bytes.
- SSID Broadcast: The default value is “Enable”
- Channel: You can set a fixed channel or allow auto selection. The “Auto” selection means after power on wePresent WiPG-2000, it will scan all of wireless channels and select one clear channel automatically.
- Encryption: you can select “Disable” or one of WEP/WPA PSK/WPA2 PSK/ WPA Enterprise/ WPA2 Enterprise.
- Key: If Encryption is enabled, you have to enter a key according to the encryption mode you selected. (If the length of the key entered is not sufficient or too long, a warning message will pop up.)
- Channel Bandwidth: select from 20M or Auto (20M/40M)

The screenshot displays the wePresent WiFi Setup interface. The top navigation bar shows 'wePresent-WiPG > Admin > WiFi Setup' and a 'Logout' button. A left sidebar lists various system settings: System Status, Device Setup, Network Setup, WiFi Setup (highlighted), SNMP Setup, OSD Setup, WebSlides Setup, Change Passwords, Reset to Default, Firmware Upgrade, and Reboot System. The main content area is titled 'Access Point' and contains the following configuration options:

Wireless LAN	<input checked="" type="radio"/> Enable <input type="radio"/> Disable
Mode	<input checked="" type="radio"/> AP <input type="radio"/> Client <input type="radio"/> AP_Client
SSID	WiPG-2000-00E
Region	WORLDWIDE
SSID Broadcast	<input checked="" type="radio"/> Enable <input type="radio"/> Disable
802.11mode	802.11 B/G/N mixed
Channel	Auto
Encryption	Disable
Key	<input type="text"/> <input checked="" type="checkbox"/> Hide characters
Channel Bandwidth	<input type="radio"/> 20MHz <input checked="" type="radio"/> Auto

Buttons for 'Apply' and 'Cancel' are located at the bottom right of the configuration area. The footer of the interface reads 'Copyright © 2014. All Rights Reserved'.

< Station Mode>

- Connect to Existing AP: The default setting is “Disable”. If you choose “Enable” you need to enter the existing AP SSID that you want to connect. When you select “Enable” option, the following information needs to be entered accordingly to the existing AP setting:
Encryption: Select “Disable” or one of WEP/WPA PSK/WPA2 PSK/ WPA Enterprise/ WPA2 Enterprise.

Key: If Encryption is enabled, you have to enter a key according to the encryption mode you selected. (If the length of the key entered is not sufficient or too long, a warning message will pop up.)

Note: The Encryption and Key information must be consistent to the exiting AP configuration.

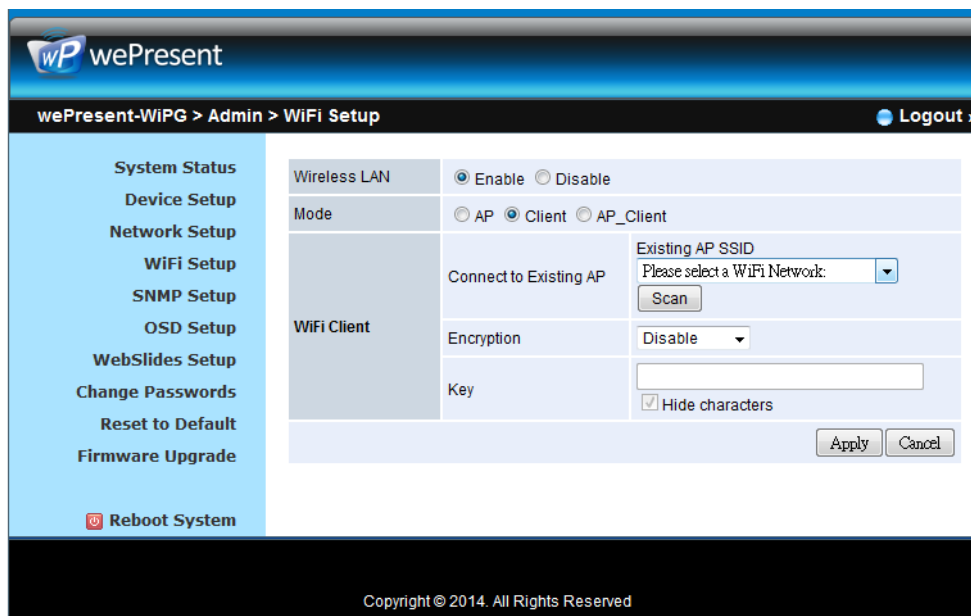

< Concurrent AP and Station Mode >

Access Point

- SSID: You can change the default SSID and the maximum Length is 32 bytes.
- SSID Broadcast: The default value is “Enable”
- Channel: You can set a fixed channel or allow auto selection. The “Auto” selection means after power on wePresent WiPG-2000, it will scan all of wireless channels and select one clear channel automatically.
- Encryption: you can select “Disable” or one of WEP/WPA PSK/WPA2 PSK/ WPA Enterprise/ WPA2 Enterprise.
- Key: If Encryption is enabled, you have to enter a key according to the encryption mode you selected. (If the length of the key entered is not sufficient or too long, a warning message will pop up.)
- Channel Bandwidth: select from 20M or Auto (20M/40M)

WiFi Station:

- Connect to Existing AP: The default setting is “Disable”. If you choose “Enable” you need to enter the existing AP SSID that you want to connect. When you select “Enable” option, the following information needs to be entered accordingly to the existing AP setting:
Encryption: Select “Disable” or one of WEP/WPA PSK/WPA2 PSK/ WPA Enterprise/ WPA2 Enterprise.
Key: If Encryption is enabled, you have to enter a key according to the

encryption mode you selected. (If the length of the key entered is not sufficient or too long, a warning message will pop up.)

Note: The Encryption and Key information must be consistent to the exiting AP configuration.

<Apply >: Press “Apply” button after configuration, and follow the reboot instruction when applicable.

<Cancel>: Press button to abort action.

The screenshot displays the 'wePresent' web interface for 'WiFi Setup'. The left sidebar contains navigation options: System Status, Device Setup, Network Setup, WiFi Setup (highlighted), SNMP Setup, OSD Setup, WebSlides Setup, Change Passwords, Reset to Default, Firmware Upgrade, and Reboot System. The main content area is divided into three sections: 'Wireless LAN' (Enable/Disable), 'Access Point' (Mode: AP, Client, AP_Client; SSID: WiPG-2000-00E; Region: WORLDWIDE; SSID Broadcast: Enable; 802.11mode: 802.11 B/G/N mixed; Channel: Auto; Encryption: Disable; Key: [input field]; Hide characters: checked; Channel Bandwidth: 20MHz, Auto), and 'WiFi Client' (Connect to Existing AP: Existing AP SSID, Please select a WiFi Network: [dropdown]; Scan; Encryption: Disable; Key: [input field]; Hide characters: checked). 'Apply' and 'Cancel' buttons are at the bottom right.

10.9 SNMP Setup

- Enable or disable SNMP V3 service
- User Name: configure the user name to manage this device through SNMP
- Auth Password: configure the Auth password
- Priv Password: configure the Priv password
- Trap IP: configure the trap receiver IP

<Apply >: Press “Apply” button after configuration, and follow the reboot instruction when applicable.

<Cancel>: Press button to abort action.

Note:

For more information about SNMP V3, you can find it on USB token. \User Manual\WiPG-2000_SNMP Instructions.pdf

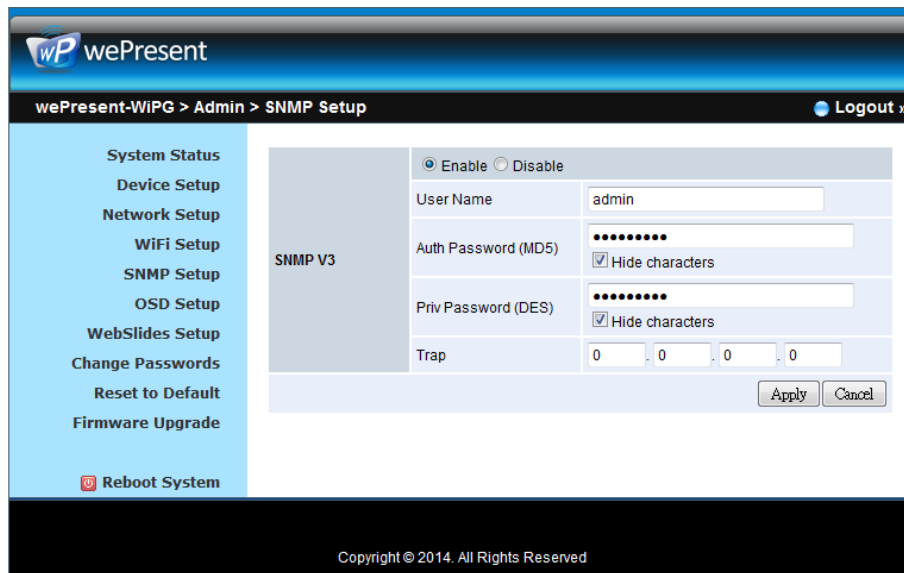

10.10 OSD Setup

1) Click on “OSD Setup” option, you can:

Change Standby Image

- **<Reset to default>**: Restore to default Logo image.
- **<Image File Upload>**: Enter or browse the file name and upload the customized Image. Please refer to remark on screen when select the file.

You can also adjust the following “Display Option”

- **Device Information: Show or Hide the device Info.**
- **User List: Show or hide the User List.**
- **Connection Info: Show or hide the overlay connection info.**
- **Font Size: Adjust the Font size of system information.**
- **Screen Saver Settings:** Enable or disable the screen saver and also configure the idle time(Minutes). (default is 5 mins)

<Apply >: Press “Apply” button after configuration, and follow the reboot instruction when applicable.

<Cancel>: Press button to abort action.

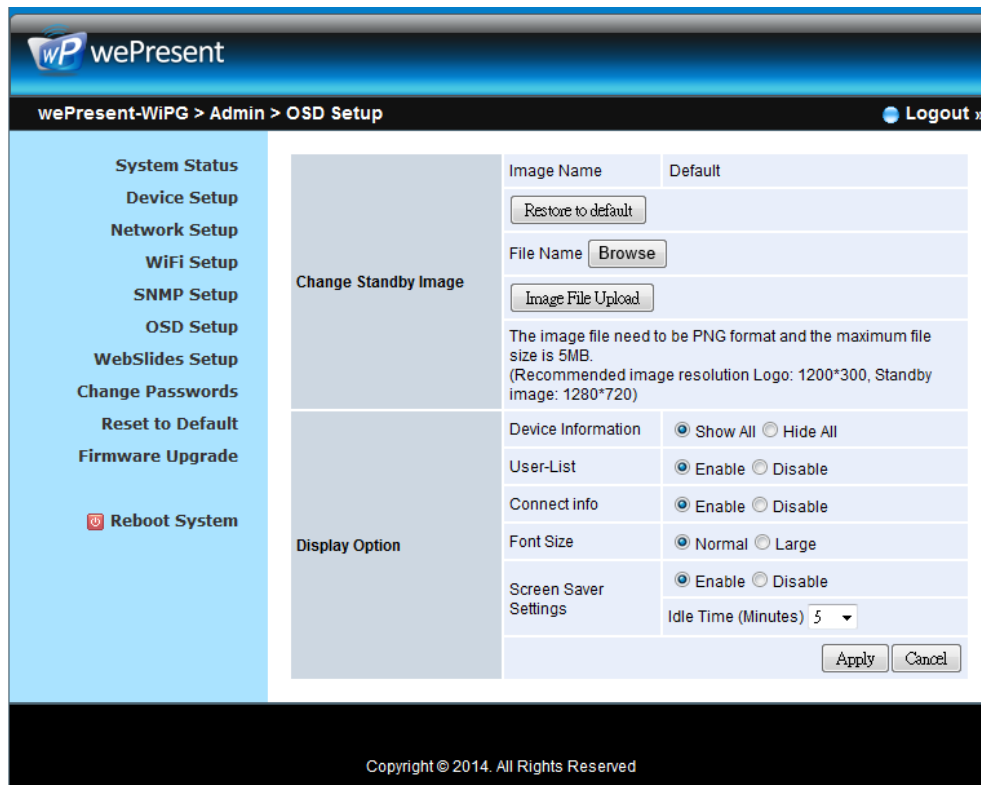

10.11 WebSlides Setup

1) Click on “WebSlides Setup” option, you can:

Adjust Auto ReFresh Interval, or activate “Access Password Control”

Please pay attention on the note for information.

<Apply >: Press “Apply” button after configuration, and follow the reboot instruction when applicable.

<Cancel>: Press button to abort action.

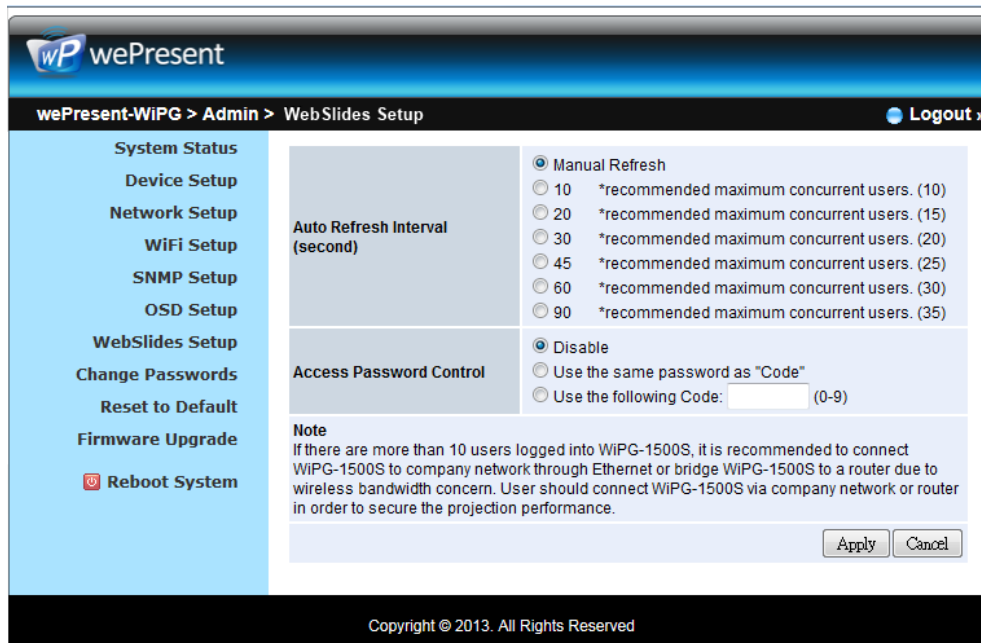

10.12 Change Passwords

1) Click on “Change Password” option, you can change the password setting for “conference control” and “Admin”.

(Length: up to 8 characters)

- <Enter New Password>
- <Confirm New Password>
- <Apply>: Confirm and Save modifications.

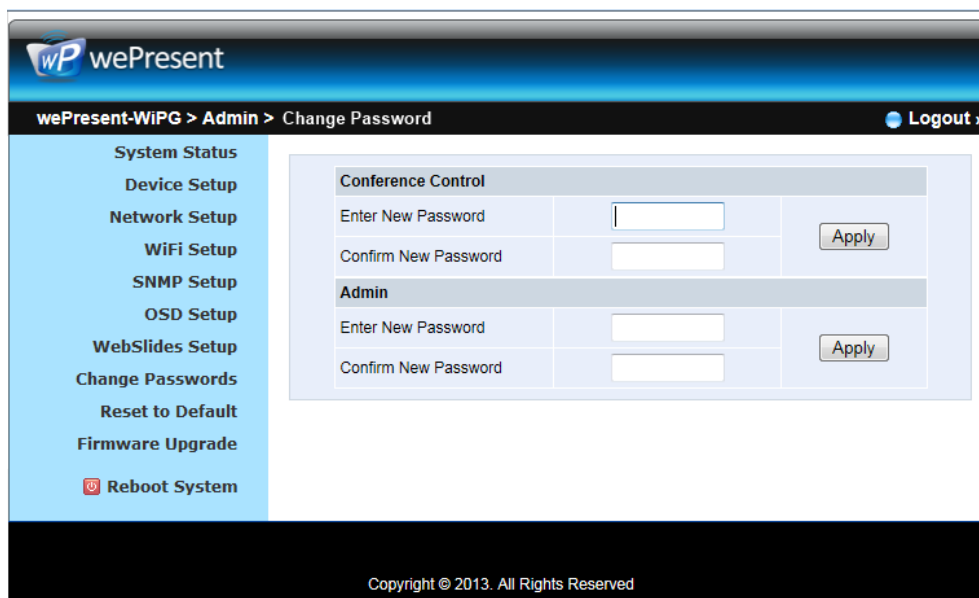

10.13 Reset to Default

1) Click on “Reset to Default” option to restore factory default settings.

<Apply>: Confirm and take action.

***** You can also restore factory default setting from WiPG-2000 box reset button.**

You can find the reset button underneath the box. Please follow below procedures.

1. Press [**Reset**] button and **Hold**.
2. Turn on wePresent WiPG-2000 box.
3. Press more than 10 seconds and relief [**Reset**] button.
4. It will take effect to restore factory default settings.

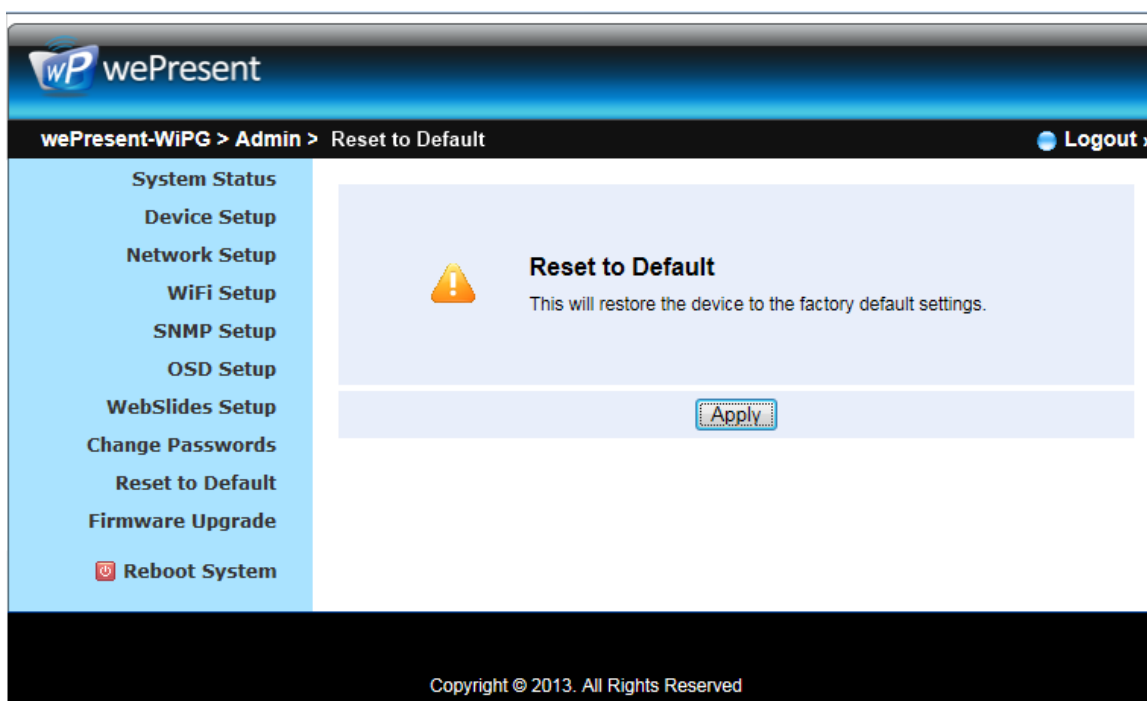

10.14 Firmware Upgrade

1) Click on “Firmware Upgrade” option to “import/export” system configuration and upgrade firmware.

2) System Configuration Import and Export

Export: Export the system configuration to a configuration file

Import: Import the system configuration file to WiPG-2000

3) You can find the firmware version and release date here.

4) Firmware Upgrade

A. Firstly, you have to get latest firmware image file from your vendor.

- B. Click **<Browse>** to specify file name you want to upgrade.
- C. Click **<Upgrade>** to start.
- D. A warning message shown and count down counter on the screen.
- E. After a few minutes, a complete message shown on the screen.
- F. Restart wePresent WiPG-2000 box to take effect.

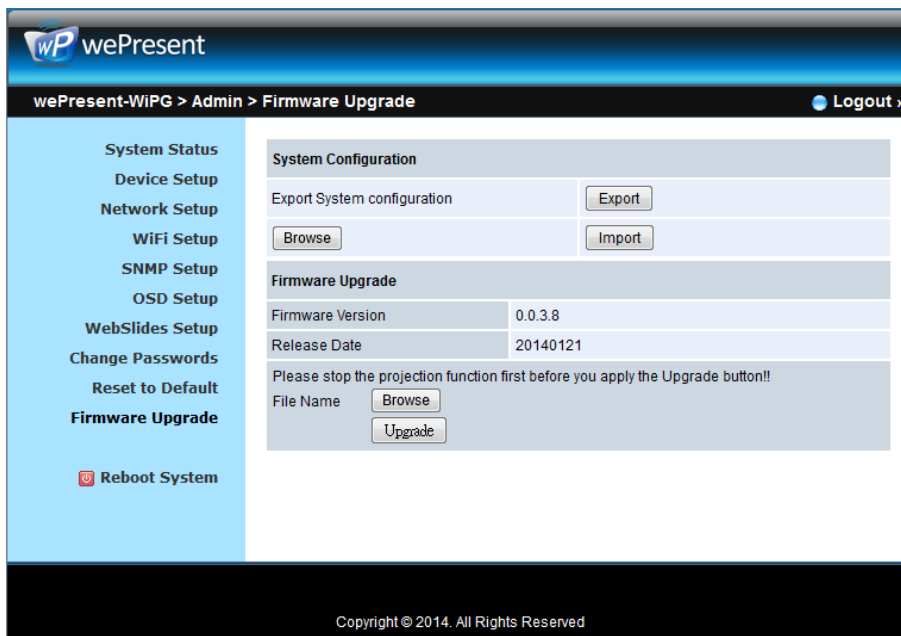

Please wait while System burns new firmware into your device.

Warning: It needs to take 2 - 5 minutes to burn the file you transferred into flash memory. **During this period, any interrupt such as shut down or reboot the system will cause system crash!!**

Estimated Time remaining: 90 seconds

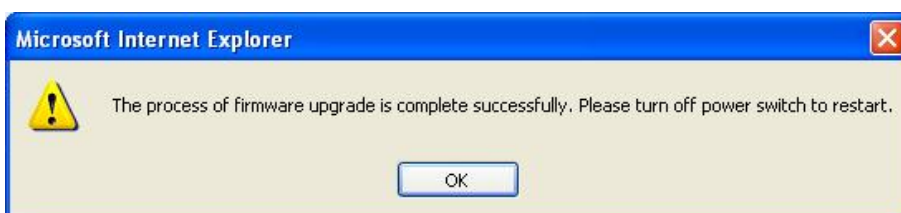

Warning: Don't power off wePresent WiPG-2000 while firmware upgrade in progress, otherwise you will damage your box and have to return device to your vendor for fixing.

10.15 Reboot System

- 1) Click on "Reboot System" option, you can restart the system
 - ◆ **Click on <Reboot >button:** reboot system automatically.

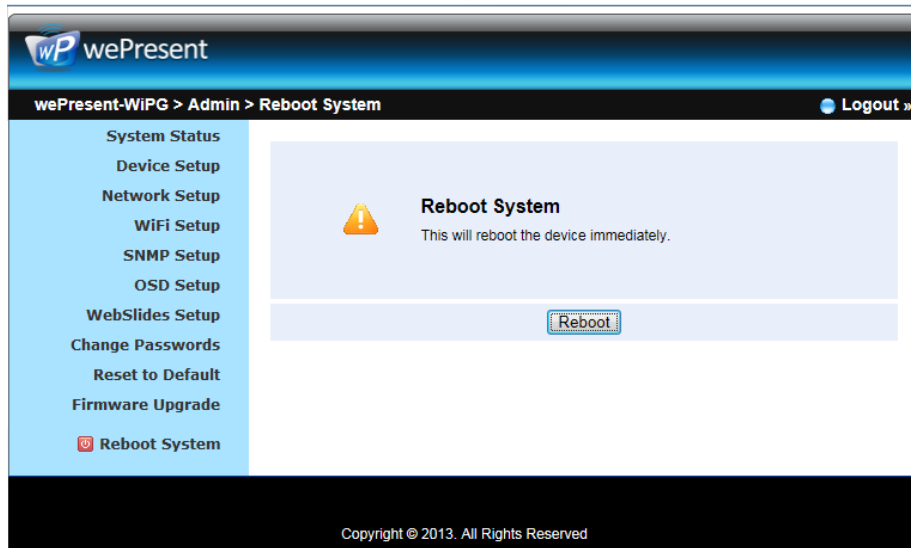

10.16 Logout

- 1) Click on “logout” on the up right corner, you can logout the administration webpage and return back to the web management front page.

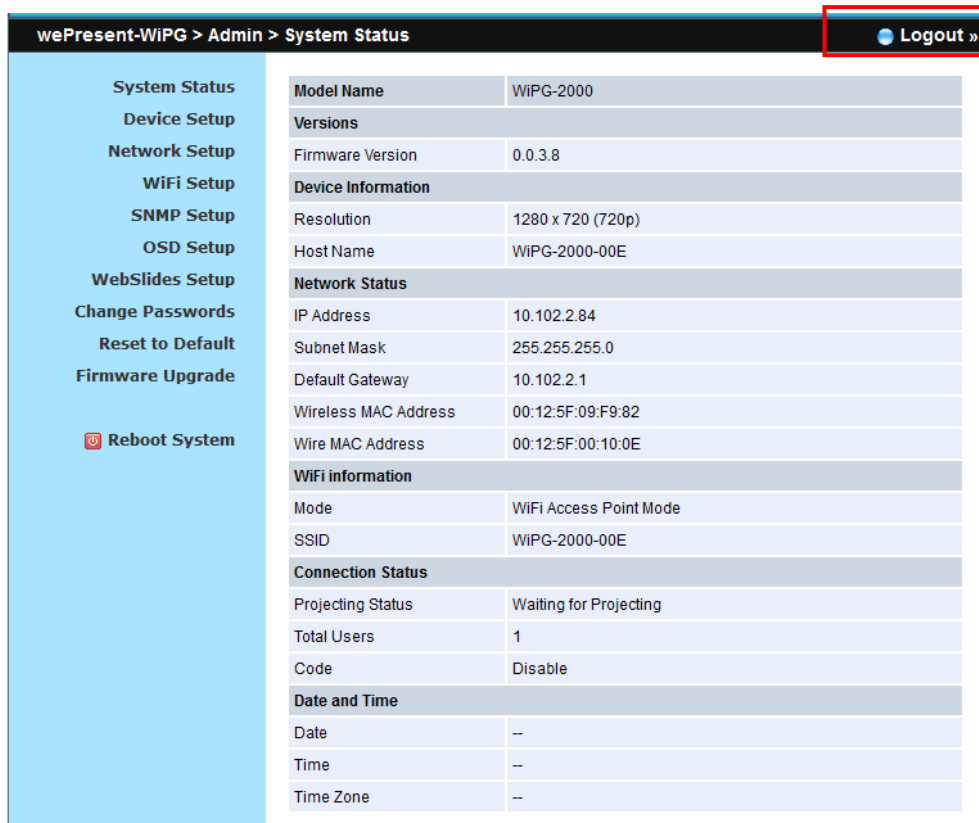

10.17 WebSlides

- 1) Press the “WebSlides” button to enter the WebSlides page.
- 2) Please refer to 8.10.5 Launch Webslides for more information.







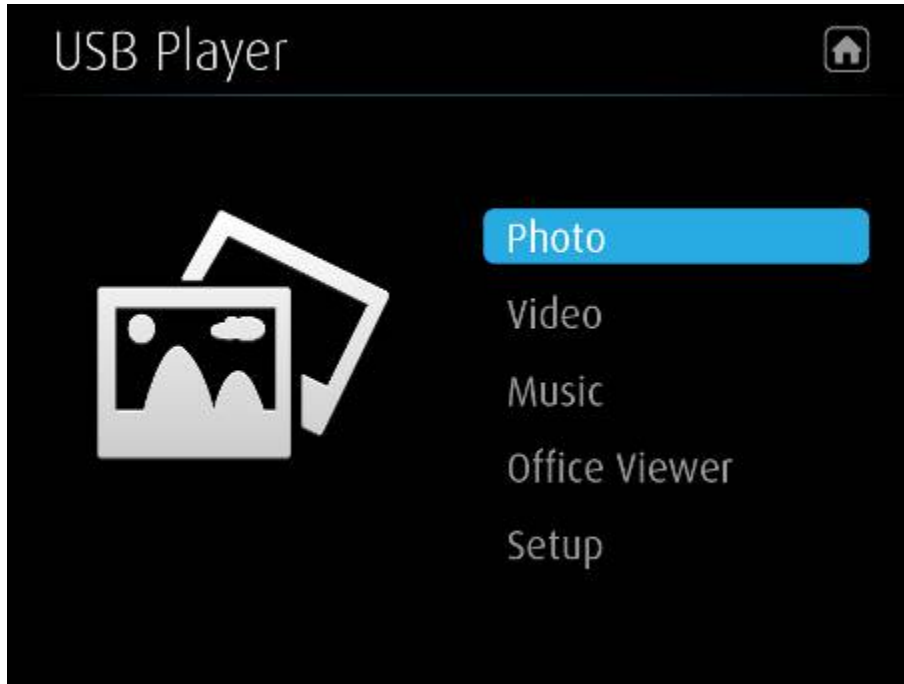

11

USB Player

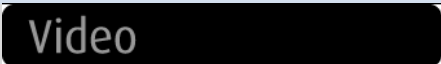
The USB Player can playback the files stored in the attached USB drive, it can support photo/video/music/office files.

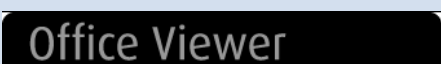



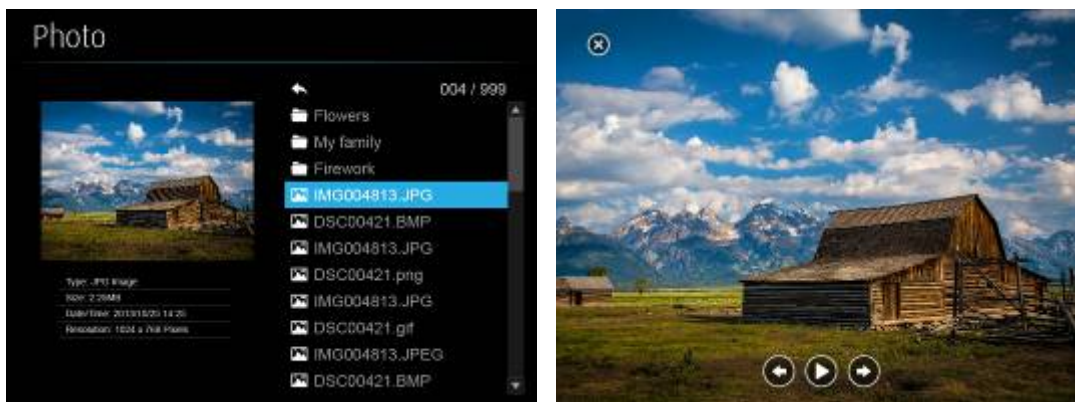

Button	Description
	Switch to Projection mode.
	Enter photo viewer function.
	Enter video player function.
	Enter music player function.
	Enter Office Viewer function.
	Enter Setup Page.

11.1 Photo Viewer

Open the folder and find the photo file to play on the local display.





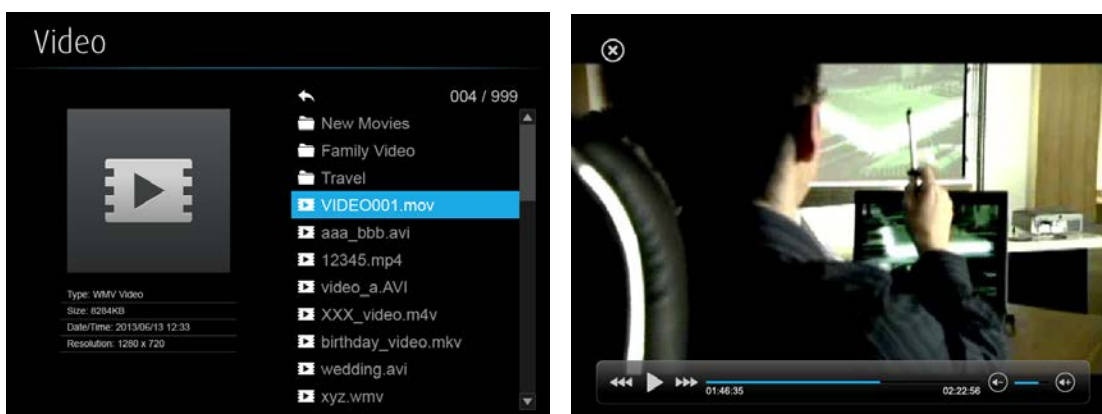

Button	Description
	Exit this file.
	Go to previous file.
	Start/Pause Slideshow.
	Go to next file.

11.2 Video Player

Open the folder and find the video file to play on the local display.









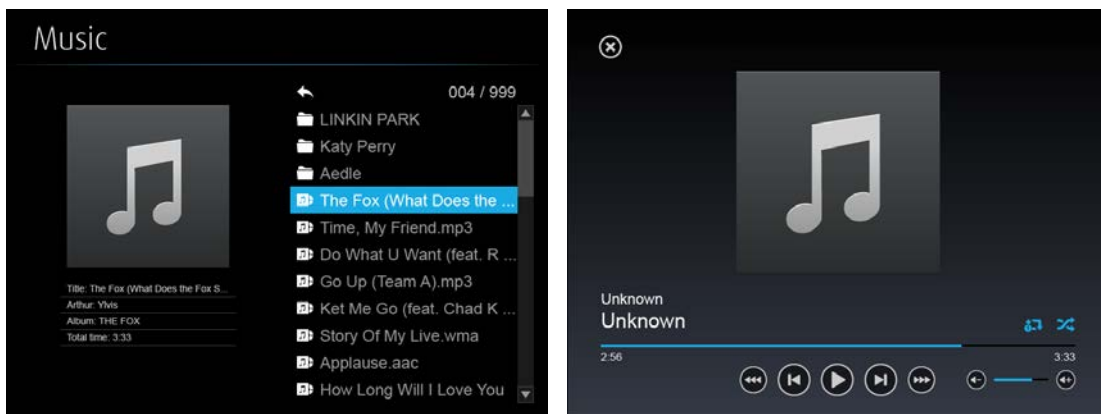

Button	Description
	Exit this file.
	Fast-rewind. (2x/4x/8x)
	Play/Pause.
	Fast-forward. (2x/4x/8x)
	Volume level increase/decrease.

11.3 Music Player

Open the folder and find the music file to play on the local display.



Button	Description
	Exit this file.
	Fast-rewind. (2x/4x/8x)
	Go to previous file.
	Play/Pause.
	Go to next file.
	Fast-forward. (2x/4x/8x)
	Volume level increase/decrease.
	Repeat All files/Repeat Single File



Shuffle.

11.4 Office Viewer

Open the folder and find the document file to play on the local display.



Button	Description
	Exit this file.
	Go to previous page.
	Go to next page.



11.5 Setup

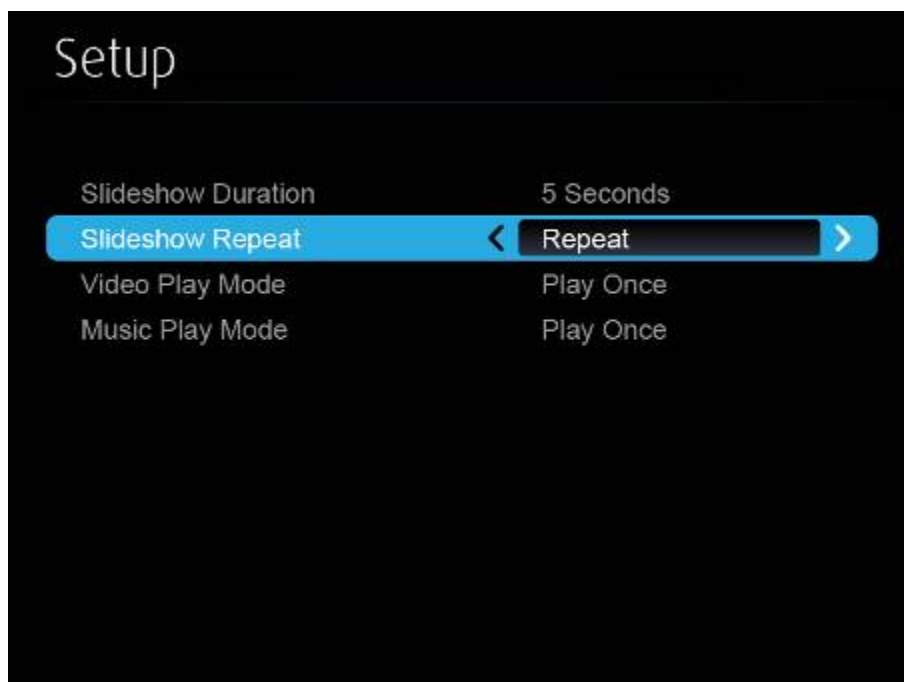

Items	Description
Slide Show Duration	5/10/20/30 seconds.
Slide Show Repeat	Repeat on/off.
Video Play mode	Repeat on/off.
Music Play mode	Repeat single file, Repeat all files.

Note:

Item:	Value
Supported File Format	MPEG-1 / MPEG-2 / MPEG-2 TS / MPEG-4 / MWW9 / MOV / Motion JPEG / MKV / ASF / DVR-M5
Supported Video Codec	MPEG-1 / MPEG-2 / MPEG-2 TS / MPEG-4* / WMV9** / QuickTime / Motion JPEG * Microsoft MPEG-4 v1-3 is not supported. ** Only WMV3/WVC1 is supported.
Supported Audio Codec	LPCM / AAC / MP3 / WMA
Supported Office File	Word, Excel, PowerPoint(up to Office 2010), Pdf. Details: http://www.awindinc.com/WiFi-Doc/format.html

* All formats support up to 1920x1080, 30fps, and 20Mbps.

* These file formats might include video and audio codecs which are not supported.