

Pioneer Dj

DJ controller

DDJ-RZ

 **rekordbox** rekordbox dj

<http://pioneerdj.com/support/>

The Pioneer DJ site shown above offers FAQs, information on software and various other types of information and services to allow you to use your product in greater comfort.

<http://rekordbox.com/>

For the latest version of the rekordbox software, access rekordbox.com and download the software from there.

Operating Instructions

Contents

How to read this manual

- Thank you for buying this Pioneer DJ product.
Be sure to read this manual and the “Operating Instructions (Quick Start Guide)” included with the unit. Both documents include important information that you should understand before using this product.
- In this manual, names of screens and menus displayed on the product and on the computer screen, as well as names of buttons and terminals, etc., are indicated within brackets. (e.g.: [CUE] button, [Files] panel, [MIC1] terminal)
- Please note that the screens and specifications of the software described in this manual as well as the external appearance and specifications of the hardware are currently under development and may differ from the final specifications.
- Please note that depending on the operating system version, web browser settings, etc., operation may differ from the procedures described in this manual.

This manual consists mainly of explanations of functions of this unit as hardware. For detailed instructions on operating the rekordbox software, see the rekordbox software’s manual.

- For obtaining the rekordbox software’s manual, see *Acquiring the manual* (p. 29).

01 Before start

Features	3
What’s in the box	4
Preparing the software	4

02 Connections and part names

Connections	6
Part names and functions	8

03 Basic Operation

Connecting this unit and computer	13
Starting the system	14
Quitting the system	15

04 Advanced Operation

Using the performance pads	16
Using the slip mode	18
Using the dual deck mode	19
Using the fader start function	19
Adjusting the crossfader’s operating load	20
Using effects	20
Using the beat FX function	20
Using the release FX	21
Using the SOUND COLOR FX function	21
Using the oscillator function	22
Using external inputs	22

05 Changing the settings

Launching utilities mode	24
Utilities modes	24
About the setting utility software	26

06 Additional information

Troubleshooting	28
Signal flow	29
Acquiring the manual	29
Using as a controller for other DJ software	29
About trademarks and registered trademarks	29
Cautions on copyrights	30

Before start

Features

This unit is an all-in-one DJ controller designed specifically for rekordbox dj. It's interfaces incorporating various controls such as "BIG JOG", "PERFORMANCE PADS" and 4-channel mixer are positioned with room to spare to allow for more individualistic DJ performances using rekordbox dj. Also, the unit provides "SOUND COLOR FX" and "OSC SAMPLER" functions so that original arrangements can be added to the music being played back. Furthermore, numerous input and output terminals support a variety of DJ styles. Featuring aluminum material for the top panel, the design makes the unit look high quality, which is appropriate in a variety of scenes such as nightclubs, home parties, etc.

- rekordbox
 - rekordbox is a composite software that enables track management and DJ performances.
- rekordbox dj
 - The DJ performance function of rekordbox is called rekordbox dj. Enter the license key included with this product to use rekordbox dj.

BIG JOG & ON JOG DISPLAY

We have achieved the shortest time required from when jog is operated until when the control signal is transferred to the software. Additionally, "BIG JOG", a large sized jog, allows the DJ to play scratches as they wish with smooth operability. At the center of the jog, the "ON JOG DISPLAY" displays the playback status of music and the current playback position so that the DJ can perform scratching more accurately. Also, the unit is equipped with "JOG FEELING ADJUST", which is popular in the CDJ Series. It is possible to adjust the operation load and back spin continuous time during scratch play to match particular tastes.

MULTI-COLOR PERFORMANCE PADS

"MULTI-COLOR PERFORMANCE PADS", large rubber pads used to operate functions such as HOT CUE, PAD FX, and SAMPLER, are positioned at the front of the unit.

Music can be arranged by dynamic actions such as beating and rolling and the volume of the sampler can be increased or decreased depending on the strength of the beat.

Also, each pad has built-in multi-color illumination so you can instantaneously understand the information required for your performance from the color and lighting state of the pad.

SEQUENCER

The "SEQUENCER" function that enables recording sampler operation patterns and playing back recorded sampler operation patterns can be intuitively operated from the included dedicated operation interface.

DJ performances full of originality are possible as the "SEQUENCER" function and dedicated operation interface can be used to easily create phrases using sounds loaded in the sampler.

4-CHANNEL MIXER

The unit includes "4-CHANNEL MIXER", which allows the DJ to independently operate songs being played back with four decks. Four songs can be mixed to create a highly individualistic DJ mix.

Level meters are located near the master unit and the operation interface of each channel, so that input and output levels can be understood instantly.

This unit retains the control panel layout of the Pioneer DJM series, the world standard in DJ mixers.

The simple, easy-to-understand control panel layout not only facilitates DJ performances but also makes it easy for DJs using the unit for the first time to operate it without hesitation, so it can be used without worry as a permanently installed mixer in the club.

OSC SAMPLER

The unit is equipped with the "OSC SAMPLER" function for generating four types of sound (NOISE, SINE, SIREN, and HORN). Operation is simple. Just press the button of the sound type you wish to output. You can take music to an entirely new level by superimposing oscillator sound over the music you are playing back or further emphasizing the climax of music. Also, you can change the tone by simply turning the [OSC SAMPLER PARAMETER] control, making it possible to generate oscillator

sound that is matched to the music. Furthermore, you can use sample sounds saved to the OSC SAMPLER in "rekordbox dj".

SOUND COLOR FX

The unit is equipped with four "SOUND COLOR FX" functions (SPACE, JET, PITCH, and FILTER) for achieving a wide range of musical arrangements.

By simply turning the control, it is possible to create the effect you want, and a variety of remix can be achieved such as adding original arrangements to the music.

Creative effect performances are also made possible by assigning your favorite SOUND COLOR FX included in "rekordbox dj".

PLUG AND PLAY DUAL USB PORT

Two USB sound cards are provided to connect the unit to up to two computers at the same time.

The sound cards of the unit and all buttons and controls are set to be linked with "rekordbox dj" beforehand so that the DJ can begin performances immediately using "rekordbox dj" without having to make troublesome settings.

The USB selector located at the top side can be used to switch between the two sound cards with a single action. When one DJ takes over from another, this function provides a smooth transition between the two computers without sound being interrupted.

FLEXIBLE CONNECTIVITY

Four external input systems and two MIC input systems are provided to connect to a CD player or analog turntable.

Mixing is possible without going through a computer, so the unit can be used as a single DJ mixer as well.

In addition, two MASTER OUT systems and one BOOTH OUT system are provided to handle professional PA device output.

All kinds of party scenes and DJ playing styles are supported.

DURABLE FADER

A slide structure is used for the crossfader and channel fader, in which the fader knob is supported by two metal shafts.

This achieves smooth operability without wobble and also high durability.

Also, effects on inside the faders caused by liquid and dust are minimized.

An independently developed "MAGVEL FADER" magnetic system is equipped for the crossfader to support scratch play, which provides high durability of more than 10 000 000 operations, and fine operability.

HIGH SOUND QUALITY

Leveraging the audio circuit of Pioneer audio devices for clubs, the unit provides powerful sound quality faithful to the original. It also reduces contact resistance through use of an AC inlet having a wide contact area with the power cable, and achieves stable and powerful sound even in the DJ booth in a loud environment.

By adopting a high performance D/A converter and low jitter crystal oscillator made by Wolfson Microelectronics, the unit reproduces clear and powerful club sound faithful to the original.

PROFESSIONAL QUALITY DESIGN

Aluminum material on the top panel and jog plate provides a sense of high quality design.

This unit is an essential part of DJ performance in clubs and home party scenes.

SLIP MODE

This unit is equipped with a SLIP MODE function to enable sound to continue in the background while operations such as looping, scratching, and hot cueing are being performed. This means operations such as looping, scratching, and hot cueing can be performed without changing the original track's composition.

NEEDLE SEARCH

Points can be searched for simply by touching the touch pad with a finger. This makes for intuitive, speedy searching with the sense of touching the music directly.

What's in the box

- Power cord
- USB cable^[1]
- Warranty (for some regions only)^[2]
- Operating Instructions (Quick Start Guide)
- rekordbox dj license key

[1] Only one USB cable is included with this unit.

To connect two units, use a cable conforming to USB 2.0 standards.

[2] Products for Japan and Europe only. (For the North American region, the corresponding information is provided on the last page of both the English and French versions of the "Operating Instructions (Quick Start Guide)".)

Cautions

The license key cannot be reissued. Be careful not to lose it.

Preparing the software

About rekordbox

❖ Acquiring rekordbox (Mac/Windows)

1 Launch a web browser on the computer and access the rekordbox site below.

<http://rekordbox.com/>

2 Download rekordbox from the rekordbox download page.

3 Install rekordbox and register the account.

4 Activate rekordbox dj.

- For instructions, see the rekordbox software's manual.

To activate the rekordbox dj function, enter the rekordbox dj license key supplied with this product.

About the driver software

This driver software is an exclusive driver for outputting audio signals from a computer.

- First read the *Software end user license agreement* on page 5 carefully.

Operating environment

Supported operating systems

Mac OS X 10.10 / 10.9 / 10.8 (latest update)		✓
Windows® 8/8.1 (latest service pack)	32-bit version	✓
	64-bit version	✓
Windows Pro® 8/8.1 (latest service pack)	32-bit version	✓
	64-bit version	✓
Windows® 7 Home Premium/Professional/Ultimate (latest service pack)	32-bit version	✓
	64-bit version	✓

Checking the latest information on the driver software

For the latest information on this unit's dedicated driver software, see the Pioneer DJ site below.

<http://www.pioneerdj.com/>

❖ Obtaining the driver software

1 Launch a web browser on the computer and access the Pioneer DJ site below.

<http://www.pioneerdj.com/>

- To switch the screen to Japanese display, scroll the screen to the bottom, click the [EN] indication at the bottom right of the screen and then select [JA].

2 Click [Support].

3 Click [Software & firmware updates].

4 Click [DDJ-RZ] in the [CONTROLLER] category.

5 After clicking [Drivers], download the latest driver software from the download page.

Download the driver for either Windows or Mac from the download page.

Installation procedure (Windows)

Do not connect this unit and the computer until installation is completed.

- Log on as the user which was set as the computer's administrator before installing.
- If any other programs are running on the computer, quit them.

1 Obtaining the driver software Double-click the file for Windows (DDJ-RZ_X.XXX.exe) downloaded in

The driver installation screen appears.

2 Carefully read the *Software end user license agreement* and if you consent to the provisions, put a check mark in [I agree.] and click [OK].

If you do not consent to the provisions of the *Software end user license agreement*, click [Cancel] and stop installation.

3 Proceed with installation according to the instructions on the screen.

If [Windows Security] appears on the screen while the installation is in progress, click [Install this driver software anyway] and continue with the installation.

When the installation program is completed, a completion message appears.

Installation procedure (Mac OS X)

Do not connect this unit and the computer until installation is completed.

- If any other programs are running on the computer, quit them.

1 Obtaining the driver software Double-click the file for Mac (DDJ-RZ_M_X.X.X.dmg) downloaded in

The [DDJ-RZ_AudioDriver] menu screen appears.

2 Double-click [DDJ-RZ_AudioDriver.pkg].

The driver installation screen appears.

3 Check the details on the screen and click [Continue Anyway].

4 When the end user license agreement appears, read *Software end user license agreement* carefully, then click [Continue Anyway].

5 If you consent to the provisions of the *Software end user license agreement*, click [Agree].

If you do not consent to the provisions of the *Software end user license agreement*, click [Disagree] and stop installation.

6 Proceed with installation according to the instructions on the screen.

Checking the latest information on the driver software

For the latest information on this unit's dedicated driver software, see the Pioneer DJ site below.

<http://www.pioneerdj.com/>

❖ Software end user license agreement

This Software End User License Agreement ("Agreement") is between you (both the individual installing the Program and any single legal entity for which the individual is acting) ("You" or "Your") and Pioneer DJ Corporation ("Pioneer DJ").

TAKING ANY STEP TO SET UP OR INSTALL THE PROGRAM MEANS THAT YOU ACCEPT ALL OF THE TERMS OF THIS LICENSE AGREEMENT. PERMISSION TO DOWNLOAD AND/OR USE THE PROGRAM IS EXPRESSLY CONDITIONED ON YOUR FOLLOWING THESE TERMS. WRITTEN OR ELECTRONIC APPROVAL IS NOT REQUIRED TO MAKE THIS AGREEMENT VALID AND ENFORCEABLE. IF YOU DO NOT AGREE TO ALL OF THE TERMS OF THIS AGREEMENT, YOU ARE NOT AUTHORIZED TO USE THE PROGRAM AND MUST STOP INSTALLING IT OR UNINSTALL IT, AS APPLICABLE.

1 DEFINITIONS

- 1 "Documentation" means written documentation, specifications and help content made generally available by Pioneer DJ to aid in installing and using the Program.
- 2 "Program" means all or any part of Pioneer DJ's software licensed to You by Pioneer DJ under this Agreement.

2 PROGRAM LICENSE

- 1 Limited License. Subject to this Agreement's restrictions, Pioneer DJ grants to You a limited, non-exclusive, non-transferable, license (without the right to sublicense):
 - a To install a single copy of the Program in Your computer or mobile device, to use the Program only for Your personal purpose complying with this Agreement and the Documentation ("Authorized Use");
 - b To use the Documentation in support of Your Authorized Use; and
 - c To make one copy of the Program solely for backup purposes, provided that all titles and trademark, copyright and restricted rights notices are reproduced on the copy.
- 2 Restrictions. You will not copy or use the Program or Documentation except as expressly permitted by this Agreement. You will not transfer, sublicense, rent, lease or lend the Program, or use it for third-party training, commercial time-sharing or service bureau use. You will not Yourself or through any third party modify, reverse engineer, disassemble or decompile the Program, except to the extent expressly permitted by applicable law, and then only after You have notified Pioneer DJ in writing of Your intended activities.
- 3 Ownership. Pioneer DJ or its licensor retains all right, title and interest in and to all patent, copyright, trademark, trade secret and other intellectual property rights in the Program and Documentation, and any derivative works thereof. You do not acquire any other rights, express or implied, beyond the limited license set forth in this Agreement.
- 4 No Support. Pioneer DJ has no obligation to provide support, maintenance, upgrades, modifications or new releases for the Program or Documentation under this Agreement.

3 WARRANTY DISCLAIMER

THE PROGRAM AND DOCUMENTATION ARE PROVIDED "AS IS" WITHOUT ANY REPRESENTATIONS OR WARRANTIES, AND YOU AGREE TO USE THEM AT YOUR SOLE RISK. TO THE FULLEST EXTENT PERMISSIBLE BY LAW, PIONEER DJ EXPRESSLY DISCLAIMS ALL WARRANTIES OF ANY KIND WITH RESPECT TO THE PROGRAM AND DOCUMENTATION, WHETHER EXPRESS, IMPLIED, STATUTORY, OR ARISING OUT OF COURSE OF PERFORMANCE, COURSE OF DEALING OR USAGE OF TRADE, INCLUDING ANY WARRANTIES OF MERCHANTABILITY, FITNESS FOR A PARTICULAR PURPOSE, SATISFACTORY QUALITY, ACCURACY, TITLE OR NON-INFRINGEMENT.

4 EXPORT CONTROL AND COMPLIANCE WITH LAWS AND REGULATIONS

You may not use or otherwise export or re-export the Program except as authorized by United States law and the laws of the jurisdiction in which the Program was obtained. In particular, but without limitation, the Program may not be exported or re-exported (a) into any U.S.-embargoed countries or (b) to anyone on the U.S. Treasury Department's Specially Designated Nationals List or the U.S. Department of Commerce Denied Persons List or Entity List. By using the Program, you represent and warrant that you are not located in any such country or on any such list. You also agree that you will not use the Program for any purposes prohibited by United States law, including, without limitation, the development, design, manufacture, or production of nuclear, missile, or chemical or biological weapons.

5 U.S. GOVERNMENT RESTRICTED RIGHTS

The Program and Documentations are "commercial computer software" and "commercial computer software documentation" as those terms are defined in 48 C.F.R. §252.227-7014 (a) (1) (2007) and 252.227-7014 (a) (5) (2007). The U.S. Government's rights with respect to the Program and Documentations are limited by this license pursuant to 48 C.F.R. §12.212 (Computer software) (1995) and 48 C.F.R. §12.211 (Technical data) (1995) and/or 48 C.F.R. §227.7202-3, as applicable.

As such, the Program and Documentations are being licensed to the U.S. Government end users: (a) only as "commercial items" as that term is defined in 48 C.F.R. §2.101 generally and as incorporated in DFAR 212.102; and (b) with only those limited rights as are granted to the public pursuant to this license. Under no circumstance will the U.S. Government or its end users be granted any greater rights than we grant to other users, as provided for in this license. Manufacturer is Pioneer DJ Corporation, 1-1 Shin-Ogura, Saiwai-ku, Kawasaki-shi, Kanagawa, 212-0031 Japan

6 DAMAGES AND REMEDIES FOR BREACH

You agree that any breach of this Agreement's restrictions would cause Pioneer DJ irreparable harm for which money damages alone would be inadequate. In addition to damages and any other remedies to which Pioneer DJ may be entitled, You agree that Pioneer DJ may seek injunctive relief to prevent the actual, threatened or continued breach of this Agreement.

7 TERMINATION

Pioneer DJ may terminate this Agreement at any time upon Your breach of any provision. If this Agreement is terminated, You will stop using the Program, permanently delete it from your computer or mobile device where it resides, and destroy all copies of the Program and Documentation in Your possession, confirming to Pioneer DJ in writing that You have done so. Sections 2.2, 2.3, 2.4, 3, 4, 5, 6, 7 and 8 will continue in effect after this Agreement's termination.

8 GENERAL TERMS

- 1 Limitation of Liability. In no event will Pioneer DJ or its subsidiaries be liable in connection with this Agreement or its subject matter, under any theory of liability, for any indirect, incidental, special, consequential or punitive damages, or damages for lost profits, revenue, business, savings, data, use, or cost of substitute procurement, even if advised of the possibility of such damages or if such damages are foreseeable. In no event will Pioneer DJ's liability for all damages exceed the amounts actually paid by You to Pioneer DJ or its subsidiaries for the Program. The parties acknowledge that the liability limits and risk allocation in this Agreement are reflected in the Program price and are essential elements of the bargain between the parties, without which Pioneer DJ would not have provided the Program or entered into this Agreement.
- 2 The limitations or exclusions of warranties and liability contained in this Agreement do not affect or prejudice Your statutory rights as consumer and shall apply to You only to the extent such limitations or exclusions are permitted under the laws of the jurisdiction where You are located.
- 3 Severability and Waiver. If any provision of this Agreement is held to be illegal, invalid or otherwise unenforceable, that provision will be enforced to the extent possible or, if incapable of enforcement, deemed to be severed and deleted from this Agreement, and the remainder will continue in full force and effect. The waiver by either party of any default or breach of this Agreement will not waive any other or subsequent default or breach.
- 4 No Assignment. You may not assign, sell, transfer, delegate or otherwise dispose of this Agreement or any rights or obligations under it, whether voluntarily or involuntarily, by operation of law or otherwise, without Pioneer DJ's prior written consent. Any purported assignment, transfer or delegation by You will be null and void. Subject to the foregoing, this Agreement will be binding upon and will inure to the benefit of the parties and their respective successors and assigns.
- 5 Entire Agreement. This Agreement constitutes the entire agreement between the parties and supersedes all prior or contemporaneous agreements or representations, whether written or oral, concerning its subject matter. This Agreement may not be modified or amended without Pioneer DJ's prior and express written consent, and no other act, document, usage or custom will be deemed to amend or modify this Agreement.
- 6 You agree that this Agreement shall be governed and construed by and under the laws of Japan.

Connections and part names

Connections

- Connect the power cord after all the connections between devices have been completed. Be sure to turn off the power and unplug the power cord from the power outlet whenever making or changing connections. Refer to the operating instructions for the component to be connected.
- Be sure to use the included power cord.
- Be sure to use the USB cable included with this product or the one that conforms to USB 2.0.

Names of Parts

❖ Rear panel

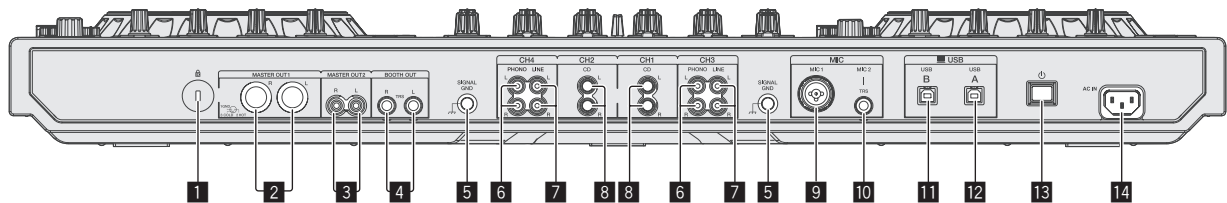

1 Kensington security slot

2 MASTER OUT 1 terminals

Connect powered speakers, etc., here.

- Compatible with XLR connector type balanced outputs.

3 MASTER OUT 2 terminals

Connect to a power amplifier, etc.

- Compatible with RCA pin-jack type unbalanced outputs.

4 BOOTH OUT terminals

Output terminals for a booth monitor, compatible with balanced or unbalanced output for a TRS connector.

The master channel sound can be output from the [BOOTH OUT] terminals regardless of the audio level set for the master channel.

The volume level can be adjusted with the [BOOTH MONITOR] control.

- The sound will be distorted if the level is raised too high when using unbalanced outputs.

5 SIGNAL GND terminal

Connects an analog player's ground wire here. This helps reduce noise when the analog player is connected.

6 PHONO terminals

Connect to a phono level (MM cartridge) output device. Do not input line level signals.

- You need to set the [LINE, PHONO, USB] selector switch on top of the unit to [PHONO] beforehand.

7 LINE terminals

Connect to a DJ player or other line level device.

- You need to set the [LINE, PHONO, USB] selector switch on top of the unit to [LINE] beforehand.

8 CD terminals

Connect to a DJ player or other line level device.

- You need to set the [CD, USB] selector switch on top of the unit to [CD] beforehand.

9 MIC1 terminal

Connects a microphone here.

- Either an XLR connector or a phones plug (Ø 6.3 mm) can be used.

10 MIC2 terminal

Connects a microphone here.

11 USB-B terminal

Connect to a computer.

- Connect this unit to your computer directly via a USB cable included with this product or the one that conforms to USB 2.0.
- A USB hub cannot be used.

12 USB-A terminal

Connect to a computer.

- Connect this unit to your computer directly via a USB cable included with this product or the one that conforms to USB 2.0.
- A USB hub cannot be used.

13 Power switch

This switches this unit's power between on and standby.

14 AC IN terminal

Connect the power cord after all the connections between devices have been completed.

Be sure to use the included power cord.

❖ Front panel

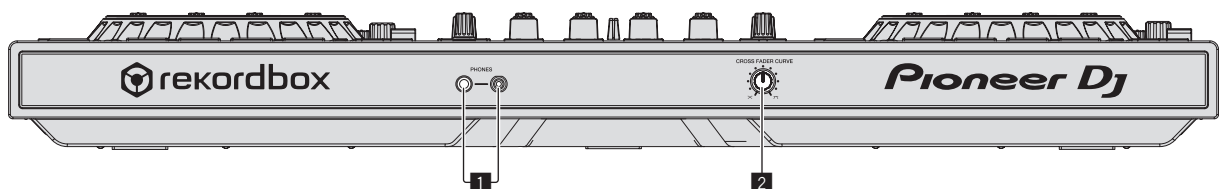

1 PHONES jacks

Connect headphones here.

Both stereo phone plugs (Ø 6.3 mm) and stereo mini phone plugs (Ø 3.5 mm) can be used.

- There are two input jacks, both a stereo phones jack and a mini phones jack, but do not use both simultaneously. If both are used simultaneously, when one is disconnected and/or connected, the volume of the other may increase or decrease suddenly.

2 CROSS FADER CURVE selector switch

This switches the crossfader curve characteristics.

- The further the control is turned clockwise, the sharper the curve rises.

- The further the control is turned counterclockwise, the more gradually the curve rises.

Part names and functions

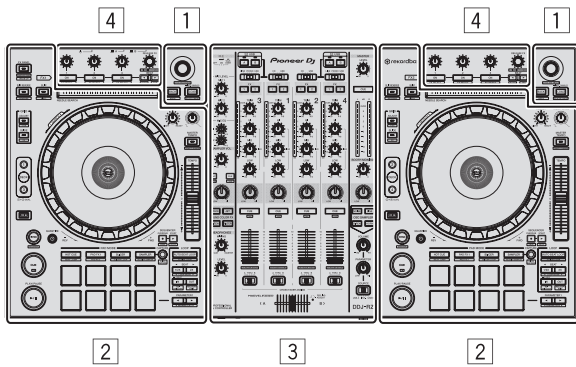

- 1 Browser section
- 2 Deck section
- 3 Mixer section
- 4 Effect section

Browser section

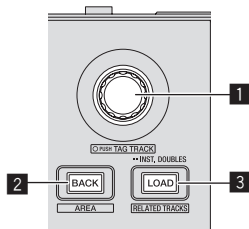

1 Rotary selector

Turn:
Moves the selection cursor in the DJ application.

[SHIFT] + turn:
Enlarges or reduces the enlarged waveform display of rekordbox dj.
Right turn enlarges the waveform display, and left turn reduces it.

Press:
Moves between the tree view area and track list area of rekordbox dj.
[Tree View] ⇒ [Track] list ⇒ [Tree View] ⇒ ...
• When [Tag List], [Palette bank1], and [Related Tracks] are displayed, also moves between these areas.

[SHIFT] + press:
Registers or unregisters the selected track to/from [Tag List].

2 BACK button

Press:
Moves between the tree view and track list or opens and closes a folder.

[SHIFT] + press:
Changes the display depending on the state in [rekordbox dj] as shown below.
No display ⇒ [Tag List] displayed ⇒ [Palette bank1] displayed ⇒ [Palette bank2] displayed ⇒ [Palette bank3] displayed ⇒ No display ⇒ ...
Also, when [Tag List] is displayed, the cursor moves to the [Tag List] area.

3 LOAD (RELATED TRACKS) button

Press:
Loads the selected track to the deck.

Press twice:
Loads the track loaded in the deck not being operated to the deck on the operation side.
The playback position is also loaded in the same state.

[SHIFT] + press:
Displays [Related Tracks] if hidden and hides it if displayed.
No display ⇒ [Related Tracks] displayed ⇒ No display ⇒ ...
Also, when [Related Tracks] is displayed, the cursor moves to the [Related Tracks] area.

Deck section

This section is used to control the four decks. The buttons and controls for operating decks 1 and 3 are located on the left side of the controller, those for operating decks 2 and 4 are located on the right side of the controller.

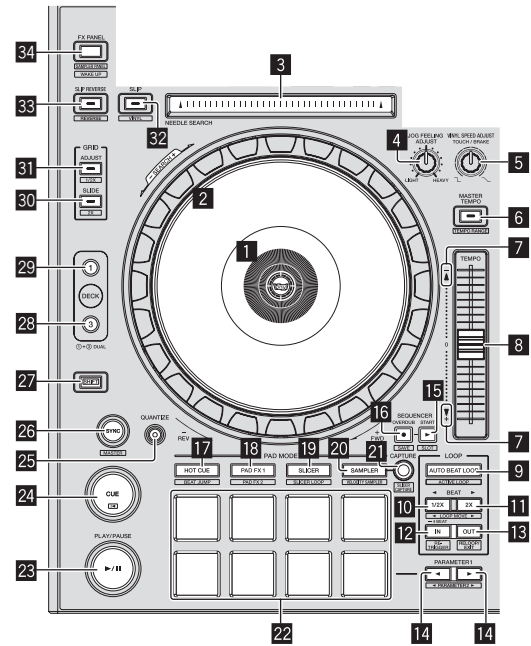

1 Jog dial display section

⇨ *Jog dial display section (p.12)*

2 Jog dial

Turn top when VINYL mode is on:
Performs scratching operation.

Turn outer section or turn top when VINYL mode is off:
The pitch bend operation (adjustment of the playing speed) is possible.

[SHIFT] + Turn top:
Fast-forwards or fast-reverses.

3 NEEDLE SEARCH pad

By touching the pad, you can jump to the desired playback position in the track loaded in the deck.

- In the environmental settings of rekordbox, you can set to enable to jump to the desired playback position during pause or anytime.

4 JOG FEELING ADJUST control

This adjusts the load applied when the jog dial is spun.
The load gets heavier when turned clockwise, lighter when turned counterclockwise.

5 VINYL SPEED ADJUST TOUCH/BREAK control

Adjusts the speed at which playback is slowed to the stopped state when the stop operation is performed during playback.

6 MASTER TEMPO button

Press:
Turns the master tempo function on or off.
When the master tempo function is on, the key does not change even when the playback speed is changed with the [TEMPO] slider.

[SHIFT] + press:
The [TEMPO] slider's range of variation switches each time the button is pressed.

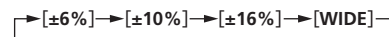

7 Takeover indicator

When decks are switched, the sync function is off, or the master is switched while synchronizing, the position of the controller's [TEMPO] slider may not match the software's tempo (pitch). To regain control of the tempo from the controller, adjust using the takeover indicator as reference. Slowly move the [TEMPO] slider in the direction in which the takeover indicator lights. When moved to the position at which the takeover indicator turns off, it matches the software's tempo (pitch) and the tempo can once again be controlled with the [TEMPO] slider.

8 TEMPO slider

Use this to adjust the track playing speed.

9 AUTO BEAT LOOP button

Press:
Turns manual loop and auto beat loop on or off.

[SHIFT] + press:
The loop registered in [rekordbox] can be set as the active loop.

Setting an active loop

- If pressing the [SHIFT] and [AUTO BEAT LOOP] buttons when a loop is registered in rekordbox and a track for which an active loop is not set is loaded, the closest loop in a clockwise direction can be set as an active loop.
- The function is invalid when a track which a loop is not registered to is loaded.

Canceling the active loop setting

- If pressing the [SHIFT] and [AUTO BEAT LOOP] buttons when a track for which an active loop is set is loaded, the set active loop can be canceled.

10 LOOP 1/2X button

Press:
Select the auto loop beat.
During loop playback, the length of loop playback is split in half each time this button is pressed.

[SHIFT] + press:
During loop playback, moves the loop to the left by the amount equal to its length. (Loop Move)

11 LOOP 2X button

Press:
Select the auto loop beat.
During loop playback, the loop length is doubled each time this button is pressed.

[SHIFT] + press:
During loop playback, moves the loop to the right by the amount equal to its length. (Loop Move)

12 LOOP IN button

Press:
Loop In Point is set.
When this button is pressed during loop playback, the loop in point can be fine-adjusted using the jog dial.

[SHIFT] + press:
Moves to the loop in point.

Press for over 1 second:
Starts 4-beat looping.

13 LOOP OUT button

Press:
The loop out point is set, and loop playback begins.
When this button is pressed during loop playback, the loop out point can be fine-adjusted using the jog dial.

[SHIFT] + press:
Cancels loop playback. (Loop Exit)
After loop playback is canceled, playback returns to the previously set loop in point and loop playback resumes. (Reloop)

14 PARAMETER◀ button, PARAMETER▶ button

These set the various parameters for when using the performance pads.
➔ *Using the performance pads* (p.16)

15 SEQUENCER START button

Press:
Starts playback of the recorded performance information (sequence).
When this button is pressed again during playback of a sequence, the playback pauses. When this button is pressed while recording a sequence, new sequence is overdubbed onto the sequence being played back.

16 SEQUENCER OVERDUB button

Press:
Turns the overdub function on.
Enters the standby state for recording and starts recording performance information when a pad is operated.

[SHIFT] + press:
Saves the recorded performance information to the sequencer.

17 HOT CUE mode button

Press:
Sets the hot cue mode.
➔ *Using hot cues* (p.16)

[SHIFT] + press:
Sets the beat jump mode.
➔ *Using beat jump* (p.16)

18 PAD FX1 mode button

Press:
Sets the pad FX1 mode.
➔ *Using the pad FX* (p. 16)

[SHIFT] + press:
Sets the pad FX2 mode.
➔ *Using the pad FX* (p. 16)

19 SLICER mode button

Press:
Sets the slicer mode.
➔ *Using the Slicer function* (p. 16)

[SHIFT] + press:
Sets the slicer loop mode.
➔ *Using the Slicer function* (p. 16)

20 SAMPLER mode button

Press:
Sets the sampler mode.
➔ *Using the sampler function* (p. 17)

[SHIFT] + press:
Sets the velocity sampler mode.
➔ *Using the velocity sampler* (p.18)

21 CAPTURE button

Press:
Registers the loop being played to the sampler pad.
• This is enabled when looping is in a set state.

[SHIFT] + press:
Loads the sections in the target area of slicer or slicer loop to separate sampler slots.
• This is enabled in slicer mode or slicerUsing effects in the multi FX mod loop mode.
• For detailed instructions on slicer and slicer loop, see the rekordbox software's manual.

22 Performance pads

Various performances can be achieved using the pads.
➔ *Using the performance pads* (p.16)

23 PLAY/PAUSE ▶/II button

Press:
Use this to play/pause tracks.

24 CUE button

Press:
Sets, plays and calls out cue points.
• When the [CUE] button is pressed during pause, the cue point is set.
• When the [CUE] button is pressed during playback, the track returns to the cue point and pauses. (Back Cue)
• When the [CUE] button is pressed and held after the track returns to the cue point, playback continues as long as the button is pressed. (Cue Sampler)

[SHIFT] + press:
Returns to the beginning of the track.

25 QUANTIZE button

Turns quantize on or off.

26 SYNC button

Press:
Switches between synchronizing and not synchronizing (SYNC ON/OFF) to the tempo of the master deck.

[SHIFT] + press:
Use this to set the track loaded in this unit as the master for the beat sync function.

27 SHIFT button

When another button is pressed while pressing the [SHIFT] button, a different function is called out.

28 DECK 3 button

Switches the deck to be operated to deck 3.

29 DECK 1 button

Switches the deck to be operated to deck 1.

30 GRID SLIDE button

Press:
When the jog dial is turned while pressing the [GRID SLIDE] button, the overall beat grid can be slid to the left or right.

[SHIFT] + press:
Doubles the interval for beat grids.

31 GRID ADJUST button

Press:
When the jog dial is turned while pressing the [GRID ADJUST] button, the beat grid interval can be adjusted.

[SHIFT] + press:
Halves the interval for beat grids.

32 SLIP button

Press:
Turns the slip mode on and off.
➡ *Using the slip mode* (p.18)

[SHIFT] + press:
This switches the vinyl mode on/off.

33 SLIP REVERSE button

Press:
Performs reverse playback only while pressed.
Slip reverse play is automatically canceled after 8 beats have elapsed even if the [SLIP REVERSE] button is kept pressed. The playback returns to normal after reverting to the background.

[SHIFT] + press:
Switches between forward playback and reverse playback.

34 FX PANEL button

Press:
(During normal operation)
Switches [FX] panel display.
(During standby status)
The standby mode is canceled.

[SHIFT] + press:
Displays or hides [SAMPLER] panel display.

Mixer section

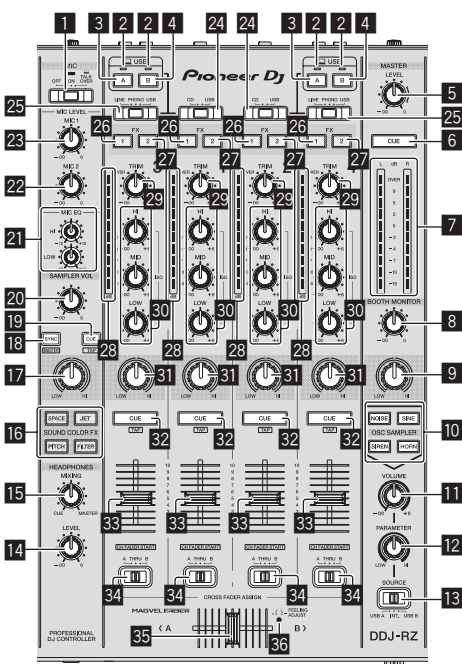

1 OFF, ON, TALK OVER selector switch

Turns the microphone on/off.

2 USB connection indicator

Displays the connection status between the **USB-A** terminal and **USB-B** terminal.
Lights: When the computer is connected to the terminal and the driver is installed
Flashes: When the computer is connected to the terminal and the driver is not installed
Lights out: When the computer is not connected to the terminal

3 USB (A) button

When lights, the **USB-A** terminal is used in communication with the computer.

- The [USB (A)] button and [USB (B)] button located at the left side are used to control the USB communication for deck 1 or deck 3. The [USB (A)] button and [USB (B)] button located at the right side are used to control USB communication for deck 2 or deck 4.
- When the [USB (A)] button or [USB (B)] button located on the left side is flashing, it means the deck 1 or deck 3 audio is on air. Flashing stops when the channel fader of deck 1 or deck 3 is moved to the frontmost position. When the [USB (A)] button or [USB (B)] button located on the right side is flashing, it means deck 2 or deck 4 audio is on air. Flashing stops when the channel fader of deck 2 or deck 4 is moved to the frontmost position. (When the USB terminal is switched, sound is also switched instantaneously. Therefore, when the button is flashing, before switching the USB terminal, make sure that the deck is not used by another user.)

4 USB (B) button

When lights, the **USB-B** terminal is used in communication with the computer.

- The [USB (A)] button and [USB (B)] button located at the left side are used to control the USB communication for deck 1 or deck 3. The [USB (A)] button and [USB (B)] button located at the right side are used to control USB communication for deck 2 or deck 4.
- When the [USB (A)] button or [USB (B)] button located on the left side is flashing, it means the deck 1 or deck 3 audio is on air. Flashing stops when the channel fader of deck 1 or deck 3 is moved to the frontmost position. When the [USB (A)] button or [USB (B)] button located on the right side is flashing, it means deck 2 or deck 4 audio is on air. Flashing stops when the channel fader of deck 2 or deck 4 is moved to the frontmost position. (When the USB terminal is switched, sound is also switched instantaneously. Therefore, when the button is flashing, before switching the USB terminal, make sure that the deck is not used by another user.)

5 MASTER LEVEL control

Adjusts the master sound level output.

6 MASTER CUE button

Turns monitoring of the master output's sound on and off.

7 Master level indicator

Displays the master output's audio level.

8 BOOTH MONITOR control

Adjusts the level of audio signals output from the [BOOTH OUT] terminal.

9 MASTER OUT COLOR control

Changes the SOUND COLOR FX parameter applied to the master output sound.

10 OSC SAMPLER SELECT button

Generates oscillator sound (NOISE, SINE, SIREN, and HORN).
➡ *Using the oscillator function* (p.22)

11 OSC SAMPLER VOLUME control

Adjusts the sound level of oscillator sound.

12 OSC SAMPLER PARAMETER control

Adjusts the quantitative parameters of oscillator sound.

13 SOURCE selector switch

Selects the oscillator sound source.

14 HEADPHONES LEVEL control

Adjusts the sound level output from the headphones.

15 HEADPHONES MIXING control

Adjusts the balance of the monitor volume between the sound of the channels for which the headphones [CUE] button is pressed and the sound of the master channel.

16 SOUND COLOR FX buttons

These turn the SOUND COLOR FX effects on/off.

17 MIC COLOR control

Changes the parameter of SOUND COLOR FX applied to microphone sound or sampler sound.

18 SAMPLER SYNC button

Press:
Switches between synchronizing and not synchronizing (SYNC ON/OFF) the sampler sound to the tempo of the master deck.

[SHIFT] + press:
Sets the sampler sound source as the master for the beat sync function.

19 SAMPLER CUE button

Press:
Turns monitoring of the sampler sound on or off.

[SHIFT] + press:
Calculates the BPM value used as the base for the sampler from the interval at which the button is tapped with a finger. (Tap function)

20 SAMPLER VOLUME control

Adjusts the sound level of sampler.

21 EQ (HI, LOW) controls

These adjust the tone quality of the [MIC1] and [MIC2] channels.

22 MIC2 control

Adjusts the sound level output from the [MIC2] channel.

23 MIC1 control

Adjusts the sound level output from the [MIC1] channel.

24 CD, USB selector switch

Selects the input source of each channel from the components connected to this unit.

- [CD]: Select this to use a line level output device (DJ player, etc.) connected to the [CD] terminals.
- [USB]: Select this to use the track loaded in the rekordbox dj deck.

25 LINE, PHONO, USB selector switch

Selects the input source of each channel from the components connected to this unit.

- [LINE]: Select this to use a line level output device (DJ player, etc.) connected to the [LINE] input terminals.
— When [PHONO] is selected, sound is muted momentarily.
- [PHONO]: Select this to use a phono level (for MM cartridges) output device (analog player, etc.) connected to the [PHONO] input terminals.
- [USB]: Select this to use the track loaded in the rekordbox dj deck.

26 FX 1 assign button

Turns effect unit FX1 on and off for the respective channel.

27 FX 2 assign button

Turns effect unit FX2 on and off for the respective channel.

28 Channel Level Indicator

Displays the sound level of the respective channels before passing through the channel faders.

29 TRIM control

Adjusts the level of audio signals input in each channel.

30 ISO (HI, MID, LOW) controls

Boosts or cuts frequencies for the different channels.

31 COLOR control

This changes the parameters of the SOUND COLOR FX of the different channels.

32 Headphones CUE button

Press:

The sound of channels for which the headphones [CUE] button is pressed is output to the headphones.

- When the headphones [CUE] button is pressed again, monitoring is canceled.

[SHIFT] + press:

The track's tempo can be set by tapping the button. (Tap function)

33 Channel fader

Move:

Adjusts the level of audio signals output in each channel.

[SHIFT] + move:

Use the channel fader start function.

➔ *Using the channel fader start function* (p.19)

34 Crossfader assign selector switch

Assigns the channel output to the crossfader.

[A]: Assigns to [A] (left) of the crossfader.

[B]: Assigns to [B] (right) of the crossfader.

[THRU]: Selects this when you do not want to use the crossfader. (The signals do not pass through the crossfader.)

35 Crossfader

Outputs the sound assigned with the crossfader assign switch.

[SHIFT] + move:

Uses the crossfader start function.

➔ *Using the crossfader start function* (p.20)

36 FEELING ADJUST adjustment hole

This can be used to adjust the crossfader's operating load.

➔ *Adjusting the crossfader's operating load* (p.20)

Effect section

This section is used to control the two effect units (FX1 and FX2). Controls and buttons used to operate the FX1 unit are located on the left side of the controller, those used to operate the FX2 unit are located on the right side of the controller. The channels to which the effect is to be applied are set using the effect assign buttons on the mixer.

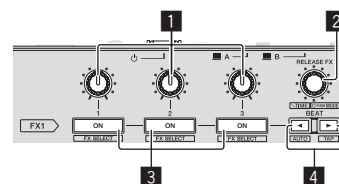
**1 Effect parameter controls**

Adjusts the beat FX parameter.

2 RELEASE FX control

Turn:

Selects the release FX type.

Press:

Enables release FX only while pressed. If the release FX turns on, the beat FX in the same effect unit turns off.

[SHIFT] + turn:

Adjusts the beat FX time.

[SHIFT] + press:

Switches the beat FX mode.

3 Effect parameter buttons

Press:

Turns the beat FX on and off or switches the parameters.

[SHIFT] + press:

Switches the effect type.

4 BEAT ◀ button, BEAT ▶ button

BEAT ◀ button

Press:

Reduces the beat interval for applying beat FX.

[SHIFT] + press:

Returns the tempo of beat FX to BPM of the deck.

BEAT ▶ button

Press:

Increases the beat interval for applying beat FX.

[SHIFT] + press:

Calculates the BPM value used as the base for beat FX from the interval at which the button is tapped with a finger. (Tap function)

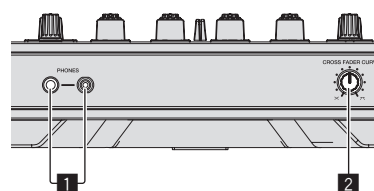
Front panel**1 PHONES jacks****2 CROSS FADER CURVE selector switch**

This switches the crossfader curve characteristics.

- The further the control is turned clockwise, the sharper the curve rises.
- The further the control is turned counterclockwise, the more gradually the curve rises.

Jog dial display section

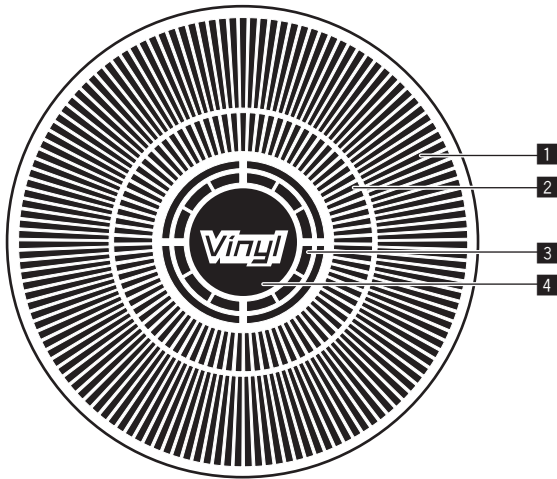

1 Operation display

This works in synchronization with the rotation display of the rekordbox dj deck.

2 Cue point display

Displays the cue point.

- You can switch between the current cue display and hot cue countdown display in the environment settings of rekordbox.

3 Jog touch detection display

The display lights when the jog dial top is pressed when VINYL mode is on.

4 VINYL

The display lights when VINYL mode is on.

Basic Operation

Connecting this unit and computer

1 Connect headphones to one of the [PHONES] terminals.

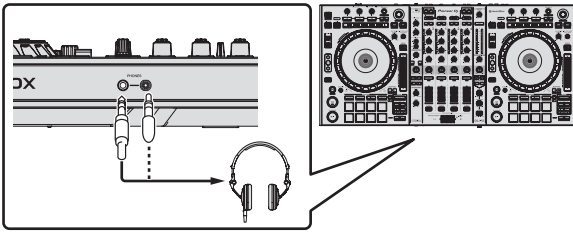

2 Connect powered speakers, a power amplifier, components, etc., to the [MASTER OUT 1] or [MASTER OUT 2] terminals.

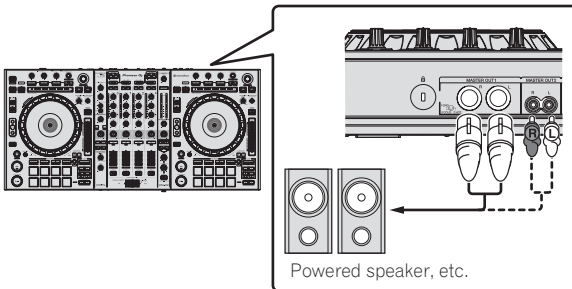

- To output the sound from the [BOOTH OUT] terminals, connect speakers or other devices to the [BOOTH OUT] terminals.
- For details on the connections of the input/output terminals, see *Connections* (p.6).

3 Connect this unit to your computer via a USB cable.

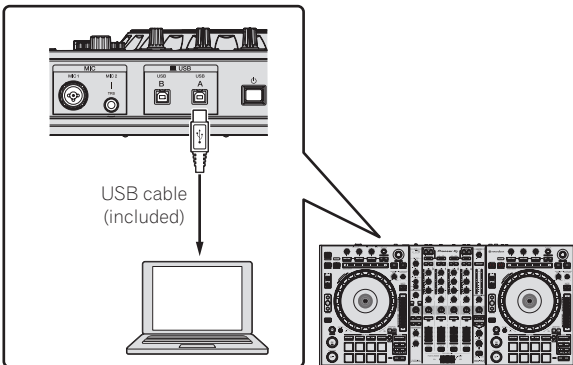

This product satisfies electromagnetic noise regulations when it is connected to other equipment through shielded cables and connectors. Use only the furnished accessory connecting cables.

D44-8-2_A1_En

4 Turn on the computer's power.

5 Connect the power cord.

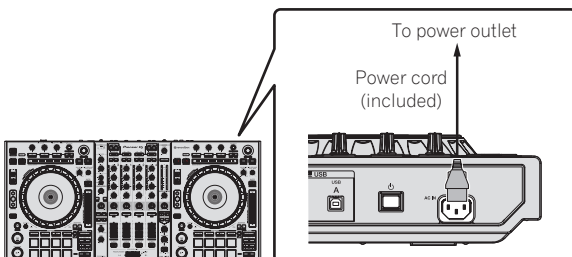

6 Press the [⏻] switch on this unit's rear panel to turn this unit's power on.

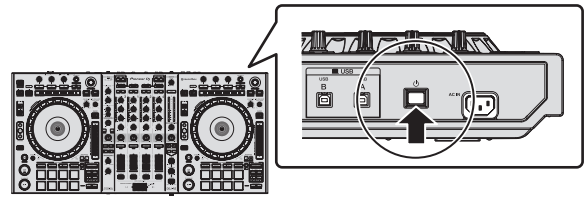

Turn on the power of this unit.

- For Windows users
The message [Installing device driver software] may appear when this unit is first connected to the computer or when it is connected to a different USB port on the computer. Wait a while until the message [Your devices are ready for use] appears.

7 Turn on the power of the devices connected to the output terminals (powered speakers, power amplifier, components, etc.).

- When a microphone, DJ player or other external device is connected to input terminals, the power of that device also turns on.

Starting the system

Launching rekordbox

For Windows 7

Click the [All Programs] > [Pioneer] > [rekordbox] icon from the Windows [Start] menu.

For Windows 8.1/8

From [Apps view], click the [rekordbox] icon.

For Mac OS X

Open the [Applications] folder in Finder, then double-click the [rekordbox] icon.

Adding music files to Collection

"Collection" is a list of all the tracks managed by rekordbox.

The music files on the computer can be used with rekordbox if they are analyzed and then registered as rekordbox music collection files.



a Tree View

b Track list

1 Click [Collection] in the tree view.

The [Collection] music files are displayed in the track list.

2 Open Finder or Windows explorer, then drag and drop music files or folders including music files to the track list.

The music files are added to the [Collection] and the tag information of the music files is read and then displayed.

This manual consists mainly of explanations of functions of this unit as hardware. For detailed instructions on operating rekordbox dj, see the rekordbox software's manual.

Loading tracks and playing them

The following describes the procedure for loading tracks onto deck 1 as an example.

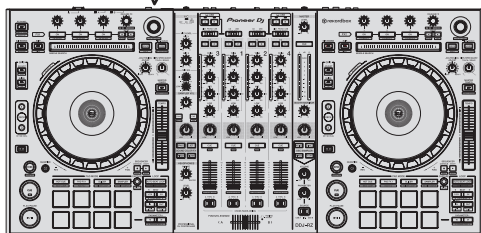
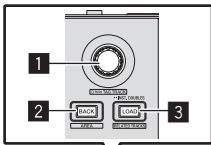

1 Rotary selector

2 BACK button

3 LOAD button

1 Select the [Collection] or a playlist or other item and then press the unit's rotary selector to move to the track list.

2 Turn the rotary selector and select the track.

3 Press the [DECK1] button.

4 Press the [LOAD] button to load the selected track onto the deck.

Playing tracks and outputting the sound

The following describes the procedure for outputting the channel 1 sound as an example.

- Set the volume of the devices (power amplifier, powered speakers, etc.) connected to the [MASTER OUT 1] and [MASTER OUT 2] terminals to an appropriate level. Note that loud sound will be output if the volume is set too high.

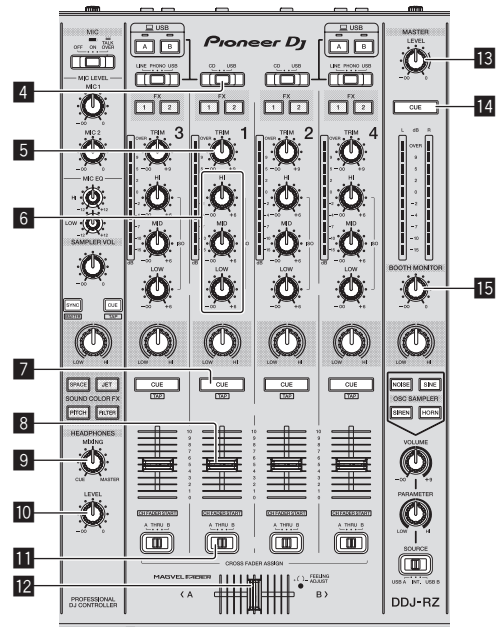

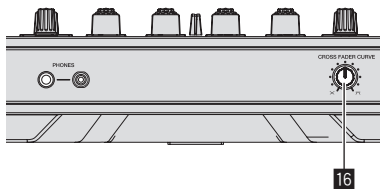

- 4 CD, USB selector switch
- 5 TRIM control
- 6 ISO (HI, MID, LOW) controls
- 7 Headphones CUE button
- 8 Channel fader
- 9 HEADPHONES MIXING control
- 10 HEADPHONES LEVEL control
- 11 Crossfader assign selector switch
- 12 Crossfader
- 13 MASTER LEVEL control
- 14 MASTER CUE button
- 15 BOOTH MONITOR control
- 16 CROSS FADER CURVE control

1 Set the positions of the controls, etc., as shown below.

Names of controls, etc.	Position
MASTER LEVEL control	Turned fully counterclockwise
CD, USB selector switch	[USB] position
TRIM control	Turned fully counterclockwise
ISO (HI, MID, LOW) controls	Center
Channel fader	Moved forward
Crossfader assign selector switch	[THRU] position

2 Press the [▶/II] button to play the track.

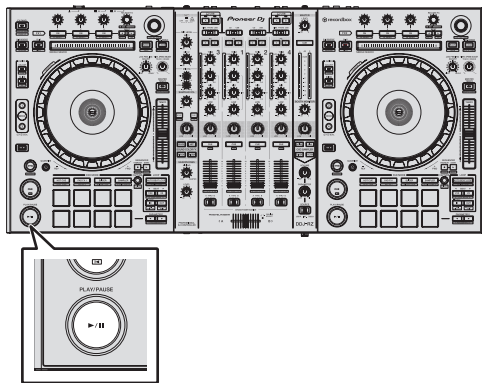

3 Turn the [TRIM] control.

Adjust the [TRIM] control so that the channel level indicator's orange indicator lights at peak level.

4 Move the channel fader away from you.

5 Turn the [MASTER LEVEL] control to adjust the audio level of the speakers.

Adjust the sound level output from the [MASTER OUT 1] and [MASTER OUT 2] terminals to an appropriate level.

Monitoring sound with headphones

Set the positions of the controls, etc., as shown below.

Names of controls, etc.	Position
HEADPHONES MIXING control	Center
HEADPHONES LEVEL control	Turned fully counterclockwise

1 Press the headphones [CUE] button for the channel 1.

2 Turn the [HEADPHONES LEVEL] control.

Adjust the sound level output from the headphones to an appropriate level.

Note

This unit and rekordbox dj include many functions to allow for more individualistic DJ performances. For details on each function, see the rekordbox software's manual.

- The rekordbox software's manual can be downloaded from rekordbox.com. For details, see *Downloading the rekordbox software manual* (p.29).

Quitting the system

1 Quit rekordbox.

2 Press the [⏻] switch on this unit's rear panel to set this unit's power to standby.

3 Disconnect the USB cable from your computer.

Advanced Operation

Using the performance pads

Use the performance pads with the hot cue, beat jump, pad FX, slicer, sampler, and velocity sampler functions.
The function of the performance pads can be switched with the pad mode buttons.

Using hot cues

This function allows playback to be started instantaneously from the position at which a hot cue or hot loop is set.

- Up to eight hot cue points or hot loop points can be set and saved per track.

1 Press the [HOT CUE] mode button.

Switches to hot cue mode.

2 In the play or pause mode, press a performance pad to set the hot cue point.

The hot cue points are assigned to the respective performance pads as shown below.

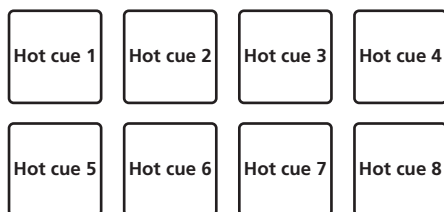

A hot loop can be assigned to a performance pad by pressing the pad during loop playback.

3 Press the performance pad with the hot cue point or hot loop point set.

Playback starts from the hot cue point or hot loop point.

- Set hot cue points can be cleared by pressing a performance pad while pressing the [SHIFT] button.

Using beat jump

The playback position can be moved instantaneously without breaking the rhythm of the track being played back.

1 Press the [HOT CUE] mode button while pressing the [SHIFT] button.

The mode switches to the beat jump mode.

2 Press the [PARAMETER◀] or [PARAMETER▶] button.

The movement amount (number of beats or number of bars) of the playback position assigned to the performance pad changes each time a button is pressed.

The following nine settings can be made.

page1	FINE/1/8 beat/1/4 beat/1/2 beat
page2	1/8 beat/1/4 beat/1/2 beat/1 beat
page3	1/4 beat/1/2 beat/1 beat/2 beats
page4	1/2 beat/1 beat/2 beats/4 beats
page5	1 beat/2 beats/4 beats/8 beats
page6	2 beat/4 beats/8 beats/16 beats
page7	4 beats/8 beats/16 beats/8 bars
page8	8 beats/16 beats/8 bars/16 bars
page9	16 beats/8 bars/16 bars/32 bars

For example, when set to "1 beats from 1/8 beat", the pad's setting is as shown below.



- If a button is pressed while pressing [SHIFT], only [page1], [page5], and [page9] can be selected.

3 Press pad 1, pad 3, pad 5, or pad 7.

The playback position moves in the reverse direction by the number of beats or number of bars assigned to the pad that was pressed.

4 Press pad 2, pad 4, pad 6, or pad 8.

The playback position moves in the forward direction by the number of beats or number of bars assigned to the pad that was pressed.

Using the pad FX

A wide range of effect performances are possible with just the simple operation of pressing and releasing performance pads.

1 Press the [PAD FX1] mode button.

The mode switches to pad FX mode 1.

By default, effects are assigned to the performance pads as shown below.

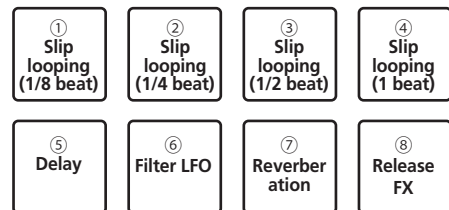

- If the [PAD FX1] mode button is pressed while pressing the [SHIFT] button, the mode changes to FX mode 2.

By default, effects are assigned to the performance pads as shown below.

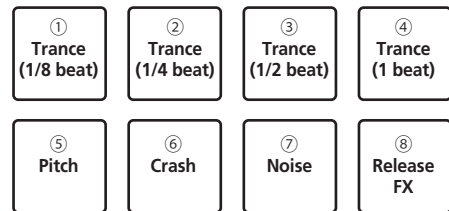

- The effects assigned to performance pads can be customized. For details, see the rekordbox software's manual.
- The type of release FX assigned to pad 8 cannot be changed by turning the unit's [RELEASE FX] control. To change the type of release FX assigned to pad 8, you need to make the change in rekordbox dj. For details, see the rekordbox software's manual.

2 Press and hold one of the performance pads.

The effect turns on according to the effect and number of beats settings assigned to the pad that was pressed.

3 Press the [PARAMETER◀] button or [PARAMETER▶] button while pressing the performance pad.

The number of beats setting for the effect temporarily increases or decreases.

- Depending on the type of effect, changing the setting may not be possible even by pressing the button.

4 Release your finger from the performance pad.

The effect turns off.

❖ Using the release FX of the pad FX

1 Press and hold one of performance pads 1 to 7.

The effect turns on according to the effect and number of beats settings assigned to the pad that was pressed.

2 Press performance pad 8.

The pad FX effect that was on up until now turns off and the release FX effect is added.

Using the Slicer function

The specified range is divided into eight equal sections, and these eight sliced sections are assigned to the respective performance pads. While one of the performance pads is pressed, the sound for the section assigned to that pad is played in a loop.

During loop playback of the pad's sound, normal playback with the original rhythm continues in the background. When the pad is released and loop playback ends, playback resumes from the position reached at that point.

- The slicer function cannot be used with tracks for which no beatgrid is set. For details on setting beatgrids, see the rekordbox software manual.
 - Beatgrids can also be set using this unit's [GRID ADJUST] and [GRID SLIDE] buttons. (p.10)

1 Press the [SLICER] mode button.

Switches to slicer mode.

- While pressing the [SHIFT] button, pressing the [SLICER] mode button switches the mode to slicer loop mode.
- For details, see *About slicer mode and slicer loop mode* on page 17.

2 Press the [PARAMETER◀] or [PARAMETER▶] button while pressing the [SHIFT] button.

Set the slicer range. The slicer range changes each time a button is pressed while pressing the [SHIFT] button.

Each of the sections resulting from dividing the slicer range into eight is assigned to the respective performance pad as shown below.

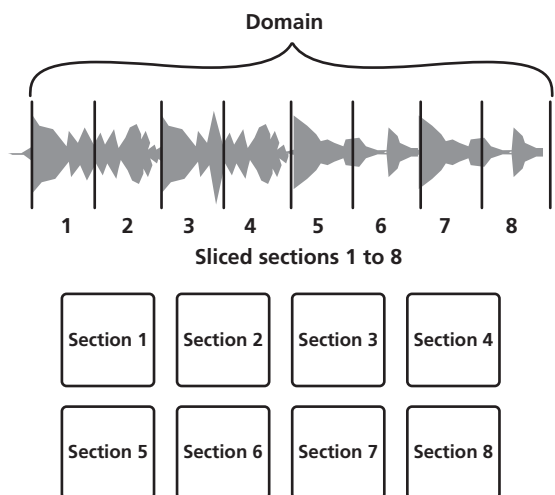

3 Press the [PARAMETER◀] or [PARAMETER▶] button.

Set the loop playback length for the slicer. The setting value for the loop playback length changes each time the button is pressed.

The length of loop playback while a pad is pressed can be changed with the loop playback length setting. For example, when the loop playback length is set to "1", the entire section assigned to the pad is played in a loop, and when the loop playback length is set to "1/2", only the first half of the section assigned to the pad is played in a loop.

4 Press and hold one of the performance pads.

When the pad is pressed and held, the sound is played in a loop. When the pad is released, the track returns to the position that is playing in the background.

❖ About slicer mode and slicer loop mode

Slicer mode

When the playback position advances to the end of the range that has been sliced into eight equal sections, the range shown on the display switches to the next eight sliced sections, and these sliced sections are assigned to the respective pads, replacing the previously assigned sections.

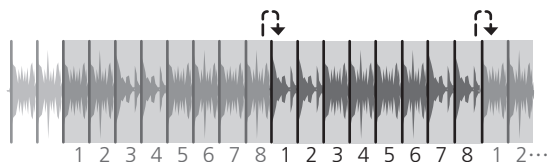

Slicer loop mode

When the playback position advances to the end of the range that was sliced into eight equal parts, the playback position returns to the beginning of the range that was sliced into eight equal parts.

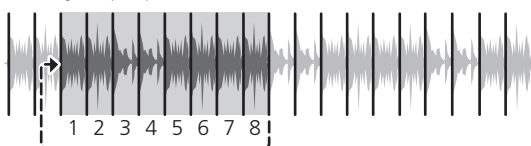

Using the sampler function

This procedure can be used to play tracks loaded in the sampler's sampler slots using the performance pads.

❖ Preparing to use the sampler

Press the [FX PANEL] button while pressing the [SHIFT] button.

The sampler panel appears on the rekordbox dj screen.

A track, loop, and slicer target area can be loaded in sampler slots.

❖ Load the track in a sampler slot.

1 Press the [SAMPLER] mode button.

Switches to the sampler mode.

2 Press the rotary selector or [BACK] button to move the cursor to the track list.

3 Turn the rotary selector.

Select the track you wish to load in a sampler slot.

4 Press the performance pad while pressing the [SHIFT] button.

The selected track is loaded into the sample slot.

- Loading by overwriting an already loaded sampler slot may not be possible depending on the preferences of rekordbox.

❖ Loading a loop in a sampler slot.

1 Press the [AUTO BEAT LOOP] button or [LOOP IN] button and then press the [LOOP OUT] button.

Loop playback starts.

2 Press a performance pad while pressing the [CAPTURE] button.

The pad mode is temporarily switched to the sampler mode and the loop is loaded in a sampler slot.

- Loading by overwriting an already loaded sampler slot may not be possible depending on the preferences of rekordbox.

❖ Loading the slicer target area in sampler slots

1 Press the [SLICER] mode button while pressing the [SHIFT] button.

The mode switches to the slicer loop mode.

- Alternatively, press the [SLICER] mode button to switch to the slicer mode.

2 Press the [CAPTURE] button while pressing the [SHIFT] button.

Each of the sections of the slicer target area is loaded in a separate sampler slot.

- With the default settings of rekordbox, the slicer target area is loaded in sampler bank 4. If there is even one sampler slot already loaded in sampler bank 4, loading may not be possible.

❖ Using the performance pads to play the sampler

1 Press the [SAMPLER] mode button.

Switches to the sampler mode.

2 Press the [PARAMETER◀] or [PARAMETER▶] button.

The sampler bank is switched. The sampler has four banks and each bank has sixteen slots.

3 Turn the [SAMPLER VOLUME] control clockwise.

4 Press a performance pad.

The sound for the slot assigned to the pad that was pressed is played.

- When the pad mode of deck 1 or deck 3 is the sampler mode (the slots in parentheses are when the pad mode of deck 2 or deck 4 is the sampler mode)

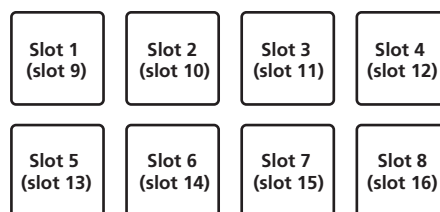

5 During playback, press a performance pad.

Playback continues by returning to the beginning.

6 Press a performance pad while pressing the [SHIFT] button during playback.

The sound of the slot that is currently playing stops.

Using the velocity sampler

In the velocity sampler mode, the sample volume level changes according to the amount of force used to tap the performance pads. The volume level increases when the performance pads are tapped strongly and decreases when they are tapped weakly.

❖ Switching to the velocity sampler mode

When the [SAMPLER] mode button is pressed while pressing the [SHIFT] button, the mode switches to the velocity sampler mode.

When the [SAMPLER] mode button is pressed, the mode switches to the normal sampler mode.

- The velocity curve can be set in the utilities mode.
For details, see *Changing the velocity curve setting of velocity sampler mode* on page 25.

Using the sequencer

Sampler performances can be recorded and played back.

The sequencer function can be used to achieve a variety of performances, such as superimposing an original rhythm loop or vocal loop created in advance on the track that is playing or changing the arrangement of an impromptu finger drum performance by adding sound using the overdub recording function or removing and adding sound using the mute function.

The following explains the basic operations of the sequencer. For sequencer application examples, see the rekordbox software's manual.

❖ Preparing to use the sequencer

1 Press the [FX PANEL] button while pressing the [SHIFT] button.

The sampler panel appears on the rekordbox dj screen.

2 Press the [SAMPLER] mode button.

The unit's pad mode switches to the sampler mode.

❖ Recording a sequence

1 Press the [PARAMETER◀] or [PARAMETER▶] button.

Select the bank of the sampler to be used for the performance.

2 Click the part indicated as [1 Bar] on the sampler panel of rekordbox dj.

Select a length for recording the sequence from 1 bar, 2 bars, and 4 bars in the pull-down menu that appears.

3 Press the [SEQUENCER OVERDUB] button.

The sequencer switches to the recording standby state.

4 Create a performance using the performance pads.

Recording of the sequence begins.

- Only a sampler slot with the PLAY mode of the sampler set to [One Shot] can record a sequence.
- When [QUANTIZE] of the sampler panel is on, the operation timing of the performance pads is quantized and the sequence is recorded.

5 Press the [SEQUENCER OVERDUB] button while pressing the [SHIFT] button.

The recorded sequence is saved.

❖ Calling out and playing a saved sequence

1 Press the [SEQUENCER START] button while pressing the [SHIFT] button.

Select the sequence you wish to call out.

2 Press the [SEQUENCER START] button.

The sequence plays.

- If the [SEQUENCER START] button is pressed again, the sequence stops.

❖ Using the sequence mute mode

In the sequence mute mode, you can control mute for each sampler slot with a performance pad.

This enables you to remove and add a kick, snare, or other drum sound to change the arrangement for a rhythm loop created with the sequencer.

1 Call out and play a sequence.

Calling out and playing a saved sequence (p. 18)

2 Press and hold the [PARAMETER◀] button.

rekordbox dj remains in the sequence mute mode while the [PARAMETER◀] button is pressed.

- If the [PARAMETER◀] button is released, the sequence mute mode is canceled.

3 Press a performance pad.

The sound of the slot assigned to the pad that was pressed is muted.

- If the same pad is pressed again, mute is canceled.

❖ Using the sequence erase mode

In the sequence erase mode, you can erase sequences on a sampler slot basis.

1 Call out and play a sequence.

Calling out and playing a saved sequence (p. 18)

2 Press and hold the [PARAMETER▶] button.

rekordbox dj remains in the sequence erase mode while the [PARAMETER▶] button is pressed.

- If the [PARAMETER▶] button is released, the sequence erase mode is canceled.

3 Press a performance pad.

The sequence of only the slot assigned to the pad that was pressed is erased.

Calling out cue points

A cue point or loop point that was saved in rekordbox dj can be called out.

1 Press the [HOT CUE] mode button.

2 Press the [PARAMETER◀] or [PARAMETER▶] button.

If you wish to call out a cue point that is before the current playback position, press the [PARAMETER◀] button.

If you wish to call out a cue point that is after the current playback position, press the [PARAMETER▶] button.

The track cues to the called out point and pauses.

Using the slip mode

When the slip mode is turned on, normal playback with the original rhythm continues in the background during scratching, looping and hot cue playback. When scratching, looping or hot cue playback is canceled, normal playback resumes from the position reached up to the point at which the operation was canceled.

Various performances can be achieved without breaking the rhythm.

- The [SLIP] button lights when the slip mode is set and flashes while the sound is being played in the background.

Slip scratching

1 While pressing the [SHIFT] button, press the [SLIP] button.

The unit switches to VINYL mode.

2 During playback, operate the top of the jog dial to scratch.

Normal playback continues in the background even while scratching.

3 Release your hand from the top of the jog dial.

Playback starts from the position reached in the background.

- To cancel the slip mode, press the [SLIP] button again.

Slip hot cue

1 Press the [HOT CUE] mode button.

Set the hot cue mode.

2 Set the hot cue.

Press a performance pad to set the hot cue.

3 Press the [SLIP] button.

The mode switches to the slip mode.

4 During playback, press and hold a performance pad.

Playback starts from the position at which the hot cue was set. Playback continues as long as the performance pad is pressed.

Normal playback continues in the background while the hot cue is playing.

5 Release your finger from the performance pad.

Playback starts from the position reached in the background.

- To cancel the slip mode, press the [SLIP] button again.

Slip braking

1 Adjust the [VINYL SPEED ADJUST] control.

The **VINYL SPEED ADJUST** setting adjusts the speed, etc. at which the track stops from the play mode.

2 Press the [SLIP] button.

The mode switches to the slip mode.

3 During playback, press the [PLAY/PAUSE ►/II] button.

Playback slowly stops while the button is being pressed. Normal playback continues in the background while playback is slowly stopping.

4 Press the [PLAY/PAUSE ►/II] button again.

Playback starts from the position reached in the background.

- To cancel the slip mode, press the [SLIP] button again.

Slip auto beat loop

1 Press the [SLIP] button.

The mode switches to the slip mode.

2 Press the [LOOP 1/2X] or [LOOP 2X] button.

Select the auto loop beat.

3 Press the [AUTO BEAT LOOP] button.

A loop with the specified number of beats is set and loop playback starts. Normal playback continues in the background during loop playback.

4 Press the [AUTO BEAT LOOP] button again.

Looping is canceled and playback starts from the position reached in the background.

- To cancel the slip mode, press the [SLIP] button again.

Manual slip looping

❖ Creating a loop and slipping it

1 Press the [SLIP] button.

The mode switches to the slip mode.

2 Press the [LOOP IN] button, then press [LOOP OUT] button.

Loop playback starts.

Normal playback continues in the background even during loop playback.

3 Press the [LOOP OUT] button while pressing the [SHIFT] button.

Looping is canceled and playback starts from the position reached in the background.

- To cancel the slip mode, press the [SLIP] button again.

Using the dual deck mode

The dual deck mode is a function allowing you to control both decks simultaneously when mixing two different tracks on deck 1 and deck 3 (or on deck 2 and deck 4).

The explanation below describes an example of the operation for controlling decks 1 and 3 simultaneously.

Turning the DUAL DECK mode on

● Press the [DECK 3] button while pressing the [DECK 1] button or press the [DECK 1] button while pressing the [DECK 3] button.

DUAL DECK mode turns on and the [DECK] button, which was pressed first, flashes and the [DECK] button, which was pressed later, lights.

Status display in the dual deck mode

- When entering DUAL DECK mode, the deck status of the [DECK] button, which was pressed first, is displayed.

Turning the DUAL DECK mode off

● Press the [DECK 1] or [DECK 3] button.

The dual deck mode turns off, and the [DECK] button lights.

The controller switches to the deck of the pressed [DECK] button.

Functions that can be controlled in the dual deck mode

The functions below can be controlled on the two decks simultaneously in the dual deck mode.

Button or control that is operated	Function
Jog dial	Pause, resume play, scratch, pitch bend, search, slip scratch
SLIP button	Slip mode on/off, VINYL mode on/off
MASTER TEMPO button	Master tempo on/off
AUTO BEAT LOOP button	Auto loop on, active loop on/off, slip auto loop
LOOP 1/2X button	Loop beat selection, loop half, loop move
LOOP 2X button	Loop beat selection, loop double, loop move
LOOP IN button	Loop in, loop in adjust, move to loop in point, 4-beat loop, slip manual loop
LOOP OUT button	Loop out, loop out adjust, reloop/eject, manual slip loop
HOT CUE mode button	Hot cue mode, beat jump mode
PAD FX1 mode button	Pad FX mode 1, pad FX mode 2
SLICER mode button	Slicer mode, Slicer loop mode
SAMPLER mode button	Sampler mode, velocity sampler mode
Performance pads	Hot cue trigger, hot cue deletion, slip hot cue, slicer trigger, beat jump trigger, pad FX trigger ^[1]
PARAMETER ◀ button, PARAMETER ▶ button	Pad FX beat selection, slice roll beat selection, slice length selection, beat jump range switch ^[2]
PLAY/PAUSE ►/II button	Start play, pause
CUE button	Current cue setting, cue back, cue sampler, move to start of track and play
SYNC button	Sync on/off
SLIP REVERSE button	Slip reverse, reverse playback on/off
NEEDLE SEARCH pad	Needle search
QUANTIZE button	Quantize on/off

[1] Except when the pad mode is the sampler mode or velocity sampler mode.

[2] Except when the pad mode is the hot cue mode.

Functions that are limited in the dual deck mode

For the following functions, only the deck that is displayed can be operated when in the dual deck mode.

Button or control that is operated	Function
SHIFT + MASTER TEMPO buttons	Change tempo range
TEMPO slider	Adjust tempo
SHIFT + SYNC buttons	Set target deck to beat sync master
CAPTURE button + pad	Load loop of target deck in sampler slot
SHIFT + CAPTURE buttons	Load slicer target area of target deck in sampler slots
PARAMETER button (in the hot cue mode)	Call out cue point or loop of loaded track

Deck status mirroring function

When the statuses below differ on the respective decks, they are automatically set to the same statuses as on the deck whose [DECK] button is lit.

- Vinyl mode status, pad mode status, slip mode status

Using the fader start function

Using the channel fader start function

- To use the channel fader start function, set the crossfader assign selector switch to [THRU].

1 Set the cue.

Pause at the position from which you want to start playback, then press the [CUE] button for the corresponding deck.

- Cues can also be set by moving the channel fader from the back to the position nearest you while pressing the [SHIFT] button in the pause mode.

2 While pressing the [SHIFT] button, move the channel fader from the position nearest you towards the back.

Playback of the track starts from the set cue point.

- When the channel fader is moved back to the position nearest you while pressing the [SHIFT] button during playback, the track moves instantaneously back to the set cue point and the pause mode is set. (Back Cue)

If no cue is set, playback starts from the beginning of the track.

When the channel fader is moved from the back to the position nearest you while pressing the [SHIFT] button when standing by at a cue, track playback starts from the set cue.

Using the crossfader start function

To use the crossfader start function, set the crossfader assign selector switch of the channel you want to move to [A] or [B].

1 Set the cue.

Pause at the position from which you want to start playback, then press the [CUE] button for the corresponding deck.

- Cues can also be set by moving the crossfader to the left edge or the right edge while pressing the [SHIFT] button in the pause mode.

2 Move the crossfader to the left edge or right edge position.

Set to the edge opposite the side on which the channel you want to use with the fader start function is set.

3 While pressing the [SHIFT] button, move the crossfader in the opposite direction from the left edge or right edge.

Playback of the track starts from the set cue point.

- When the crossfader is returned to the original position while pressing the [SHIFT] button during playback, the track moves instantaneously back to the set cue point and the pause mode is set (Back Cue).

If no cue is set, playback starts from the beginning of the track.

When the crossfader is moved from the left edge to the right edge (or from the right edge to the left edge) while pressing the [SHIFT] button when standing by at a cue, track playback starts from the set cue point.

Adjusting the crossfader's operating load

The load (resistance) when the crossfader is operated can be adjusted using a flathead screwdriver.

- You can adjust the play (cut lag) on both edges of the crossfader. For details, see *Adjusting the crossfader cut lag* on page 26.

1 Move the crossfader to the right edge.

2 Insert the flathead screwdriver into the [FEELING ADJUST] adjustment hole and turn it.

- Turn clockwise: The load decreases (the resistance of fader movement gets weaker).
- Turn counterclockwise: The load increases (the resistance of fader movement gets stronger).

Using effects

The effect functions of rekordbox dj can be roughly divided into three types: BEAT FX, SOUND COLOR FX, and RELEASE FX.

The following explains how to operate the three effect function types, BEAT FX, SOUND COLOR FX, and RELEASE FX.

For details on pad FX for operating these effects using the performance pads, see *Using the pad FX* on page 16.

Using the beat FX function

Beat FX can apply an effect matched to the tempo (BPM) of the track loaded in the deck.

Beat FX has the two effect units FX1 and FX2, and the deck assigned on each of these units can be freely set.

Also, beat FX has two FX modes: beat FX single mode and beat FX multi mode.

The beat FX single mode allows you to select one effect and use up to three parameters for one effect unit.

The beat FX multi mode allows you to use up to three effects for one effect unit simultaneously.

Using effects in the beat FX multi mode

The following describes how to assign an effect unit to channel 1.

1 Press the [RELEASE FX] control while pressing the [SHIFT] button to switch the FX mode of rekordbox dj to the beat FX multi mode.

The mode switches between the beat FX multi mode and beat FX single mode each time the buttons are operated.



2 Press the [FX1] button or [FX2] button of channel 1 to select the effect unit to assign.

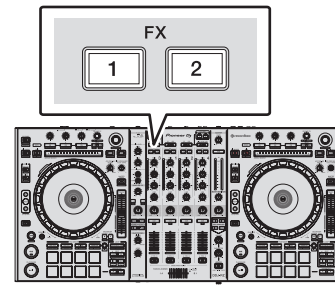

3 Press the effect parameter 1 button while pressing the [SHIFT] button to select the first effect type.

To select the second effect type, press the effect parameter 2 button while pressing the [SHIFT] button.

To select the third effect type, press the effect parameter 3 button while pressing the [SHIFT] button.

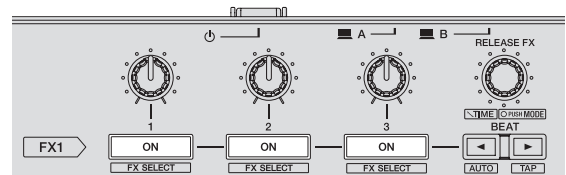

The currently selected effect type is displayed on the rekordbox dj screen.

4 Press the effect parameter 1 button to turn the first effect on.

Press the effect parameter 2 button to turn the second effect on.

Press the effect parameter 3 button to turn the third effect on.

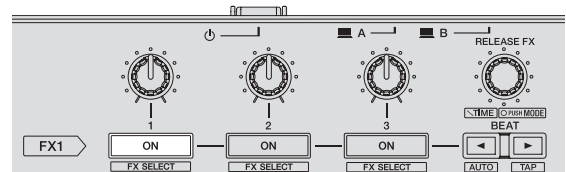

The [ON] key for the corresponding effect is highlighted on the rekordbox dj screen.

5 Operate the effect parameter 1 control to adjust the parameter of the first effect.

Operate the effect parameter 2 control to adjust the parameter of the second effect.

Operate the effect parameter 3 control to adjust the parameter of the third effect.

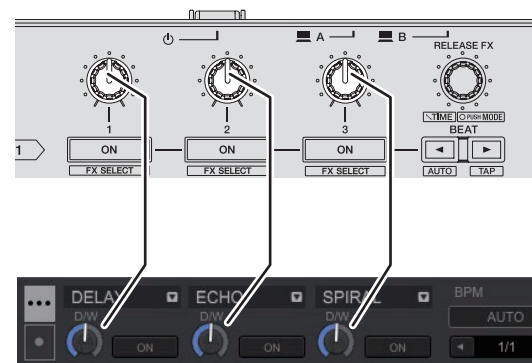

The balance between the original sound and effect sound can be adjusted.

6 Turn the [RELEASE FX] control while pressing the [SHIFT] button.

Adjusts the effect time.

7 Press the [BEAT </>] button.

The beat interval for applying the effect can be adjusted.

Using an effect in the beat FX single mode

The following describes how to assign an effect unit to channel 1.

- 1 Press the [RELEASE FX] control while pressing the [SHIFT] button to switch the FX mode of rekordbox dj to the beat FX single mode.

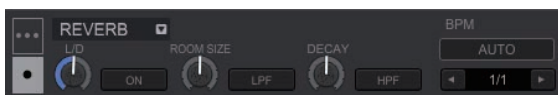

- 2 Press the [FX1] button or [FX2] button of channel 1 to select the effect unit to assign.

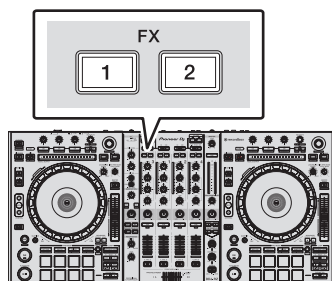

- 3 Press one of the effect parameter buttons while pressing the [SHIFT] button to select the effect type.

The selected effect is displayed on the rekordbox dj screen.

- 4 Press the effect parameter 1 button to turn the effect on.

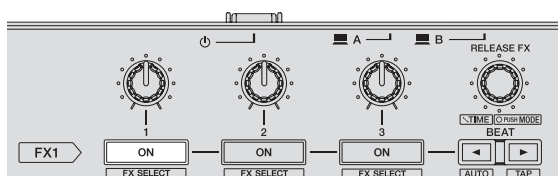

The [ON] button for the effect is highlighted on the rekordbox dj screen and the effect is enabled.

- 5 Operate the effect parameter 2 button or the effect parameter 3 button to switch the effect's parameter.

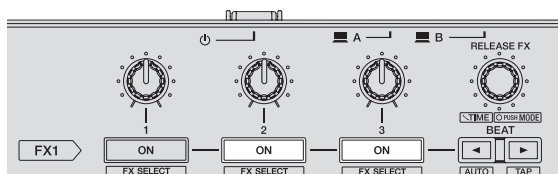

- The parameter button corresponding to the effect is highlighted on the rekordbox dj screen, the parameter is enabled, and the effect of the effect changes.

- 6 Operate the effect parameter control(s) to adjust the effect's parameter(s).

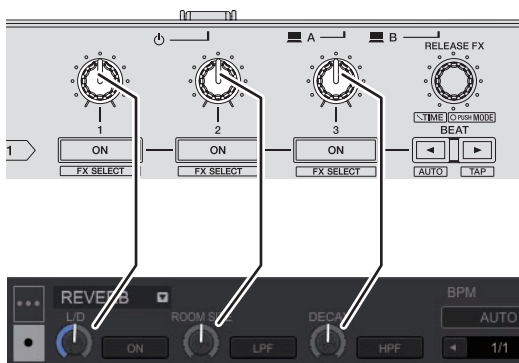

The parameters differ depending on the effect type.

- 7 Turn the [RELEASE FX] control while pressing the [SHIFT] button.

Adjusts the effect time.

- 8 Press the [BEAT </>] button.

The beat interval for applying the effect can be adjusted.

Switching the effect's tempo mode

With rekordbox dj effects, there are two ways to set the beat FX tempo: with "BPM auto mode" and "BPM tap mode".

- By default, the BPM auto mode is set.

❖ BPM auto mode

The track's BPM value is used as the basis for the effect's tempo.

When the [BEAT <] button is pressed for at least one second while pressing the [SHIFT] button, the mode switches to the BPM auto mode.

❖ BPM tap mode

The BPM used as the base value for the effect is calculated from the interval at which the [BEAT <] button is tapped with a finger while pressing the [SHIFT] button. When the [BEAT >] button is pressed for at least one second while pressing the [SHIFT] button, the mode switches to the BPM tap mode.

Using the release FX

Release FX enables you to turn off the beat FX that was on up until now simultaneously with the adding of an effect.

The playing track and effect sound can be smoothly connected by using release FX. One release FX per effect unit can be used in both the beat FX multi mode and beat FX single mode.

The following describes how to assign an effect unit to channel 1.

- 1 Press the [FX1] button or [FX2] button of channel 1 to select the effect unit to assign.

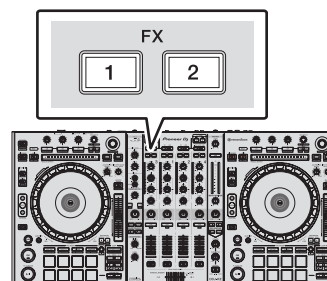

- 2 Turn the [RELEASE FX] control to select the release FX type.

The currently selected effect type is displayed on the rekordbox dj screen.

- 3 Click the [<] button or [>] button on the rekordbox dj screen to set the release FX beat.

The release FX beat can be set separately from the the beat setting for beat FX.

- 4 Press and hold the [RELEASE FX] control.

The selected release FX turns on, and the beat FX in the same effect unit that was on up until now turns off.

- 5 Release the [RELEASE FX] control.

Release FX turns off.

Using the SOUND COLOR FX function

These effects change in association with the [COLOR] controls for the different channels.

When the unit is connected with rekordbox dj, the SOUND COLOR FX included in rekordbox dj can be used.

SOUND COLOR FX included in the unit can be used with external input.

- 1 Press one of the [SOUND COLOR FX] buttons.

This selects the type of effect.

The button that was pressed flashes.

- Even when one of the [SOUND COLOR FX] buttons is selected, if a different [SOUND COLOR FX] button is pressed, the newly pressed button is selected.
- The same effect is set for all channels.

- 2 Turn the [COLOR] control.

The effect is applied to the channel(s) for which the control(s) was (were) pressed.

Canceling the SOUND COLOR FX effect

Press the flashing [SOUND COLOR FX] button.

The effect is canceled.

Types of SOUND COLOR FX effects

rekordbox dj includes various SOUND COLOR FX.

When the software is connected with the unit, SPACE, JET, PITCH and FILTER are selected by default.

Effects other than these can be used by changing the SOUND COLOR FX settings in rekordbox dj.

Switch SOUND COLOR FX of rekordbox dj to the [USER] mode to change the SOUND COLOR FX setting. You can set each effect to the desired effect.

Effect Name	Descriptions	[COLOR] control
SPACE	Applies a reverberation effect to the original sound.	Turn counterclockwise: Applies the reverberation effect to the mid- and low ranges. Turn clockwise: Applies the reverberation effect to the mid- and high ranges.
JET	The flanger effect is applied.	Counterclockwise: Applies a flanger effect, which emphasizes low-pitched sound. Clockwise: Applies a flanger effect, which emphasizes high-pitched sound.
PITCH	Changes the sound pitch.	Turn counterclockwise: The pitch decreases. Turn clockwise: The pitch increases.
FILTER	Outputs sound that has passed through a filter.	Turn counterclockwise: Gradually decreases the low-pass filter's cutoff frequency. Turn clockwise: Gradually increases the high-pass filter's cutoff frequency.

Using the oscillator function

A built-in sound source can be added to the audio master output.

When the unit is connected with rekordbox dj, the sound sources of rekordbox dj and the sound sources included in the unit can be used.

The sound sources included in the unit can be used with external input.

1 Use the [SOURCE] switch to select the channel to which you want to add oscillator sound.

- [USB-A]: Uses the sound sources of rekordbox dj installed on the PC connected to USB-A.
- [INT.]: Uses the sound sources of the controller unit.
- [USB-B]: Uses the sound sources of rekordbox dj installed on the PC connected to USB-B.

2 Turn the [OSC SAMPLER PARAMETER] control.

Turning the control clockwise or counterclockwise adjusts the oscillator sound tone.

3 Turn the [OSC SAMPLER VOLUME] control.

Adjusts the sound level of oscillator sound.

4 Press one of the [OSC SAMPLER SELECT] buttons.

This selects the type of oscillator sound.

The button that was pressed flashes for a certain period of time.

- You can select more than one oscillator sound.
- The sound generating method differs depending on the [SOURCE] switch.
- [INT.]: Sound continues to be output while the button is pressed.
- [USB-A]/[USB-B]: In the [Gate Mode] setting of the connected rekordbox, you can switch between outputting sound while the button is pressed and playing back to the end of the track if the button is pressed.
For details, see the rekordbox software's manual.

Quitting the oscillator function

Oscillator sound automatically stops after a certain period of time and the [OSC SAMPLER SELECT] button changes from flashing to lighted.

Type of oscillator sound

When the software is connected with the unit, the following sound sources are selected by default.

The oscillator of rekordbox dj can be changed to the desired sound source. For how to change the sound source of the oscillator, see the rekordbox software's manual.

Effect Name	Descriptions	OSC SAMPLER PARAMETER control (when using sound sources included in the unit)
NOISE	Generates white noise.	Turn counterclockwise: The cut-off frequency of the filter through which the white noise passes gradually decreases. Turn clockwise: The cut-off frequency of the filter through which the white noise passes gradually increases.
SINE	Generates sine wave sound.	Turn counterclockwise: Reduces the frequency of the sine wave. Turn clockwise: Increases the frequency of the sine wave.
SIREN	Generates a siren-like sound.	Turn counterclockwise: Reduces the reverberation time of the siren sound. Turn clockwise: Increases the reverberation time of the siren sound.
HORN	Generates a horn-like sound.	Turn counterclockwise: Reduces the reverberation time of the horn sound. Turn clockwise: Increases the reverberation time of the horn sound.

- When using the sound sources included in rekordbox dj, you can control the sound pitch with the OSC SAMPLER PARAMETER control. Left turn lowers the pitch, and right turn raises the pitch.

Using external inputs

This unit is equipped with four sets of external inputs for connecting CD players, analog turntables, etc. This unit's 4-channel mixer can be used to mix externally input sound without passing through a computer. The mixer functions below can be used without a computer connected.

Notes

- For details on the respective items, see *Connections* (p.6) and *Part names and functions* (p.8).
- The functions of rekordbox dj do not work for external input.
- The values adjusted with the various controls for rekordbox dj differ from the values adjusted with the various controls for external input.

Mixer section

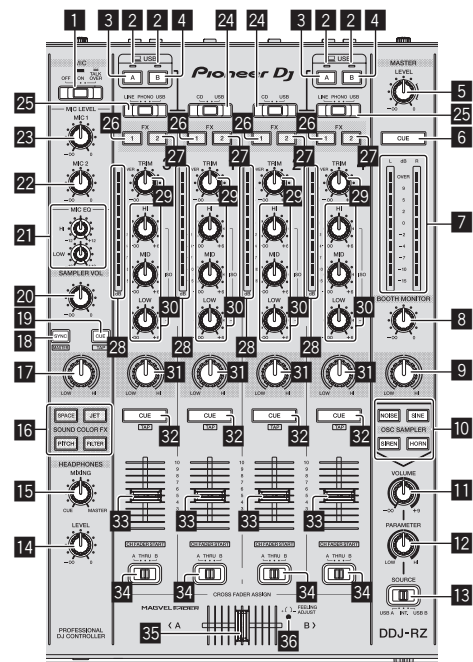

- 1 OFF, ON, TALK OVER selector switch
- 2 USB connection indicator
- 3 USB (A) button
- 4 USB (B) button

- 5 MASTER LEVEL control
- 6 MASTER CUE button
- 7 Master level indicator
- 8 BOOTH MONITOR control
- 9 MASTER OUT COLOR control
- 10 OSC SAMPLER SELECT button
- 11 OSC SAMPLER VOLUME control
- 12 OSC SAMPLER PARAMETER control
- 13 SOURCE selector switch
- 14 HEADPHONES LEVEL control
- 15 HEADPHONES MIXING control
- 16 SOUND COLOR FX buttons
- 17 MIC COLOR control
- 18 SAMPLER SYNC button
- 19 SAMPLER CUE button
- 20 SAMPLER VOLUME control
- 21 EQ (HI, LOW) controls
- 22 MIC2 control
- 23 MIC1 control
- 24 CD, USB selector switch
- 25 LINE, PHONO, USB selector switch
- 26 FX 1 assign button
- 27 FX 2 assign button
- 28 Channel Level Indicator
- 29 TRIM control
- 30 ISO (HI, MID, LOW) controls
- 31 COLOR control
- 32 Headphones CUE button
- 33 Channel fader
- 34 Crossfader assign selector switch
- 35 Crossfader
- 36 FEELING ADJUST adjustment hole

Front panel

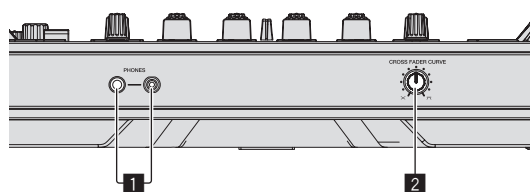

- 1 PHONES jacks
- 2 CROSS FADER CURVE selector switch

Using a microphone

- 1 Connect a microphone to the [MIC1] or [MIC2] terminal.
- 2 Set the [OFF, ON, TALK OVER] selector switch to [ON] or [TALK OVER].
 - [ON]: The indicator lights.
 - [TALK OVER]: The indicator flashes.

- When set to [TALK OVER], the sound of channels other than the [MIC1] channel is attenuated by 18 dB (default) when a sound of -10 dB or greater is input to the microphone.
- The sound attenuation level while [TALK OVER] is selected can be changed in utility mode. For the method to effect that change, see *Changing the talk over function level* on page 26.
- The talk over mode can be switched to the normal mode or the advanced mode. For instructions on changing it, see *Changing the talk over function setting* on page 25.

3 Turn the [MIC1] or [MIC2] control.

Adjust the level of the sound output from the [MIC1] channel.

- Pay attention that rotating to the extreme right position outputs a very loud sound.

4 Input audio signals to the microphone.

❖ Adjusting the sound quality

Turn the [EQ (HI, LOW)] controls.

The adjustable ranges for the respective controls are as shown below.

- **HI:** -12 dB to +12 dB (10 kHz)
- **LOW:** -12 dB to +12 dB (100 Hz)

Mixing the sound of a DJ player, etc.

- 1 Connect the DJ player or other line level output device to the [CD] or [LINE] terminals.
- 2 Set the [LINE, PHONO, USB] selector switch or [CD, USB] selector switch to [LINE] or [CD].
- 3 Operate the [TRIM] control and channel fader to adjust the sound level output from each channel.

Mixing the sound of an analog turntable, etc.

- 1 Connect the analog player or other phono level (for MM cartridges) output device to the [PHONO] terminals.
- 2 Set the [LINE, PHONO, USB] selector switch to [PHONO].
- 3 Operate the [TRIM] control and the channel faders to adjust the audio level output from the respective decks.

Using SOUND COLOR FX with external input

The four **SOUND COLOR FX** types included in the unit can be used with external input.

For how to operate **SOUND COLOR FX**, see *Using the SOUND COLOR FX function* on page 21.

Using the oscillator function with external input

The four oscillator types included in the unit can be used with external input.

For how to operate the oscillator, see *Using the oscillator function* on page 22.

Changing the settings

Launching utilities mode

If the utilities mode is launched while the DJ application is running, the set status may not be displayed properly.

- 1 **Disconnect the USB cable from your computer.**
- 2 **Press the [⏻] switch on this unit's rear panel to set this unit's power to standby.**
Set this unit's power to the standby mode.
- 3 **While pressing both the [SHIFT] and [PLAY/PAUSE ▶/II] buttons on the left deck, press the [⏻] switch on this unit's rear panel.**
Utilities mode is launched.
- 4 **After setting this unit to the utility settings mode, operate the controller for the item whose settings you want to change.**
See the explanations below for the settings that can be changed.
- 5 **Press the [⏻] switch on this unit's rear panel to set this unit's power to standby.**
To save the settings, set the [⏻] switch on this unit's rear panel to standby and quit utilities mode.

Utilities modes

The following settings can be changed:

- MIDI controller setting
- Fader start setting
- Master output attenuator level setting
- Slip mode flashing setting
- Demo mode setting
- Setting of the velocity curve in the sampler velocity mode
- Setting for sending intervals of the jog dial's MIDI message
- Setting of the auto standby function
- Setting of talk over function
- Setting of talk over function level
- Cut lag setting of crossfader
- Output setting of microphone to booth monitor
- Peak limiter setting
- Brightness setting of jog ring

Forcefully using the unit as the general MIDI controller

The unit automatically changes operation as follows depending on whether rekordbox is running.

- When rekordbox is running, controller operation depends on the rekordbox functions.
- When rekordbox is not running, the unit operates as a general MIDI controller.

Even though rekordbox is running, you can forcefully operate the unit as a general MIDI controller.

Press the [MASTER TEMPO] button on the left deck.

- [MASTER TEMPO] button off: Operation automatically changes depending on whether or not rekordbox is running.
- [MASTER TEMPO] button lit: Regardless of whether or not rekordbox is running, the unit is forcefully operated as a general MIDI controller.

Changing the fader start setting

The fader start function's setting can be changed.

Press one of the effect parameter buttons on the left deck.



- Effect parameter 1 button lit: Fader start enabled
- Effect parameter 2 button lit: Fader start disabled

Setting the master output's attenuator level

- The default is 0 dB.

Press one of the left deck's [HOT CUE] mode, [PAD FX1] mode, and [SLICER] mode buttons.

- [HOT CUE] mode button lit: 0 dB (no attenuation)
- [PAD FX1] mode button lit: -3 dB
- [SLICER] mode button lit: -6 dB

Changing the slip mode flashing setting

When slip mode is on, the buttons available in slip mode (such as the jog dial indicator, [AUTO BEAT LOOP] button, and [PLAY/PAUSE ▶/II] button) can be set to flash or not flash. The flashing method of the [SLIP] button in slip mode also varies depending on the setting.

- By default, slip mode flashing is set to mode 1.

Press the performance pad on the left side to select a setting.

The currently selected setting can be understood by looking at which pad lights.

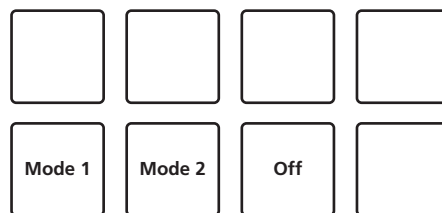

- Mode 1: When slip mode is turned on, the buttons available in slip mode flash for approximately one second. During slip mode, the [SLIP] button flashes only while payback continues in the background.
- Mode 2: When the slip mode is turned on, the buttons available in slip mode flash for approximately one second. During slip mode, the [SLIP] button continues flashing.
- Off: The buttons available in slip mode do not flash. During slip mode, the [SLIP] button flashes only while payback continues in the background.

Changing the demo mode setting

On this unit, the demo mode is set if no operation is performed for 10 minutes under normal usage conditions. This demo mode can be changed.

- By default, demo mode starts when there is no operation for 10 minutes.
- When any control or button on this unit is operated while in the demo mode, the demo mode is canceled.

Press one of the [SOUND COLOR FX] buttons.

- [SPACE] button lit: Demo mode is disabled
- [JET] button lights: Demo mode starts when there is no operation for 1 minute
- [PITCH] button lights: Demo mode starts when there is no operation for 5 minutes
- [FILTER] button lights: Demo mode starts when there is no operation for 10 minutes

Changing the velocity curve setting of velocity sampler mode

Set the velocity curve of the velocity sampler mode. The velocity curve can be selected from four types.

- By default, curve 3 is set.

Press the [AUTO BEAT LOOP] button on the deck whose setting you want to set.

The velocity curve setting changes each time the [AUTO BEAT LOOP] button is pressed.

The currently set value is indicated by how the [LOOP 1/2X], [LOOP 2X], [LOOP IN] and [LOOP OUT] buttons light.

Curve 1

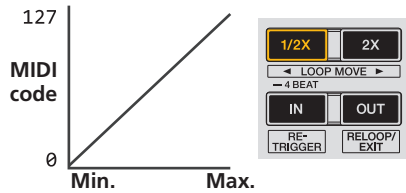

Strength which performance pad is pressed

Curve 2

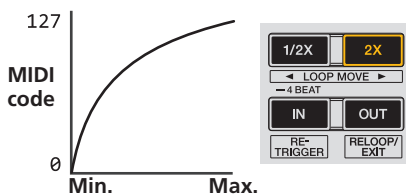

Strength which performance pad is pressed

Curve 3

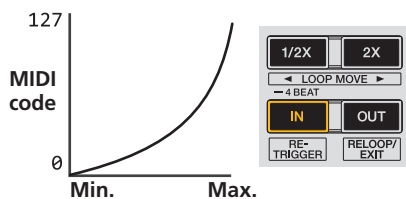

Strength which performance pad is pressed

Curve 4

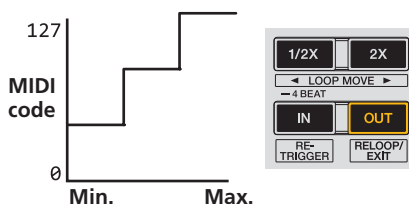

Strength which performance pad is pressed

Adjusting the jog dial's MIDI message sending interval

This unit is equipped with a mode for adjusting the jog dial's MIDI message sending interval.

Depending on your computer's operating system and specifications, the jog dial may not operate properly if the sending interval of MIDI message for JOG dial is too short. In this case, follow the procedure below to adjust the MIDI message sending interval.

- From a short MIDI sending interval, increase the interval to a length at which no problems occur.
- The default is 1 ms.

Press the [SHIFT] button on the left deck.

The MIDI message sending interval setting changes each time the button is pressed. The currently set value is indicated by how the master level indicator is lit.

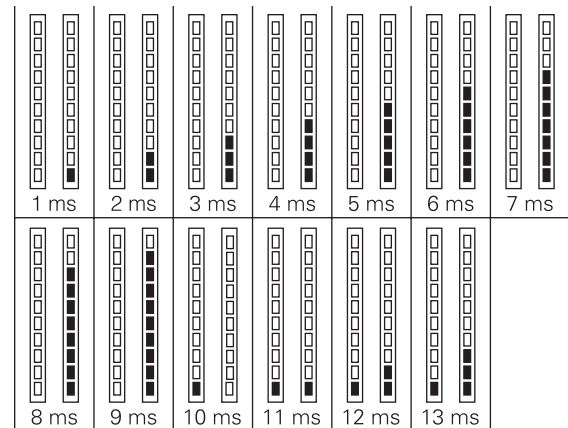

Disabling the auto standby function

- When auto standby function is set to on, if 4 hours have passed while the following conditions are all met, the unit automatically enters standby status.
 - Buttons and controls of the unit except the [MIC1] control and [MIC2] control are not operated.
 - That no audio signals of -18 dB or greater are input to this unit's input terminals.
- When the [PANEL (WAKE UP)] button is pressed, the standby mode is canceled.
- By default, the auto standby function is enabled.

Press the [GRID ADJUST] button of the left side deck.

- [GRID ADJUST] button lit: Auto standby function is enabled
- [GRID ADJUST] button off: Auto standby function is disabled

Changing the talk over function setting

About talk over mode

The talk over function has the two modes described below.

Advanced talk over mode: Sound other than the microphone channel is output with only the midrange attenuated per the talk over level setting.

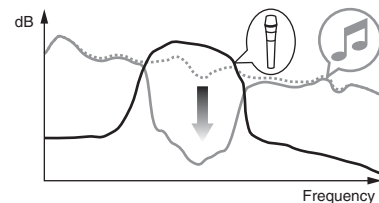

Normal talk over mode: Sound other than the microphone channel is output attenuated per the talk over level setting.

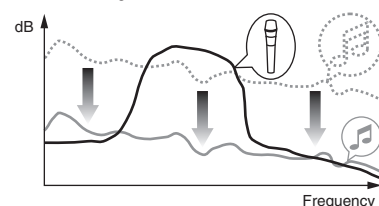

- By default, the advanced talk over mode is set.

Press the [GRID SLIDE] button of the left side deck.

- [GRID SLIDE] button lit: Advanced talk over mode
- [GRID SLIDE] button off: Normal talk over mode

Changing the talk over function level

Sets the talk over function's sound attenuation level.

- By default, the level is set to -18 dB.

Press the performance pad on the left side to select a setting.

The currently selected setting can be understood by looking at which pad lights.

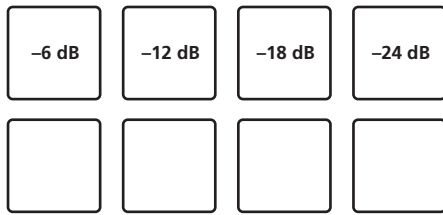

Adjusting the crossfader cut lag

Adjust the play (cut lag) on both edges of the crossfader. It can be adjusted between 0 (0.74 mm) and 52 (5.94 mm) in units of 0.1 mm.

- By default, it is set to 6 (1.34 mm).

Turn the rotary selector on the left deck.

The current setting (0 to 52) is displayed by the lit condition of the channel level indicator.

- Number of lit segments of the [CH3] channel level indicator: Ten's place
- Number of lit segments of the [CH1] channel level indicator: One's place

Setting the microphone output of the booth monitor

- By default, it is set to output microphone sound from the [BOOTH OUT] terminal.

Press the [SLIP] button of the left deck.

- [SLIP] button lit: Outputs microphone sound from the [BOOTH OUT] terminal
- [SLIP] button off: Does not output microphone sound from the [BOOTH OUT] terminal

Changing the peak limiter setting

Lessens sudden, unpleasant digital clipping of the master output.

- By default, the peak limiter is set to enabled.

Press the [LOAD] button of the left side deck.

- [LOAD] button lit: Peak limiter enabled
- [LOAD] button off: Peak limiter disabled

Adjusting the brightness of jog ring

You can adjust the brightness of the illumination around the jog dial.

- The same setting is applied to the jog dials on the left and right decks.
- By default, it is set to bright light.

Press the top of the jog dial.

Each time the top of the jog dial is pressed, the setting changes.

The brightness can be set in three levels: light, dark, and off. The current setting can be understood by the jog ring lit condition.

About the setting utility software

The setting utility can be used to make the checks and settings described below.

- Setting the Mixer Mode
- Checking the status of this unit's input selector switches
- Setting the audio data output from this unit to the computer
- Adjusting the buffer size (when ASIO is used)
- Checking the version of the driver software

Displaying the setting utility

For Windows

Click [Start] menu > [All Programs] > [Pioneer] > [DDJ-RZ] > [DDJ-RZ Settings Utility].

For Mac OS X

Click [Macintosh HD] icon > [Application] > [Pioneer] > [DDJ-RZ] > [DDJ-RZ Settings Utility].

Setting the Mixer Mode

Display the setting utility before starting.

1 Click the [Mixer Mode] tab.

2 Click the pull-down menu.

Select Mixer Mode according to the operating environment.

Internal Mixer Mode

- Select this when using the DJ application internal mixer.

External Mixer Mode

- Select this when inputting the audio output of each deck of the DJ application to each channel of DDJ-RZ.
- rekordbox dj operates as Internal Mixer Mode regardless of the Mixer Mode setting.
- When using rekordbox dj, set this to Internal Mixer Mode.

Checking the status of this unit's input selector switches

Display the setting utility before starting.

Click the [CONTROLLER INPUT] tab.

When Mixer Mode is Internal Mixer Mode

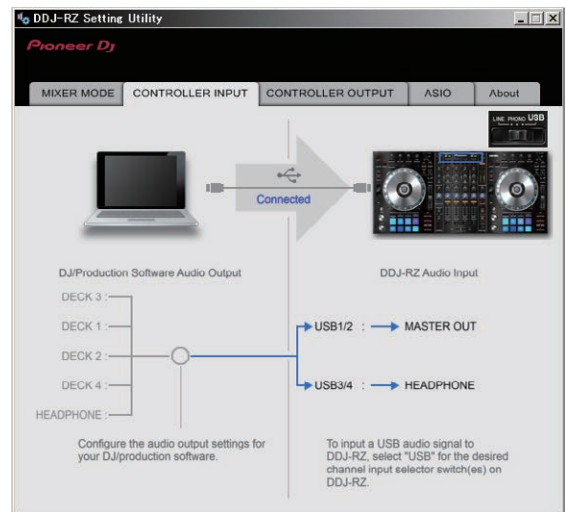

When Mixer Mode is External Mixer Mode

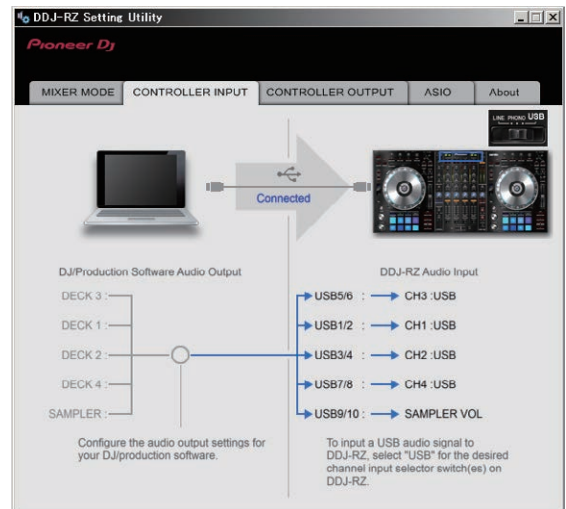

Setting the audio data output from this unit to the computer

When rekordbox is running and using this unit as the default audio device, set the audio data output in rekordbox. Display the setting utility before starting.

1 Click the [CONTROLLER OUTPUT] tab.

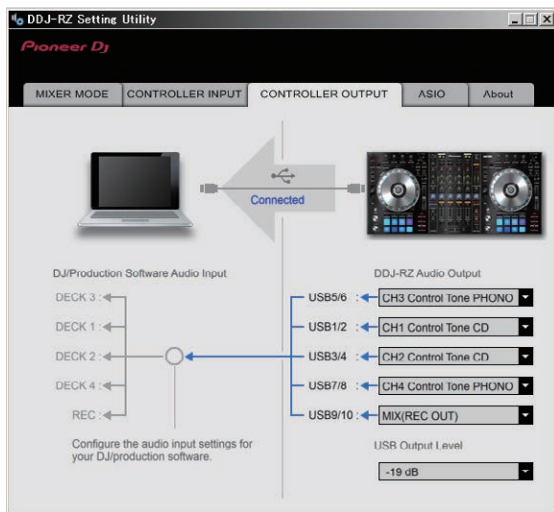

2 Click the [DDJ-RZ Audio Output] pull-down menu.

Select and set the audio data to be output to the computer from the flow of audio signals inside this unit.

CH1 (USB1/2)	CH2 (USB3/4)	CH3 (USB5/6)	CH4 (USB7/8)	CH5 (USB9/10)
—	—	CH3 Control Tone PHONO ^[1]	CH4 Control Tone PHONO ^[1]	MIX (REC OUT) ^[2]
CH1 Control Tone CD ^[1]	CH2 Control Tone CD ^[1]	CH3 Control Tone LINE ^[1]	CH4 Control Tone LINE ^[1]	Cross Fader A ^[2]
Post CH1 Fader ^[2]	Post CH2 Fader ^[2]	Post CH3 Fader ^[2]	Post CH4 Fader ^[2]	Cross Fader B ^[2]
Cross Fader A ^[2]	Cross Fader A ^[2]	Cross Fader A ^[2]	Cross Fader A ^[2]	MIC
Cross Fader B ^[2]	Cross Fader B ^[2]	Cross Fader B ^[2]	Cross Fader B ^[2]	Post CH1 Fader ^[2]
MIC	MIC	MIC	MIC	Post CH2 Fader ^[2]
—	—	—	—	Post CH3 Fader ^[2]
—	—	—	—	Post CH4 Fader ^[2]

- [1] The audio data is output with the same volume at which it is input to this unit, regardless of the [USB Output Level] setting.
- [2] When using for applications other than recording, pay attention to the DJ application's settings so that no audio loops are generated. If audio loops are generated, sound may be input or output at unintended volumes.
- When there is a connection with rekordbox dj, the CH5 setting cannot be changed to other than [MIX (REC OUT)].

3 Click the [USB Output Level] pull-down menu.

Adjust the volume of the audio data output from this unit.

- The [USB Output Level] setting is applied equally to all audio data. However, when [1] on the table at step 2 is selected, the audio data is output with the same volume at which it is input to this unit.
- If not enough volume can be achieved with the DJ software's volume adjustment alone, change the [USB Output Level] setting to adjust the volume of the audio data output from this unit. Note that the sound will be distorted if the volume is raised too high.

Adjusting the buffer size (when ASIO is used)

This function can only be used by those using a Windows operating system.

If an application using this unit as the default audio device (DJ software, etc.) is running, quit that application before adjusting the buffer size. Display the setting utility before starting.

Click the [ASIO] tab.

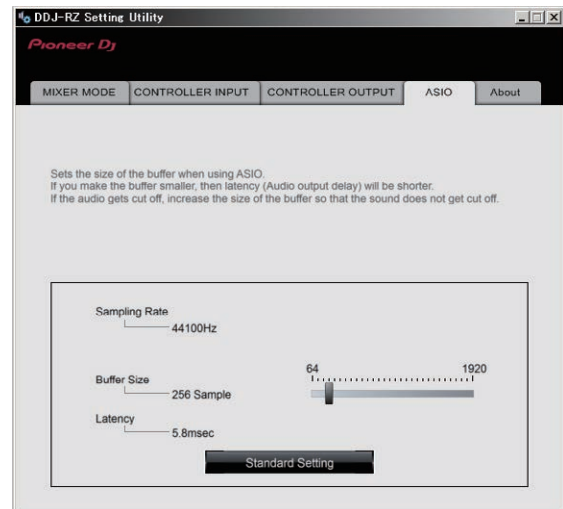

- If the buffer size is made large, drops in audio data (breaks in the sound) occur less easily, but the time lag due to the delay in the transfer of the audio data (latency) increases.

Checking the version of the driver software

Display the setting utility before starting.

Click the [About] tab.

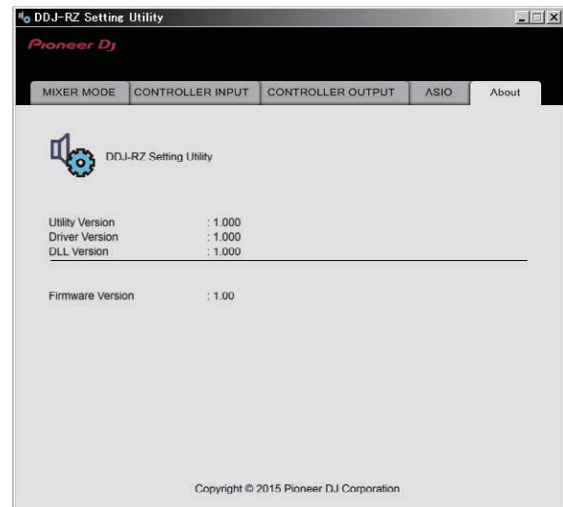

Additional information

Troubleshooting

- If you think that there is something wrong with this unit, check the items below and access the Pioneer DJ site and check **[FAQ]** for the **[DDJ-RZ]**. Sometimes the problem may lie in another component. Inspect the other components and electrical appliances being used. If the problem cannot be rectified, ask your nearest Pioneer authorized service center or your dealer to carry out repair work.
- This unit may not operate properly due to static electricity or other external influences. In this case, proper operation may be restored by turning the power off, waiting 1 minute, then turning the power back on.

Problem	Check	Remedy
The power is not turned on.	Is the [⏻] switch of the power on? Is the power cord properly connected?	Turn the [⏻] switch of the power on. Plug in the power cord to an AC outlet. (page 6)
This unit is not recognized.	Is the included USB cable properly connected? Are you using a USB hub? Is the driver software properly set?	Connect the included USB cable properly. USB hubs cannot be used. Connect the computer and this unit directly using the included USB cable. Set the driver software properly. (page 4)
No sound or small sound.	Are the [TRIM] control, channel fader, crossfader, the [LINE, PHONO, USB] selector switch (or the [CD, USB] selector switch) and the [MASTER LEVEL] control set to the correct position? Are the connected powered speakers, etc., properly set? Are the connection cables properly connected? Are the terminals and plugs dirty? Is the driver software properly set?	Set the [TRIM] control, channel fader, crossfader, the [LINE, PHONO, USB] selector switch (or the [CD, USB] selector switch) and the [MASTER LEVEL] control to the correct position. Properly set the external input selection, volume, etc., on the powered speakers, etc. Connect the connection cables properly. Clean the terminals and plugs before making connections. Set the driver software properly. (page 4)
Distorted sound.	Is the [MASTER LEVEL] control set to the proper position? Is the [TRIM] control set to the proper position?	Adjust the [MASTER LEVEL] control so that the master level indicator's orange indicator lights at the peak level. Adjust the [TRIM] control so that the channel level indicator's orange indicator lights at the peak level.
Sound being played is interrupted when using DJ software.	Is the driver software's latency value suitable?	Set the driver software's latency to a suitable value. Set the DJ software's latency to a suitable value.
Cannot output the microphone sound.	Are the [OFF, ON, TALK OVER] selector switches set to the proper position?	Set the [OFF, ON, TALK OVER] selector switches to the proper position.
Cannot output the sound of the external device.	Is the [LINE, PHONO, USB] selector switch (or [CD, USB] selector switch) set to the proper position?	Set the [LINE, PHONO, USB] selector switch (or [CD, USB] selector switch) to the proper position.
Sound is interrupted when the ASIO driver is set.	Has the ASIO driver been set with rekordbox running?	Set the ASIO driver before launching rekordbox. (page 27)
The indicator flashes and operation is strange.	—	Normal operation can sometimes be restored by unplugging the power cord, waiting at least 1 minute, then plugging the power cord back in. If the symptom persists, unplug the power cord and request repairs.
Operation of rekordbox dj becomes unstable.	Are you using the latest version of the software? Are you using softwares other than rekordbox at the same time? When other USB devices are connected to the computer. Are you using a USB hub? There is a problem with the USB port to which this unit is connected. Is this unit connected to a notebook computer running on its battery? The USB buffer size is too small.	Free updates of rekordbox can be downloaded from the website. Use the most recent version. (page 4) Quit other applications to decrease the load on the computer. If operation continues to be unstable, try disabling the wireless network or other wireless connections, antivirus software, the screen saver, the low power mode, etc. (page 4) Disconnect other USB devices from the computer. When another USB audio device is connected to the computer at the same time, it may not operate or be recognized normally. USB hubs cannot be used. Connect the computer and this unit directly using the included USB cable. If your computer has multiple USB ports, try connecting this unit to a different USB port. Supply power to the notebook computer from an AC power supply. (Depending on the notebook computer's settings, the low power mode may be set when the computer is running on its battery, automatically reducing the performance of the computer itself.) (page 4) Raise the USB buffer size. (page 27)
The jog dial illumination does not turn during playback. (It does turn when scratching.) The [TEMPO] slider does not work when the deck is switched while the sync mode is set. (The TAKEOVER indicator lights.)	Is the setting in the utilities mode wrong?	In utilities mode, check that the unit is not set to be forcefully operated as a general MIDI controller.
The fader start function does not work.	Is a cue set? Is the setting in the utilities mode wrong?	Set a cue. (page 19) Enable the fader start setting in the utilities mode.
The USB connection indicator flashes.	Is the driver software properly set?	Set the driver software properly. (page 4)

Signal flow

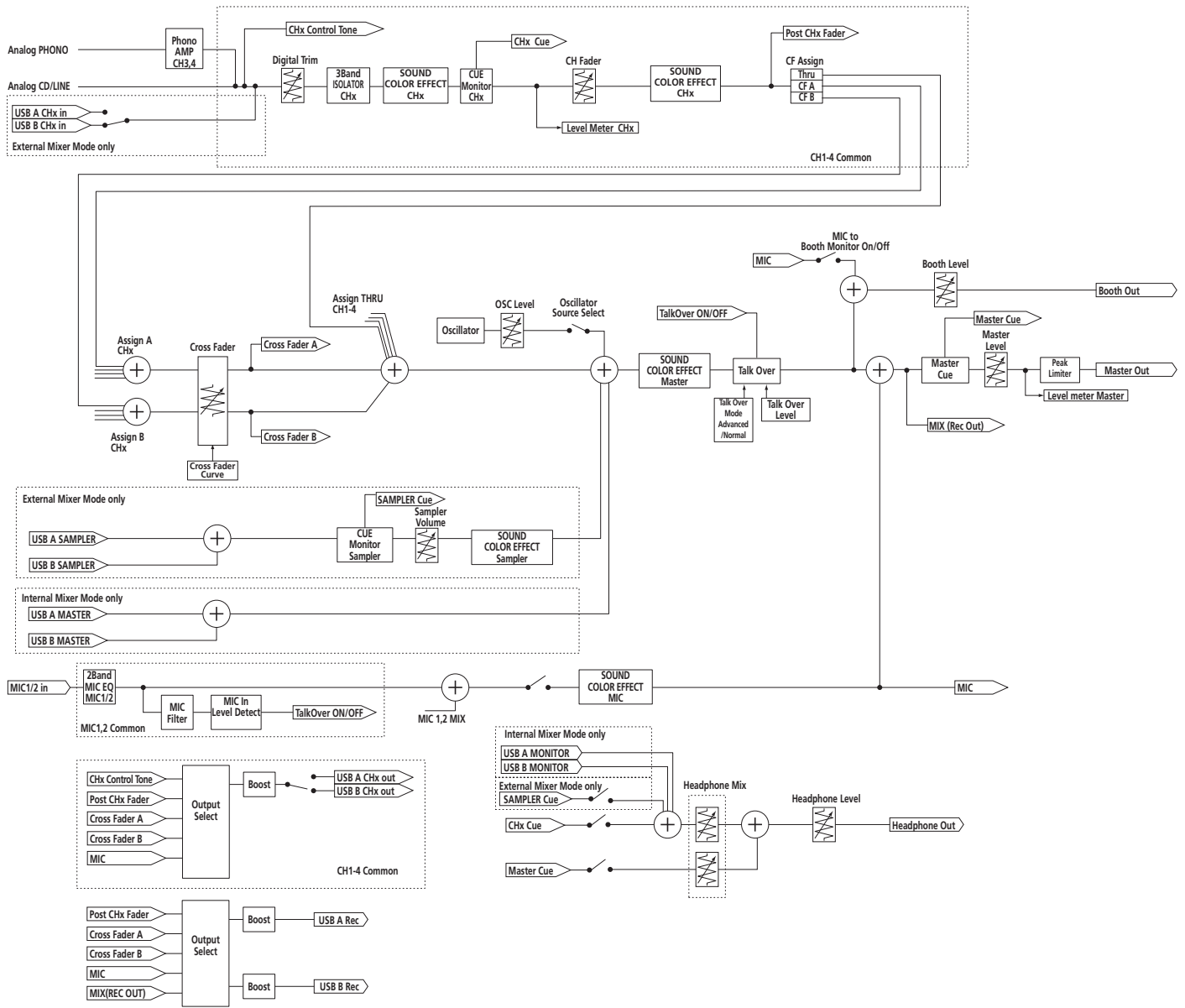

Additional information

Acquiring the manual

Various instructions are sometimes provided as files in PDF format. Adobe® Reader® must be installed in order to view PDF format files.

Downloading the rekordbox software manual

1 Launch a web browser on the computer and access the rekordbox site below.

<http://rekordbox.com/>

2 Download the software manual from the rekordbox software manual download page.

For inquiries on rekordbox, see the rekordbox site indicated above.

Using as a controller for other DJ software

This unit also outputs the operating data for the buttons and controls in MIDI format. If you connect a computer with a built-in MIDI-compatible DJ software via a USB cable, you can operate the DJ software on this unit. The sound of music files being played on the computer can also be output from the DDJ-RZ.

To use as a controller to operate DJ software other than rekordbox, switch to the setting for using software other than rekordbox in the utilities mode. Also, set the DJ software's audio and MIDI related settings.

- For details, see your DJ software's operating instructions.

About MIDI messages

For details on this unit's MIDI messages, see "List of MIDI Messages".

- "List of MIDI Messages" can be acquired from the following URL: <http://www.pioneerdj.com/>

About trademarks and registered trademarks

- "Pioneer DJ" is a trademark of PIONEER CORPORATION, and is used under license.
- rekordbox is a trademark or registered trademark of the Pioneer DJ Corporation.
- Microsoft and Windows are either registered trademarks or trademarks of Microsoft Corporation in the United States and/or other countries.
- Mac OS, iTunes, and Finder are trademarks of Apple Inc., registered in the U.S. and other countries.
- ASIO is a trademark of Steinberg Media Technologies GmbH.

The names of companies and products mentioned herein are trademarks or registered trademarks of their respective owners.

This product has been licensed for nonprofit use. This product has not been licensed for commercial purposes (for profit-making use), such as broadcasting (terrestrial, satellite, cable or other types of broadcasting), streaming on the Internet, Intranet (a corporate network) or other types of networks or distributing of electronic information (online digital music distribution service). You need to acquire the corresponding licenses for such uses. For details, see <http://www.mp3licensing.com>.

Cautions on copyrights

rekordbox restricts playback and duplication of copyright-protected music contents.

- When coded data, etc., for protecting the copyright is embedded in the music contents, it may not be possible to operate the program normally.
- When rekordbox detects that coded data, etc., for protecting the copyright is embedded in the music contents, processing (playback, reading, etc.) may stop.

Recordings you have made are for your personal enjoyment and according to copyright laws may not be used without the consent of the copyright holder.

- Music recorded from CDs, etc., is protected by the copyright laws of individual countries and by international treaties. It is the full responsibility of the person who has recorded the music to ensure that it is used legally.
- When handling music downloaded from the Internet, etc., it is the full responsibility of the person who has downloaded the music to ensure that it is used in accordance with the contract concluded with the download site.

— The specifications and design of this product are subject to change without notice.

© 2015 Pioneer DJ Corporation. All rights reserved.

<DRI1319-A>