

Operating Instructions

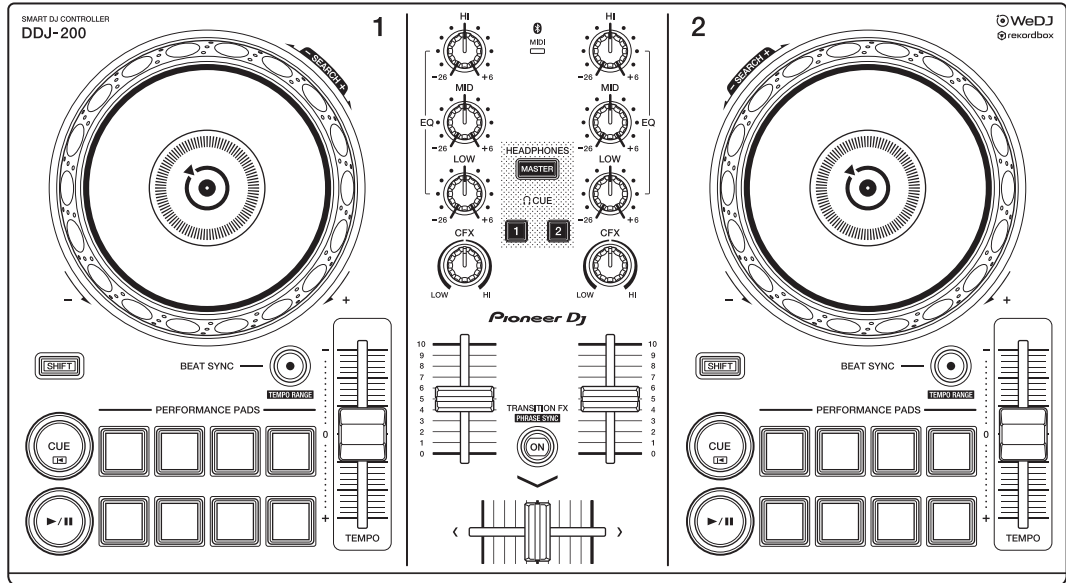

DJ Controller

DDJ-200

pioneerdj.com/support/
rekordbox.com

For FAQs and other support information for this product, visit the websites above.

Pioneer Dj

 **Bluetooth®**

How to read this manual

Thank you for choosing this Pioneer DJ product.

Be sure to read this manual, the “Quick Start Guide” and the “Precautions for use” which are also included with this product. These documents include important information that you should understand before using the unit. In particular, be sure to read the IMPORTANT SAFETY INSTRUCTIONS.

- In this manual the names of buttons, knobs and terminals that appear on the product, and the names of buttons, menus etc. in the software on your PC/Mac or smartphone, are indicated within square brackets ([]). (e.g. **[File]**, **[CUE]** button)
- Please note that the software screens and their specifications, as well as the external appearance and specifications of the hardware, were still under development at the time this manual was created and may differ from the final specifications.
- Please note that depending on the operating system version, web browser settings, etc. operation may differ from the ways described in this manual.
- Please note that the language on the screens of the software described in this manual may differ from the language on your screen.

This manual mainly focuses on explaining the hardware functions of the unit.

For detailed instructions on using WeDJ for iPhone, see the tutorial in the application.

For detailed instructions on using rekordbox™, see the rekordbox Operating Instructions.

- **You can download the rekordbox Operating Instructions from rekordbox.com.
rekordbox.com/manual**

Contents

How to read this manual	2
Before you start.....	4
What's in the box	4
WeDJ for iPhone.....	5
Part names and functions (WeDJ for iPhone)	6
Connections (for iOS devices).....	12
Basic use (WeDJ for iPhone).....	17
Advanced use (WeDJ for iPhone)	22
Changing the settings in WeDJ for iPhone	38
rekordbox.....	40
Installing rekordbox.....	42
Part names and functions (rekordbox).....	45
Connections (for PC/Mac)	52
Basic use (rekordbox dj)	56
Advanced use (rekordbox dj).....	61
Changing the settings in rekordbox dj	69
Settings on the unit.....	71
Changing the Demo mode setting in Utilities mode.....	71
Changing the BLUETOOTH® MIDI device name.....	73
Additional information	75
Troubleshooting	75
Using the unit as a controller for other DJ applications	81
About trademarks and registered trademarks	82
Cautions on copyrights	84

Before you start

What's in the box

- USB cable
- Split cable
- Warranty (for some regions)¹
- Quick Start Guide (WeDJ/rekordbox)
- Quick Start Guide (djay)
- Quick Start Guide (edjing Mix)
- Precautions for use

¹ Only products in Europe.

Products in North America and Japan include warranty information in the "Precautions for use."

WeDJ for iPhone

WeDJ for iPhone is a DJ performance app you can download from the App Store. When you're using the app with the unit, you won't need to make in-app purchases.

- If you already have WeDJ for iPhone installed, update it to the latest version.

System requirements

iOS: iOS 12, 11, 10

Compatible models: iPhone XR, iPhone Xs, iPhone Xs Max, iPhone X, iPhone 8, iPhone 8 Plus, iPhone 7, iPhone 7 Plus, iPhone SE, iPhone 6s, iPhone 6s Plus, iPhone 6, iPhone 6 Plus, iPhone 5s, and iPod touch (6th generation)

- To check the latest information on system requirements, compatibility and supported operating systems, visit the Pioneer DJ support page below and click on the **[DDJ-200]** option in the **[DJ CONTROLLER]** section.

pioneerdj.com/en/support/software-information/

- Operation is not guaranteed on all iOS devices, even if the system requirements are met.
- Depending on power-saving settings and other conditions of the iOS device, WeDJ may perform poorly.
- Problems may occur with operation depending on the other software you use.
- For the latest system requirements for WeDJ for iPhone, check the App Store.
- You'll need an internet connection to access the App Store.

Part names and functions (WeDJ for iPhone)

Top panel

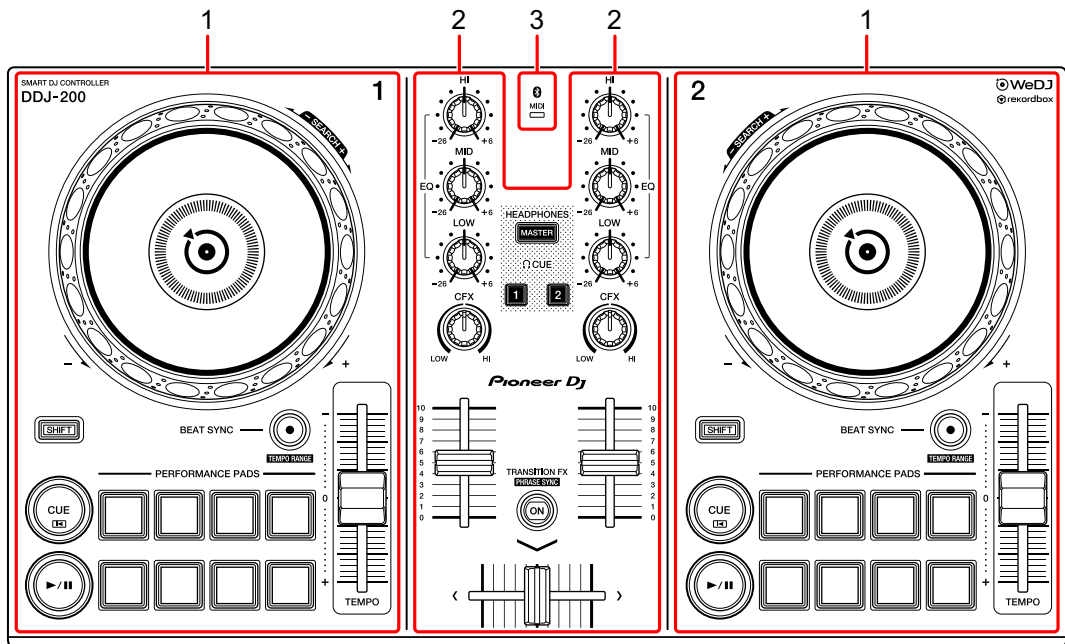

- 1 Deck sections (page 7)
- 2 Mixer section (page 9)
- 3 Bluetooth MIDI indicator (page 10)

Deck section

You can control two decks with the unit. There are controls and buttons on the left side to control deck 1 and on the right side to control deck 2.

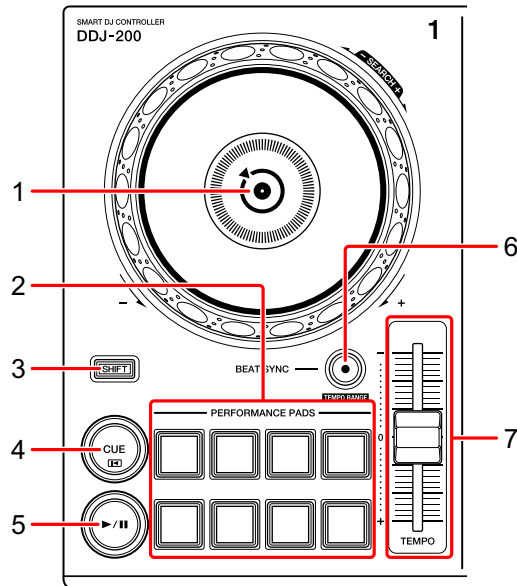

1 Jog wheel

Turn the top:
'Scratches' the track.

Turn the outer section:
Bends the pitch or 'Pitch Bend' (slows down or speeds up the track).

[SHIFT] + turn the top:
Fast forwards or fast reverses the track (turn clockwise or counter-clockwise).

2 Performance Pads

You can use Performance Pads to trigger various features.

➔ Read more: Using the Performance Pads (page 22)

3 SHIFT button

Press another button while holding the **[SHIFT]** button to use a different feature assigned to the button.

4 CUE button

Press:

Sets, plays and calls up a cue point.

- Press the button when the track is paused to set the cue point.
- Press the button when the track is playing to return to the cue point and pause. (Back Cue)
- Press the button and hold it after the track returns to the cue point and playback will continue until you release the button. (Cue Point Sampler)

[SHIFT] + press:

Returns the playback position to the beginning of the track.

5 PLAY/PAUSE ►/|| button

Plays/pauses a track.

6 BEAT SYNC button

Press:

Automatically synchronizes the tempos (BPM) and beatgrids with the other deck.

[SHIFT] + press:

Switches the range of **[TEMPO]** slider each time the button is pressed while holding the **[SHIFT]** button.

Switch between $\pm 6\%$ → $\pm 10\%$ → $\pm 16\%$ → [WIDE] → $\pm 6\%$

Hold down the **[BEAT SYNC]** buttons on deck 1 and deck 2 for at least one second at the same time:

The Bluetooth connection of the iOS device is canceled.

7 TEMPO slider

Adjusts the playing speed of the track.

Mixer section

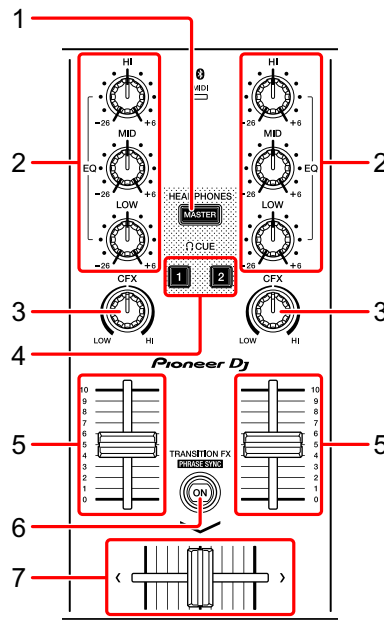

1 MASTER CUE button

Press:

Plays the master sound through your headphones when they're connected to the supplied split cable, which is plugged into the headphones output of your iOS device.

- Connect the headphones to the white plug of the split cable.
- ➔ Read more: Monitoring with headphones (page 20)

2 EQ (HI, MID, LOW) knobs

Boosts or reduces the relevant frequency for the selected channel.

3 CFX knob

Turns on the selected effect and changes the sound for the relevant channel. When the knob is set to the center position, the sound is unchanged.

4 Headphone CUE button

Press:

Plays the sound of the relevant channel (1 or 2) through your headphones when they're connected to the supplied split cable, which is plugged into the headphones output of your iOS device.

- Connect the headphones to the white plug of the split cable.
- ➔ Read more: Monitoring with headphones (page 20)

5 Channel fader

Adjusts the volume of the sound for each channel.

6 TRANSITION FX button

Press:

Turns on Transition FX.

- ➔ Read more: Using Transition FX (page 33)

[SHIFT] + press:

Turns on Phrase Sync.

- ➔ Read more: Using Phrase Sync (page 34)

7 Crossfader

Adjusts the sound balance between the left channel (deck 1) and right channel (deck 2).

Bluetooth MIDI indicator

Flashes: The iOS device is not connected via Bluetooth.

Lights up: The iOS device is connected via Bluetooth.

Turns off: The unit has recognized the connection with rekordbox using the USB cable.

- When using WeDJ for iPhone with the unit being powered via the USB port of your PC/Mac, do not start rekordbox on your PC/Mac.

Rear panel

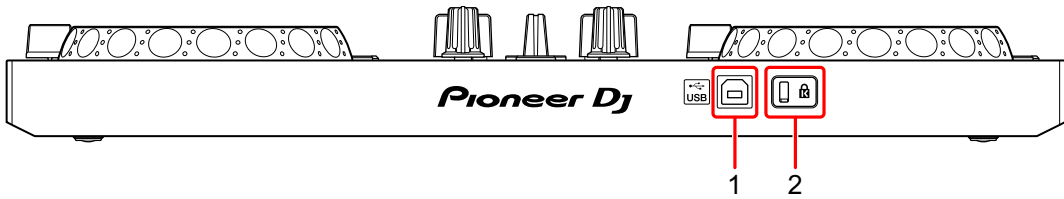

1 USB port

Connects to a USB power adapter (not supplied) or mobile battery (not supplied) via the supplied USB cable.

Also, you can connect to a USB port on your PC/Mac with the supplied USB cable to power the unit.

- Use a USB power adapter or mobile battery with DC +5 V and 500 mA or more.
- When powering the unit from a USB port on your PC/Mac, do not start rekordbox on your PC/Mac.
- Use a mobile battery which does not have a power-saving function. If you use a mobile battery with a power-saving function, it may cut power to the unit.

2 Kensington security slot

Connects a cable lock for security.

Connections (for iOS devices)

Power comes through the USB port. You can connect to the USB port on your PC/Mac or connect a USB power adapter or mobile battery to power the unit.

Use a USB power adapter or mobile battery with DC +5 V and 500 mA or more.

Use a mobile battery which does not have a power-saving function.

Use the USB cable supplied with this unit.

Connect the cable correctly after checking the position of the port on this unit.

Refer to the instruction manuals for components to be connected.

- Once connected with the unit, connect your PC/Mac to an AC power supply. (This applies when power is supplied to the unit through the USB port on your PC/Mac.)
- The unit can't be powered via your PC/Mac in the following situations:
 - Power supply capacity of the USB port on your PC/Mac is too low.
 - Your PC/Mac is connected with other USB devices.

Connecting to the USB port

Rear panel

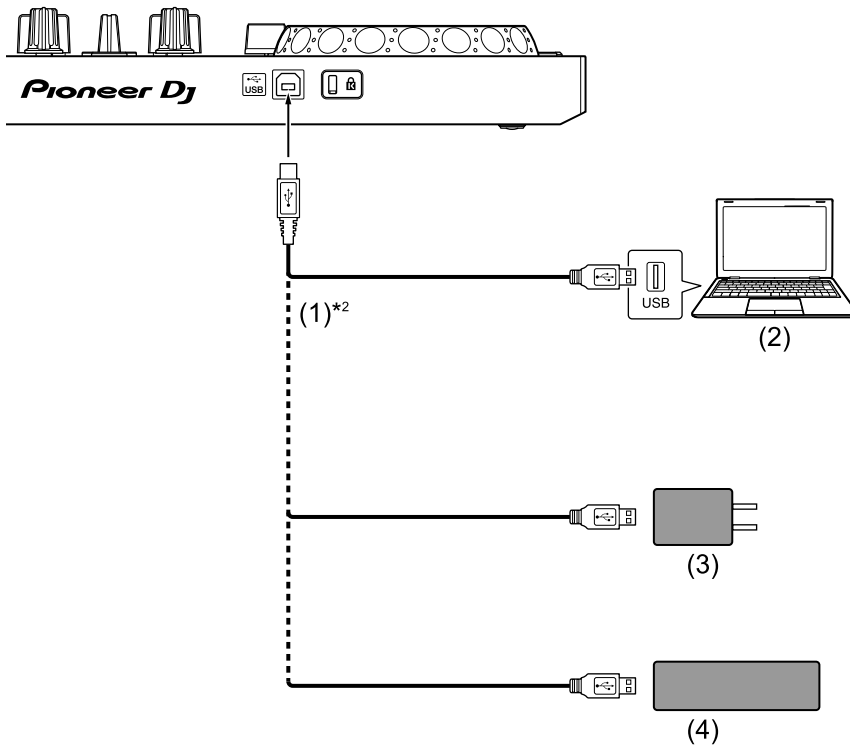

(1) USB cable (supplied), (2) PC/Mac*¹, (3) USB power adapter (not supplied), (4) mobile battery (not supplied)

*¹ If you want to power the unit via the USB port on your PC/Mac, turn on your PC/Mac.

*² To maintain performance, use the supplied USB cable.

Connecting an audio device (speaker) to the headphones jack of your iOS device

You can DJ with an iOS device and listen to your performance via its built-in speakers. However, if you use the supplied split cable, you can create an authentic DJ set-up with an external speaker(s) and headphones.

Connection example 1 (if the iOS device has a headphones output)

In this example, the master sound plays in stereo and there is no sound output to the headphones.

➡ Read more: Checking audio setup (page 18)

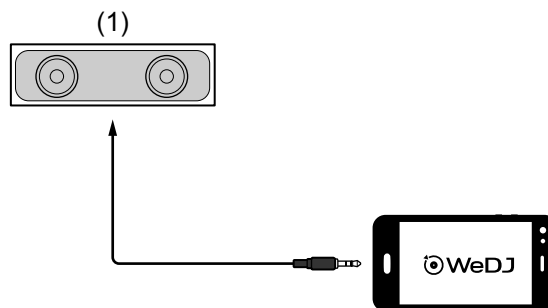

(1) Speaker with built-in amplifier, etc.*

* The audio cable is not supplied with the unit.

Connection example 2 (if the iOS device has a headphones output)

In this example, the master sound and the headphones monitor sound both play in mono.

➡ Read more: Checking audio setup (page 18)

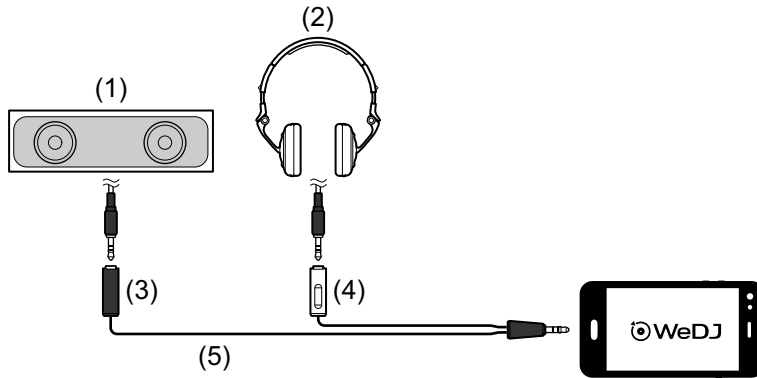

- (1) Speaker with built-in amplifier, etc.*,
- (2) Headphones,
- (3) Plug for the speaker with built-in amplifier, etc. (black),
- (4) Plug for the headphones (white),
- (5) Split cable (supplied)

* The audio cable is not supplied with this unit.

Connection example 3 (if the iOS device does not have a headphones output, such as iPhone Xs)

In this example, the master sound plays in stereo and there is no sound output to the headphones.

➡ Read more: Checking audio setup (page 18)

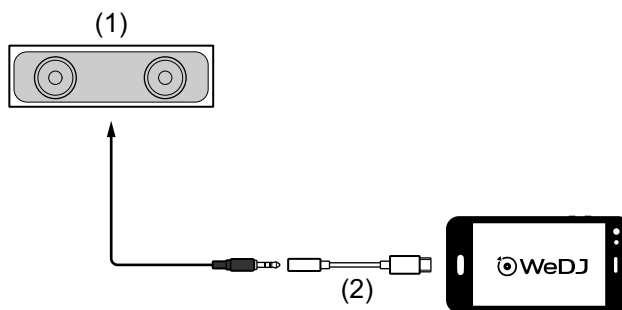

- (1) Speaker with built-in amplifier, etc.*,
- (2) Lightning - 3.5 mm headphones jack adapter (not supplied)

* The audio cable is not supplied with the unit.

Connection example 4 (if the iOS device does not have a headphones output, such as iPhone Xs)

In this example, the master sound and the headphones monitor sound both play in mono.

➡ Read more: Checking audio setup (page 18)

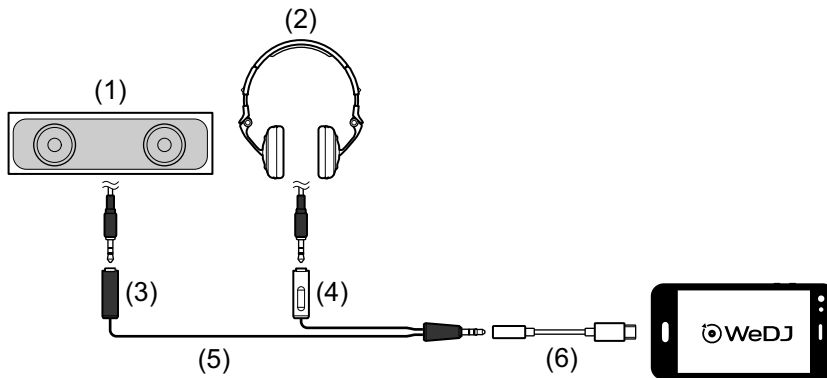

- (1) Speaker with built-in amplifier, etc.*, (2) Headphones,
(3) Plug for the speaker with built-in amplifier, etc. (black),
(4) Plug for the headphones (white), (5) Split cable (supplied),
(6) Lightning - 3.5 mm headphones jack adapter (not supplied)



* The audio cable is not supplied with this unit.

Turning on the iOS device, etc.

- 1 Turn on the iOS device.
- 2 Turn on the device(s) connected to the iOS device (speaker with built-in amplifier, etc.).

Basic use (WeDJ for iPhone)

Starting WeDJ for iPhone and connecting it to the unit

- 1 Tap  on your iOS device to start WeDJ for iPhone.
The tutorial screen may show.
The following steps may be different if you run the tutorial.
 - 2 Tap  on the main screen of WeDJ for iPhone.
The **[Settings]** screen is displayed.
 - 3 Tap **[Connect the DDJ-200]**.
 - 4 Tap **[DDJ-200]**.
The unit connects to your iOS device via Bluetooth.
When the connection is complete, the WeDJ logo and the unit's logo are displayed and the light of the Bluetooth MIDI indicator changes from being lit to flashing.
 - On the **[Connect the DDJ-200]** screen, **[DDJ-200_X]** may be displayed (X is a number from 1 to 16).
- ➔ Read more: Changing the BLUETOOTH® MIDI device name (page 73)

Checking audio setup

- 1 Tap  on the main screen of WeDJ for iPhone.
- 2 Tap **[Audio]** on the **[Settings]** screen.
To play both master sound and headphones monitor sound via the supplied split cable, turn on **[Split Output]**.
To play the master sound via your iOS device's built-in speaker, or to play it in stereo via a speaker with a built-in amplifier connected to your iOS device, without using the split cable, turn off **[Split Output]**.
 - Read more: Connecting an audio device (speaker) to the headphones jack of your iOS device (page 14)
 - Read more: Monitoring with headphones (page 20)
- 3 Go to the **[Settings]** screen, then tap **[Done]**.
The main screen of WeDJ for iPhone is displayed.

Loading a song or audio track onto a deck

- 1 Tap the area that shows the track title, near the top of the main screen of WeDJ for iPhone.
This opens the browse screen.



- 2 Tap the track you want to load.

This loads the track onto the deck.

Playing a track

This section explains how to play sound from deck 1 (left) as an example.

- 1 Set the positions of the controls as follows:
 - **[EQ (HI/MID/LOW)]** knobs: center position (12 o'clock)
 - **[CFX]** knob: center position
 - Channel fader: bottom position
 - Crossfader: center position
- 2 Press the **[PLAY/PAUSE ►/||]** button to play the track.

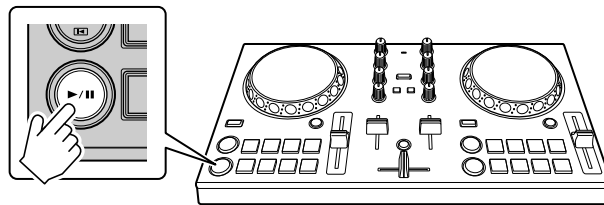

- 3 Move the channel fader to the top.

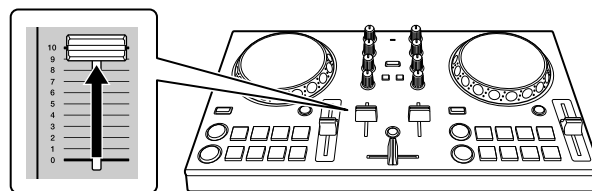

- 4 Tap  on the main screen of WeDJ for iPhone.
- 5 Tap **[Audio]** on the **[Settings]** screen.
- 6 Move the **[MASTER VOLUME]** slider on the **[Audio]** screen.
Adjust the volume for your iOS device's speaker, or the speaker connected to your iOS device, until you have a volume level you're happy with.

Monitoring with headphones

To monitor sound with your headphones, you need to use the supplied split cable.

➡ Read more: Connecting an audio device (speaker) to the headphones jack of your iOS device (page 14)

Also, you need to turn on **[Split Output]** in WeDJ for iPhone.

➡ Read more: Checking audio setup (page 18)

❖ Monitoring sound from a channel via headphones

The following example explains how to monitor sound from deck 1 (left).

- 1 Press the Headphone **[CUE]** button on channel 1.

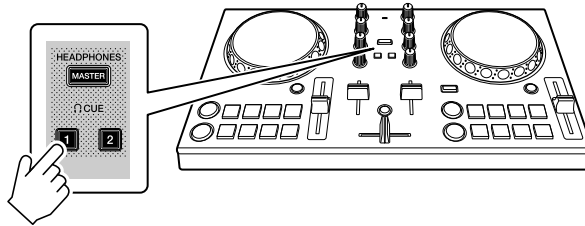

- 2 Tap  on the main screen of WeDJ for iPhone.
- 3 Tap **[Audio]** on the **[Settings]** screen.
- 4 Move the **[MIN]** / **[MAX]** slider under **[Split Output]** on the **[Audio]** screen.
Adjust the volume for the headphones monitoring sound until you have a level you're happy with.

❖ Monitoring the master sound with headphones

- 1 Press the **[MASTER CUE]** button.

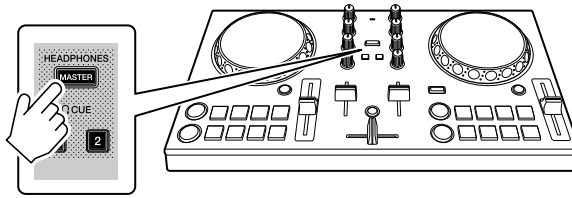

- 2 Tap  on the main screen of WeDJ for iPhone.
- 3 Tap **[Audio]** on the **[Settings]** screen.
- 4 Move the **[MIN]** / **[MAX]** slider under **[Split Output]** on the **[Audio]** screen.
Adjust the volume for the headphones monitoring sound until you have a level you're happy with.

Quitting the system

- 1 Quit WeDJ for iPhone.
- 2 Disconnect the USB cable to turn off the unit.

Advanced use (WeDJ for iPhone)

Using the Performance Pads

❖ Using Hot Cues

You can start playback instantly from the position where a Hot Cue is set. Loops can also be set and called up instantly.

- Up to 8 Hot Cue points can be set and saved for each track.

❖ Setting and calling up a Hot Cue

- 1 Tap **[HOT CUE]** on the main screen of WeDJ for iPhone.

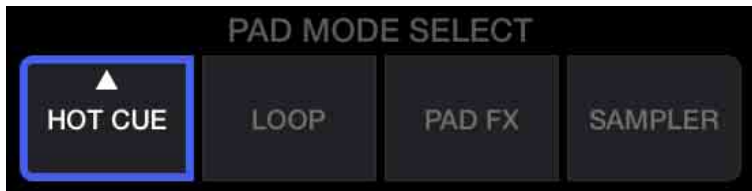

- 2 If the track is playing or paused, press a Performance Pad to set the Hot Cue point.

The Hot Cue points are set to Performance Pads as follows:

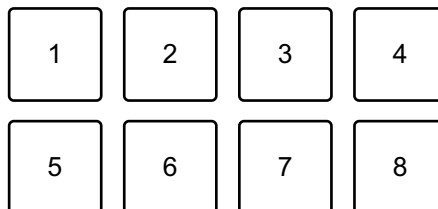

1: Hot Cue A, 2: Hot Cue B, 3: Hot Cue C, 4: Hot Cue D,
5: Hot Cue E, 6: Hot Cue F, 7: Hot Cue G, 8: Hot Cue H

- 3 Press a Performance Pad you've set a Hot Cue for. Playback starts from the Hot Cue point.

- You can clear Hot Cue points by pressing a Performance Pad while holding the **[SHIFT]** button.

❖ Setting and calling up Beat Loop

- 1 Tap **[LOOP]** on the main screen of WeDJ for iPhone.

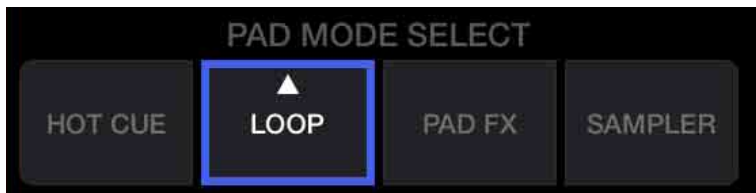

- 2 Tap **[LOOP]** again to display the **[LOOP]** panel.
- 3 Turn on Beat Loop mode.
When **[AUTO]** shows instead of **[MANUAL]** as it does in the following picture, tap **[AUTO]** to switch to Beat Loop mode.

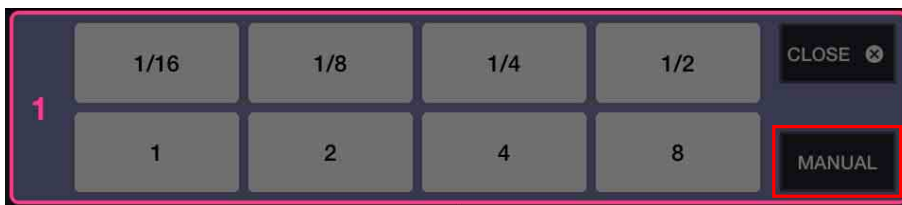

- 4 Press a Performance Pad during playback.
Loop playback starts with the number of beats set on the pad you pressed.
➡ Read more: Using Beat Loop (page 25)
- 5 Tap **[HOT CUE]** on the main screen of WeDJ for iPhone.

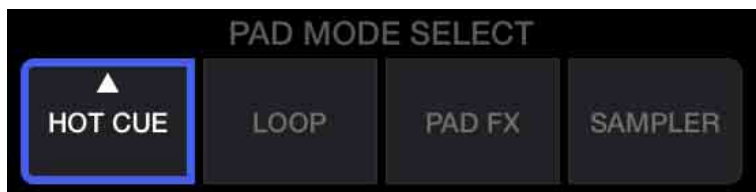

- 6 Press a Performance Pad to set a loop during loop playback.

7 Press the Performance Pad.

Loop playback starts from the Loop In point.

- You can clear the loop by pressing the Performance Pad while holding the **[SHIFT]** button.

❖ Setting and calling up Manual Loop

1 Tap **[LOOP]** on the main screen of WeDJ for iPhone.

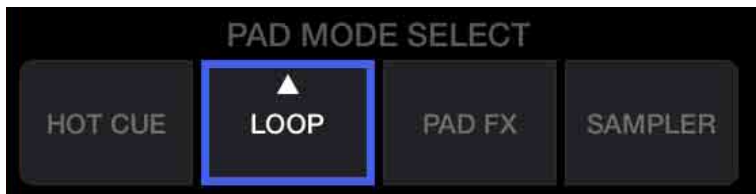

2 Tap **[LOOP]** again to display the **[LOOP]** panel.

3 Turn on Manual Loop mode.

When **[MANUAL]** shows instead of **[AUTO]** as it does in the following picture, tap **[MANUAL]** to switch to Manual Loop mode.



4 Press Performance Pad 1, then press Performance Pad 2.

Loop playback starts.

- ➡ Read more: Using Manual Loop (page 27)

5 Tap **[HOT CUE]** on the main screen of WeDJ for iPhone.

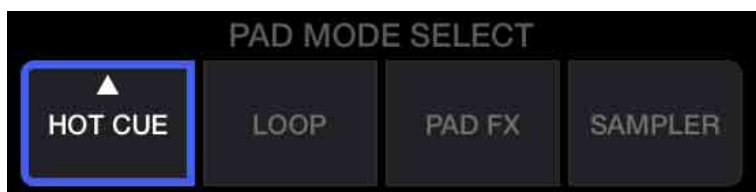

- 6 Press the Performance Pad to set a loop during loop playback.
- 7 Press the Performance Pad you've set a loop on.
Loop playback starts from the Loop In point.
 - You can clear the loop by pressing the Performance Pad while holding the **[SHIFT]** button.

Using Beat Loop

Press a Performance Pad while in Beat Loop mode to loop a set number of beats. The loop keeps playing after you remove your finger from the pad.

- 1 Tap **[LOOP]** on the main screen of WeDJ for iPhone.

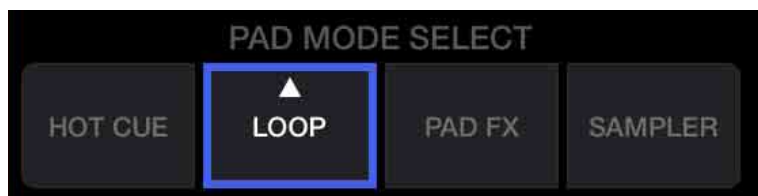

- 2 Tap **[LOOP]** again to display the **[LOOP]** panel.
- 3 Turn on Beat Loop mode.
When **[AUTO]** shows instead of **[MANUAL]** as it does in the following picture, tap **[AUTO]** to switch to Beat Loop mode.

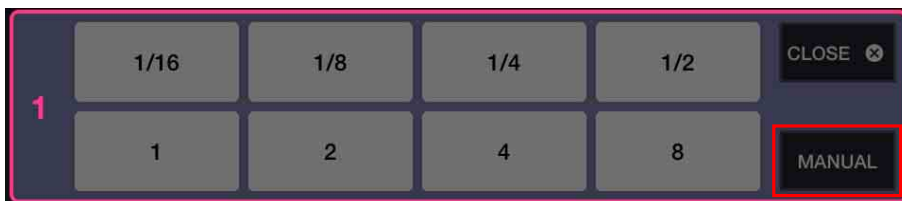

The number of beats set to the Performance Pads are as follows:

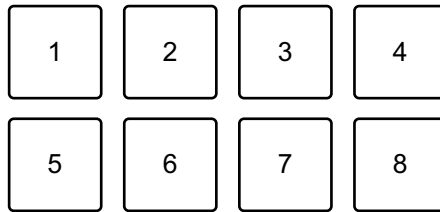

1: Beat Loop $1/16$ beat, 2: Beat Loop $1/8$ beat, 3: Beat Loop $1/4$ beat,
4: Beat Loop $1/2$ beat, 5: Beat Loop 1 beat, 6: Beat Loop 2 beats,
7: Beat Loop 4 beats, 8: Beat Loop 8 beats

4 Press a Performance Pad.

The loop plays with the number of beats set on that pad.

5 Press the same Performance Pad again.

Loop playback is canceled and the rest of the track continues to play.

Using Manual Loop

You can choose the section you want to loop.

- When the Quantize function is turned on, you might notice a slight delay as the loop synchronizes to the beat.

1 Tap **[LOOP]** on the main screen of WeDJ for iPhone.

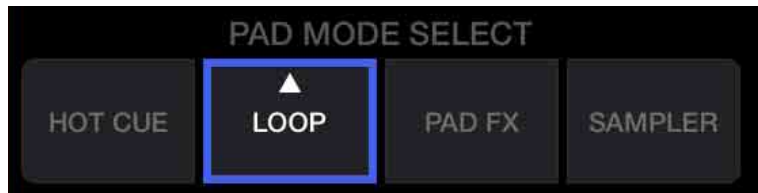

2 Tap **[LOOP]** again to display the **[LOOP]** panel.

3 Turn on Manual Loop mode on WeDJ for iPhone.

When **[MANUAL]** shows instead of **[AUTO]** as it does in the following picture, tap **[MANUAL]** to switch to Manual Loop mode.



Functions for Manual Loop are set to Performance Pads as follows:

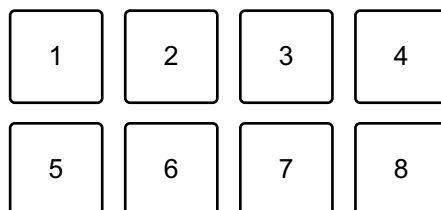

1: Setting Loop In point, 2: Setting Loop Out point, 3: Loop Exit / Reloop, 4: not used, 5: Loop Cutter, 6: Loop Double, 7: not used, 8: not used

- 4 Press Performance Pad 1 at the point you want to start looping (the Loop In Point).
- 5 Press Performance Pad 2 at the point you want the loop to end (the Loop Out Point).

❖ **Dividing the loop**

Press Performance Pad 5 while the loop is playing.
Each time you press the pad, the loop cuts in half.

❖ **Extending the loop**

Press Performance Pad 6 while the loop is playing.
Each time you press the pad, the loop doubles in length.

❖ **Canceling a loop**

Press Performance Pad 3 while the loop is playing.
When the Loop Out point is reached, the rest of the track plays without returning to the Loop In point.

- If you press Performance Pad 3 again, playback position returns to the Loop In point and the loop starts playing again.

Using Pad FX

You can add a wide range of effects to your performances simply by pressing and releasing the Performance Pads.

- 1 Tap **[PAD FX]** on the main screen of WeDJ for iPhone.

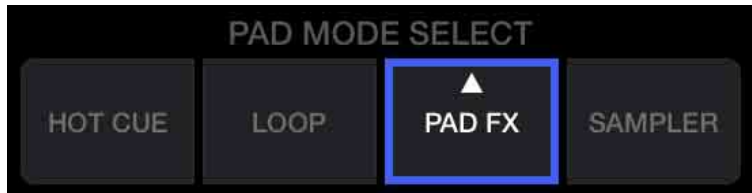

Effects are set to the Performance Pads as follows.

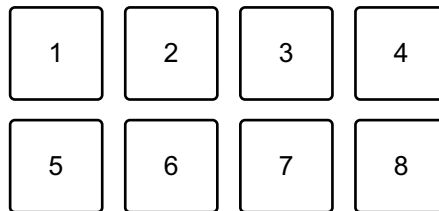

1: Effect 1, 2: Effect 2, 3: Effect 3, 4: Effect 4,
5: Effect 5, 6: Effect 6, 7: Effect 7, 8: Effect 8

- 2 Press and hold down a Performance Pad.
The effect turns on. The sound changes according to the type of effect and the number of beats in the settings assigned to that pad.
- 3 Release the Performance Pad.
The effect turns off.

❖ Using Release FX of Pad FX

You need to assign one of the Release FX to a Performance Pad in advance.

- 1 Press and hold down a Performance Pad that has an effect other than Release FX assigned to it.
The effect turns on.
- 2 Press the Performance Pad that has a Release FX assigned to it.
The effect turns off, and the Release FX is added.

Using the Sampler

You can use the Performance Pads to play sounds assigned to the Sampler slots.

- 1 Tap **[SAMPLER]** on the main screen of WeDJ for iPhone.

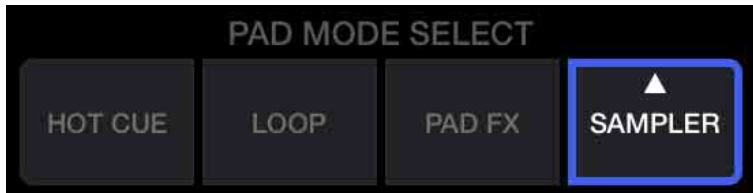

- 2 Tap **[SAMPLER]** again to display the **[SAMPLER]** panel.
- 3 Move the **[VOL.]** slider on the screen of WeDJ for iPhone to adjust the sampler volume to a level you're happy with.

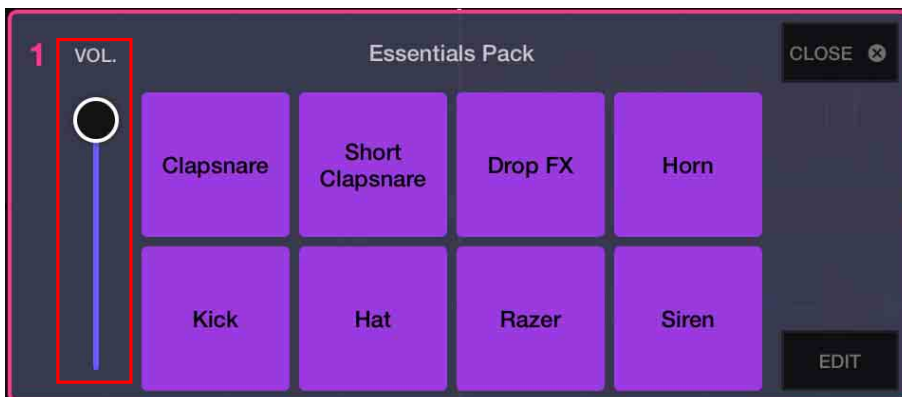

4 Press a Performance Pad.

The sound assigned to the relevant slot plays.

- Sampler slots are triggered by the Performance Pads as follows:

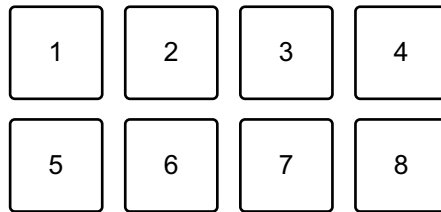

1: Slot 1, 2: Slot 2, 3: Slot 3, 4: Slot 4, 5: Slot 5, 6: Slot 6, 7: Slot 7, 8: Slot 8

5 While the Sampler is playing a sound, press the Performance Pad again.

The sound plays from the beginning again.

Using Transition FX

You can easily mix like a professional DJ with effects and scratches, simply by using the crossfader.

The following example explains how to transition from a track on deck 1 to a track on deck 2.

- 1 Set the positions of the controls as follows:
 - **[EQ (HI/MID/LOW)]** knobs: center position (12 o'clock)
 - **[CFX]** knob: center position
 - Channel fader: top position
 - Crossfader: left position
- 2 Load tracks onto deck 1 and deck 2, then play both. You'll hear the sound of the track on deck 1.
- 3 Press the **[BEAT SYNC]** button on the right side. The tempo and beatgrid of the track on deck 2 are automatically matched to deck 1.
- 4 Tap the **[TRANSITION FX]** selection button on the screen of WeDJ for iPhone to select a Transition FX type.

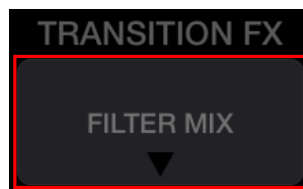

- 5 Press the **[TRANSITION FX]** button to turn on Transition FX.
- 6 Move the crossfader to the right. As the sound of deck 1 fades out, the sound of deck 2 fades in. The Transition FX is added while this is happening.

Using Phrase Sync

By matching the phrase start points of tracks on deck 1 and deck 2, you can perform a smooth mix.

Hold down the **[SHIFT]** button and press the **[TRANSITION FX]** button to match the closest phrase start points from the current playback position.

The countdown for the next phrase is displayed in the center of the screen.

The following example explains how to match the track playing on deck 1 to the track loaded on deck 2.

1 Set the positions of the controls as follows:

- **[EQ (HI/MID/LOW)]** knobs: center position (12 o'clock)
- **[CFX]** knob: center position
- Channel fader of deck 1: top position
- Channel fader of deck 2: bottom position
- Crossfader: center position

Load tracks onto deck 1 and deck 2, then play them both.

You'll hear the sound of the track on deck 1.

2 Press the **[BEAT SYNC]** button on the right side.

The tempo and beatgrid of the track on deck 2 are automatically changed to match deck 1.

3 Hold down the **[SHIFT]** button and press the **[TRANSITION FX]** button.

The playback position on deck 2 jumps so that the countdown value matches for deck 1 and deck 2.

4 To match the next phrase start point, move the channel fader of deck 2 to the top position and move the channel fader of deck 1 to the bottom position.

Recording

WeDJ for iPhone has a Recording feature that can record mixed sound.

To start recording, tap  at the top of the main screen of WeDJ for iPhone.

- Tap  again to stop recording.
- When recording has ended, the file is saved automatically.

Using streaming services

When you're using WeDJ for iPhone, you can play music from streaming services such as Beatport and SoundCloud.

Beatport

To use the Beatport streaming service with WeDJ for iPhone, you need to register to Beatport Link. Visit the Beatport website for more details.

<https://www.beatport.com/>

SoundCloud

To use the SoundCloud streaming service with WeDJ for iPhone, you need to register to SoundCloud Go+. Visit the SoundCloud website for more details.

<https://soundcloud.com/>

- 1 Tap the bottom left of the browse screen.

The library menu is displayed.

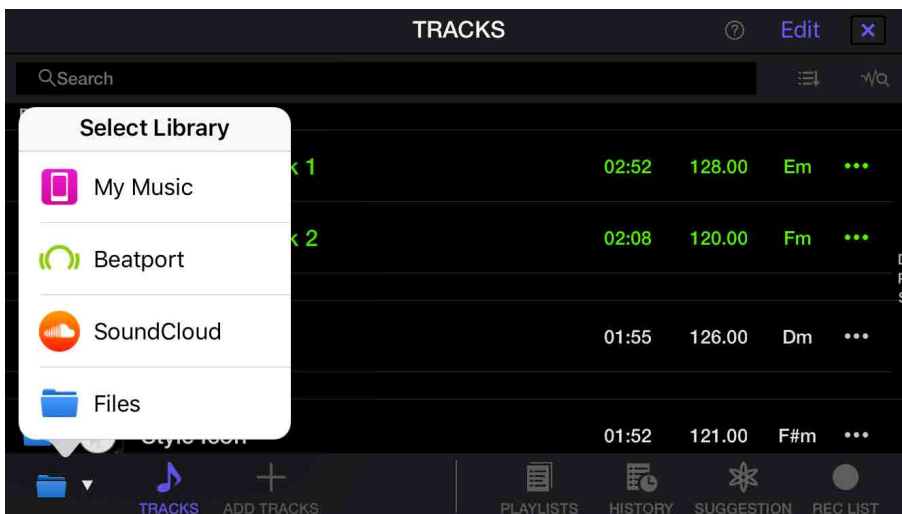

- 2 Select the streaming service you want to use.

The login screen is displayed. When you've successfully logged in, tracks from the streaming service are displayed on the browse screen.

- * When you're playing a track from Beatport or SoundCloud, you can't use the Recording feature of WeDJ for iPhone.

Changing the settings in WeDJ for iPhone

You can change the unit's settings in WeDJ for iPhone.

Changing the Demo mode setting

In normal conditions, if you don't use any of the features for a specified amount of time, this unit will enter Demo mode.

The amount of time can be set to 1 minute, 5 minutes or 10 minutes.

Demo mode can also be turned off.

- By default, Demo mode starts when you don't use any features for 10 minutes.
- When any knob or button on the unit is used during Demo mode, Demo mode is canceled.

- 1 Tap  on the main screen of WeDJ for iPhone.
- 2 Select **[Controller]** on the **[Settings]** screen.
- 3 Select **[Demo mode]** on the **[Settings]** screen to set Demo mode.
 - If the unit is not connected via Bluetooth, the unit's settings won't be displayed.

Changing the Back Spin Length setting

When using the unit's jog wheel to perform a Back Spin, you can make the Back Spin longer than the amount you rotate the jog wheel. The Back Spin length can be set to **[Short]**, **[Normal]** or **[Long]**.

- 1 Tap  on the main screen of WeDJ for iPhone.
- 2 Select **[Controller]** on the **[Settings]** screen.
- 3 Tap **[BACK SPIN LENGTH]** on the **[Controller]** screen to set the Back Spin Length.
 - If the unit is not connected via Bluetooth, the unit's settings won't be displayed.

rekordbox

- rekordbox

rekordbox is comprehensive music management software designed for DJs.

- rekordbox dj

rekordbox dj is the professional performance application for rekordbox.

You can use rekordbox dj by connecting the unit to your PC/Mac using the supplied USB cable. You don't need to buy a rekordbox dj license key.

To use rekordbox dj without connecting the unit, obtain a rekordbox dj license key via one of the methods below and enter it in the software.

- Buy a rekordbox dj license key at rekordbox.com.

- Start a subscription plan (monthly plan) at rekordbox.com.

For the latest information including download and rekordbox Operating Instructions, see the rekordbox website.

rekordbox.com

Minimum computer requirements

Supported operating systems	CPU and memory required
Mac: macOS Mojave 10.14 / macOS High Sierra 10.13 / macOS Sierra 10.12 (updated to the latest version)	Intel [®] processor Core™ i7, i5, i3 4 GB or more of RAM
Windows: Windows [®] 10 / Windows [®] 8.1 / Windows [®] 7 (latest service pack)	Intel [®] processor Core™ i7, i5, i3 4 GB or more of RAM

Others	
USB port	Your PC/Mac must have a USB 2.0 port to connect with the unit.
Display resolution	Resolution of 1280 × 768 or greater
Internet connection	You'll need an internet connection to register your rekordbox user account and download the software.

- Operation is not guaranteed on all PC/Mac models, even if the system requirements are met.
- Depending on power-saving settings and other conditions of the PC/Mac, the CPU and hard disk may not provide sufficient processing capabilities. For laptops in particular, make sure the PC/Mac is in the best condition to provide constant high-level performance when using rekordbox (for example by keeping the AC power connected).
- To use the internet, you need a separate contract with an internet service provider, which you may have to pay for.
- Operating system support always assumes you're using the latest point release for that version.
- Check the latest information on system requirements and compatibility in **[System requirements]** under **[Support]** at rekordbox.com.

Installing rekordbox

Getting started with rekordbox

If you're using rekordbox for the first time, or if you're currently using rekordbox Ver. 4.x or lower, download the latest version from rekordbox.com and install it in the following way.

If you already have rekordbox Ver. 5.x installed, update to the latest version using the Update Manager which shows when you start rekordbox.

- You are responsible for preparing your PC/Mac, network devices and other elements needed to connect to the internet.

Installing rekordbox

Procedures may differ depending on the operating system (OS) of your PC/Mac.

❖ Installing (Mac)

Do not connect the unit to your Mac using the USB cable until the installation is complete.

- Close all programs on your Mac.
 - 1 Unzip the downloaded rekordbox software file.
 - 2 Double-click the unzipped software file and start the installer.

- 3 Read the terms of the License Agreement carefully, then click **[Agree]** to continue.



- If you do not agree to the contents of the License Agreement, click **[Disagree]** to cancel the installation.

- 4 When the screen for completing the installation appears, click **[Close]** to end the installation.

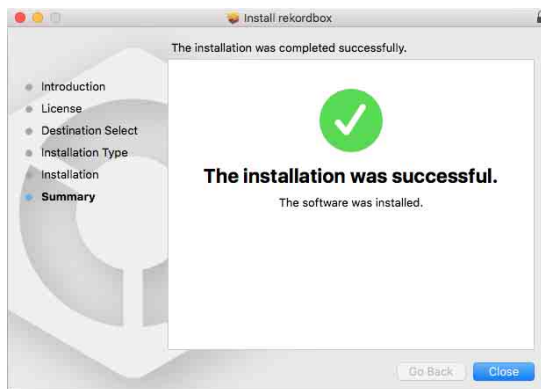

❖ Installing (Windows)

Do not connect the unit to your PC using the USB cable until the installation is complete.

- Log into your PC as administrator before starting the installation.
- Close all programs on your PC.

- 1 Unzip the downloaded rekordbox software file.

- 2 Double-click the unzipped software file and start the installer.
- 3 Read the terms of the License Agreement carefully and if you agree, select **[Agree]**, then click **[Next]**.

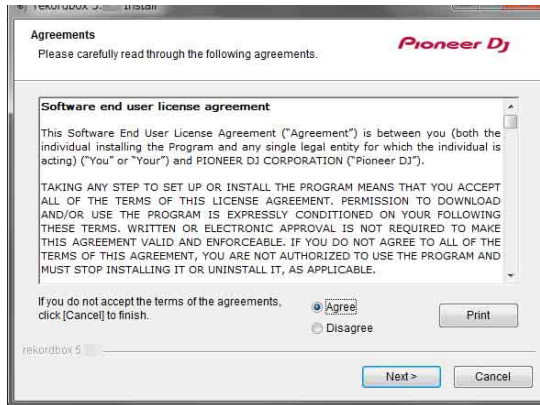

- If you do not agree to the contents of the license agreement, click **[Cancel]** to cancel the installation.
- After specifying the destination, the installation will start. When the installation is finished, a completion message will be displayed.

- 4 Click **[Finish]** to complete the installation.

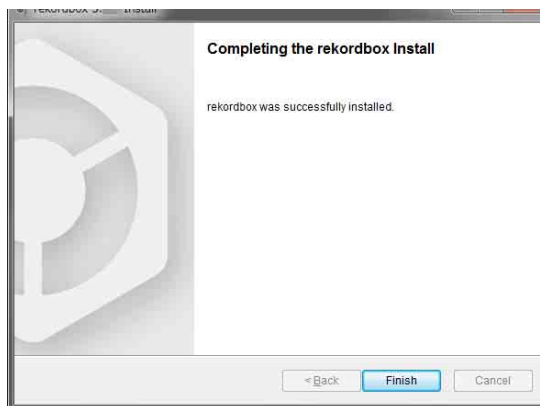

Installation is completed.

Part names and functions (rekordbox)

Top panel

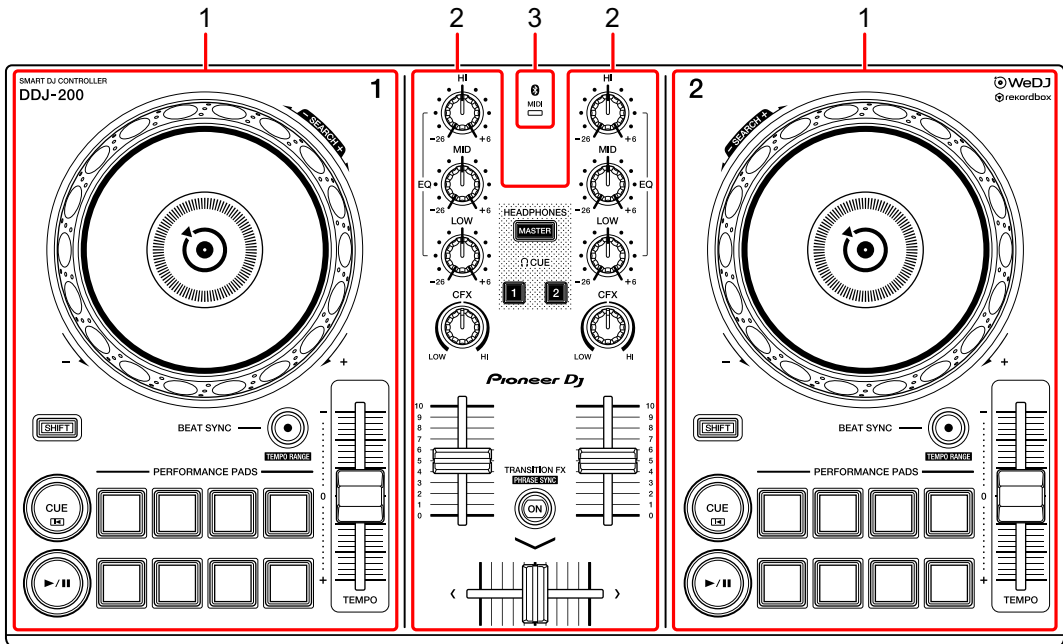

- 1 Deck sections (page 46)
- 2 Mixer section (page 48)
- 3 Bluetooth MIDI indicator (page 50)

Deck section

You can control two decks with the unit. There are controls and buttons on the left side to control deck 1 and on the right side to control deck 2.

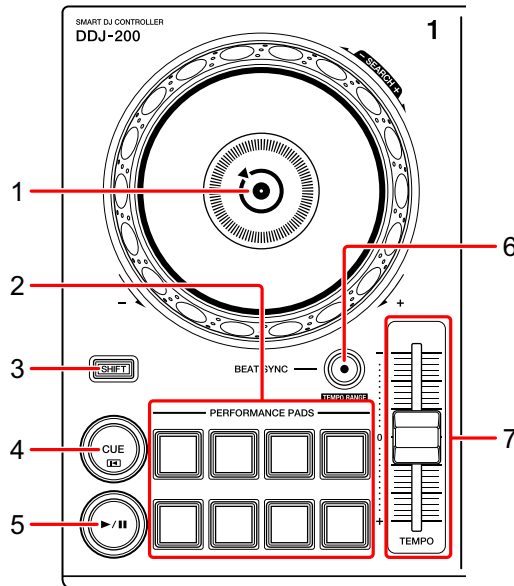

1 Jog wheel

Turn the top when VINYL mode is on:
‘Scratches’ the track.

Turn the outer section or turn the top when VINYL mode is off:
Bends the pitch or ‘Pitch Bend’ (slows down or speeds up the track).

- You can turn VINYL mode on and off using shortcut keys in rekordbox dj.

[SHIFT] + turn the top:

Fast forwards or fast reverses the track (turn clockwise or counter-clockwise).

2 Performance Pads

You can use Performance Pads to trigger various features.

- ➔ Read more: Using the Performance Pads (page 61)

3 **SHIFT button**

Press another button while holding the **[SHIFT]** button to use a different feature assigned to the button.

4 **CUE button**

Press:

Sets, plays and calls up a cue point.

- Press the button when the track is paused to set the cue point.
- Press the button when the track is playing to return to the cue point and pause. (Back Cue)
- Press the button and hold it after the track returns to the cue point and playback will continue until you release the button. (Cue Point Sampler)

[SHIFT] + press:

Returns the playback position to the beginning of the track.

5 **PLAY/PAUSE ►/|| button**

Plays/pauses a track.

6 **BEAT SYNC button**

Press:

Automatically synchronizes the tempos (BPM) and beatgrids with the deck set as the master.

[SHIFT] + press:

Switches the range of the **[TEMPO]** slider each time the button is pressed while holding the **[SHIFT]** button.

Switch between **[±6%]** → **[±10%]** → **[±16%]** → **[WIDE]** → **[±6%]**.

Hold down for at least one second:

Sets the deck as the master for synchronization.

7 **TEMPO slider**

Adjusts the playing speed of the track.

Mixer section

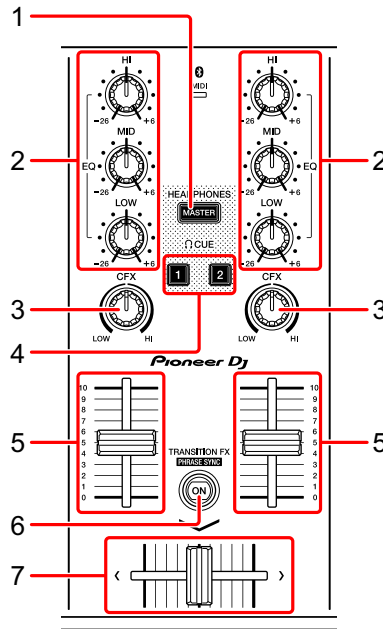

1 MASTER CUE button

Press:

Plays the master sound through your headphones when they're connected to the supplied split cable, which is plugged into the headphones output of your PC/Mac.

- Connect your headphones to the white plug of the split cable.
- ➔ Read more: Monitoring with headphones (page 59)

[SHIFT] + press:

Change the panel of rekordbox dj.

No panel → **[FX]** panel → **[SAMPLER]** panel → **[MIXER]** panel → **[REC]** panel → No panel

2 EQ (HI, MID, LOW) knobs

Boosts or reduces the relevant frequency for the selected channel.

3 CFX knob

Turns on the selected effect and changes the sound for the relevant channel.

When the knob is set to the center position, the sound is unchanged. For rekordbox, Filter is set as the default.

Turn counterclockwise: A cut-off frequency for the low-pass filter decreases gradually.

Turn clockwise: A cut-off frequency for the high-pass filter increases gradually.

4 Headphone CUE button

Press:

Plays the sound of the relevant channel through your headphones when they're connected to the supplied split cable, which is plugged into the headphones output of your PC/Mac.

- Connect the headphones to the white plug of the split cable.
- ➡ Read more: Monitoring with headphones (page 59)

[SHIFT] + press:

Hold the **[SHIFT]** button and tap the button to set the tempo of the respective deck in time with your tapping. (Tapping function)

5 Channel fader

Adjusts the volume of the sound for each channel.

6 TRANSITION FX button

This button is not used for rekordbox dj.

7 Crossfader

Adjusts the sound balance between the left channel (deck 1) and right channel (deck 2) depending on the crossfader curve setting.

Bluetooth MIDI indicator

Flashes: The smartphone is not connected via Bluetooth.

Lights up: The smartphone is connected via Bluetooth.

Turns off: This unit has recognized the connection with rekordbox via the USB cable.

- When using rekordbox dj, connect your PC/Mac to the unit via the supplied USB cable (see page 54). Do not connect your PC/Mac or smartphone to the unit via Bluetooth.

Rear panel

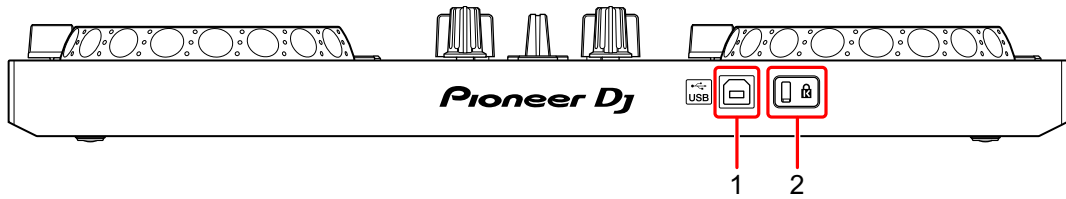

1 USB port

Connects to a PC/Mac.

- Connect this unit directly to your PC/Mac using the supplied USB cable.
- A USB hub can't be used.
- If your PC/Mac has only a USB Type-C port, you'll need to use a USB Type-C male to USB-A female cable.

2 Kensington security slot

Connect a cable lock for security.

Connections (for PC/Mac)

Power is supplied by via USB bus power. You can use the unit with a single connection to your PC/Mac.

Connect the cable correctly after checking the position of the port on this unit.

- Connect the unit and your PC/Mac directly using the supplied USB cable.
- A USB hub can't be used.
- Once connected with this unit, connect your PC/Mac to an AC power supply.
- This unit can't be used with USB bus power in the following situations:
 - The power supply capacity of the USB port on your PC/Mac is too low.
 - Your PC/Mac is connected with other devices.

Connecting an audio device (speaker) to the headphones jack of your PC/Mac

You can DJ and listen to your performance via the built-in speakers of your PC/Mac. However, if you use the supplied split cable, you can create an authentic DJ set-up with an external speaker(s) and headphones.

Connection example 1

In this example, the master sound plays in stereo and there is no sound output to the headphones.

➡ Read more: Checking audio setup (page 57)

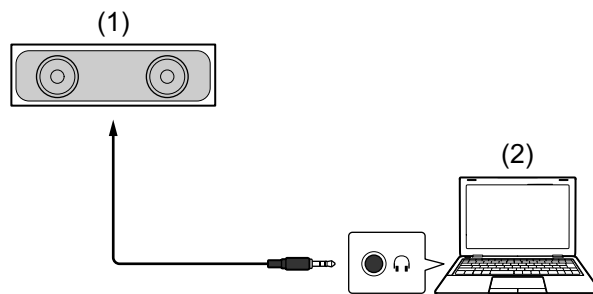

(1) Speaker with built-in amplifier, etc., (2) PC/Mac

* The audio cable is not supplied with the unit.

Connection example 2

In this example, the master sound and the headphones monitor sound both play in mono.

➔ Read more: Checking audio setup (page 57)

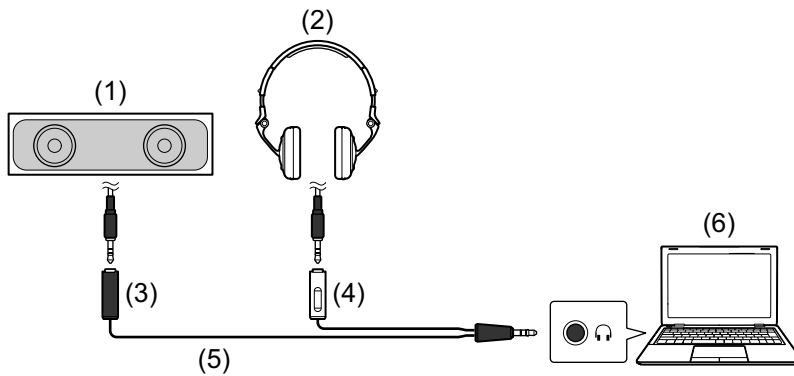

- (1) Speaker with built-in amplifier, etc.*, (2) Headphones,
 (3) Plug for the speaker with built-in amplifier, etc. (black),
 (4) Plug for headphones (white), (5) Split cable (supplied), (6) PC/Mac
 * The audio cable is not supplied with the unit.

Connecting your PC/Mac to the unit

- 1 Connect your PC/Mac to the unit via the USB cable.
 Make a direct connection with the supplied USB cable for optimum performance. A USB hub can't be used.

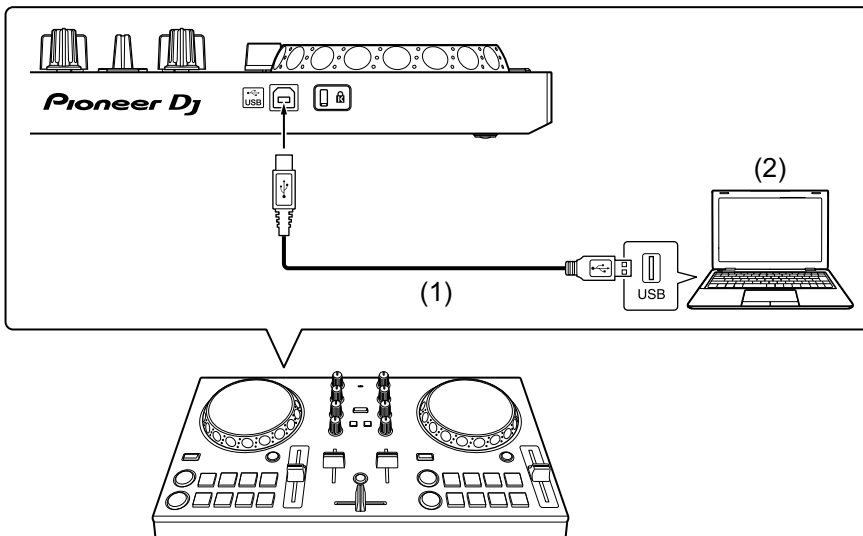

- (1) USB cable (supplied), (2) PC/Mac

- 2 Turn on your PC/Mac.
- 3 Turn on the device(s) (speakers with built-in amplifier, etc.) connected to your PC/Mac.

Basic use (rekordbox dj)

Starting rekordbox

You need to register an account to use rekordbox.

For details about account registration, click **[Manual]** under **[Support]** on the rekordbox website, then read: rekordbox Introduction.

rekordbox.com

For Mac

In Finder, open the **[Applications]** folder, then double-click the **[rekordbox 5]** > **[rekordbox.app]** icon.

For Windows 10

In the **[Start]** menu, click the **[rekordbox]** icon under **[Pioneer]**.



For Windows 8.1

In **[Apps view]**, click the **[rekordbox]** icon.

For Windows 7

In the Windows **[Start]** menu, click the **[rekordbox]** icon under **[All Programs]** > **[Pioneer]** > **[rekordbox X.X.X]**.

Checking audio setup

- To output the master sound and headphones monitor sound using the supplied split cable, turn on the  **[MONO SPLIT ON/OFF]** button at the top right of the rekordbox dj screen.
 - ➔ Read more: Connecting an audio device (speaker) to the headphones jack of your PC/Mac (page 53)
 - ➔ Read more: Monitoring with headphones (page 59)
- To play the master sound via your PC/Mac's built-in speaker, or to play it via a speaker with a built-in amplifier connected to your PC/Mac, without using the split cable, turn off the  **[MONO SPLIT ON/OFF]** button.

Adding music files into your Collection

The **[Collection]** screen contains a list of music files managed by rekordbox.

Add music files on your PC/Mac to your Collection so the software can analyze them and they can be used in rekordbox.

- 1 Click **[Collection]** on the tree view.

A list of tracks in your **[Collection]** is displayed.
- 2 Open Finder (Mac) or Explorer (Windows) and drag music files, or folders containing music files, into the track list.

Music files are added into **[Collection]** and analysis of waveform information for music files begins. Wait until analysis of all music files is complete.

Loading an audio track onto a deck

Select a track in **[Collection]** and drag it into the track information panel of a deck.

Playing a track

This section explains how to play sound from deck 1 (left) as an example.

- 1 Set the positions of the controls as follows:
 - **[EQ (HI/MID/LOW)]** knobs: center position (12 o'clock)
 - **[CFX]** knob: center position
 - Channel fader: bottom position
 - Crossfader: center position
- 2 Press the **[PLAY/PAUSE ►/III]** button to play the track.

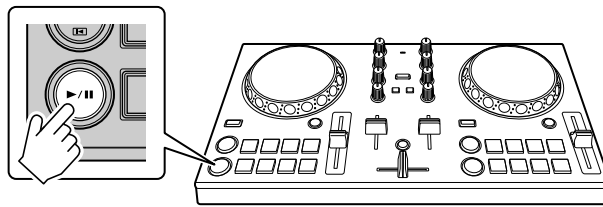

- 3 Move the channel fader to the top.

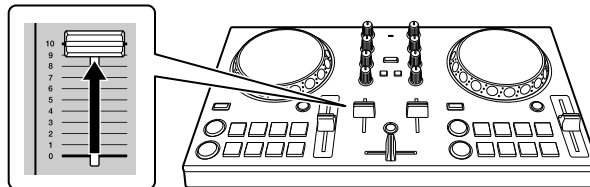

- 4 Adjust the volume on your PC/Mac.

Turn  **[Master Volume]** in rekordbox dj and adjust the volume of your PC/Mac's built-in speakers, or your connected speaker with a built-in amplifier, until you find a volume level you're happy with.

 - If the volume doesn't increase when you turn  **[Master Volume]**, adjust the volume of your PC/Mac's built-in speaker.

Monitoring with headphones

To monitor sound with your headphones, you need to use the supplied split cable.

➔ Read more: Connecting an audio device (speaker) to the headphones jack of your PC/Mac (page 53)

Also, you need to turn on the  **[MONO SPLIT ON/OFF]** button in rekordbox dj.

➔ Read more: Checking audio setup (page 57)

❖ Monitoring sound from a channel via headphones

The following example explains how to monitor sound from deck 1 (left).

- 1 Mark the **[MIXER]** check box at the top of the rekordbox dj screen. The **[MIXER]** panel is displayed.



- 2 Press the Headphone **[CUE]** button on channel 1.

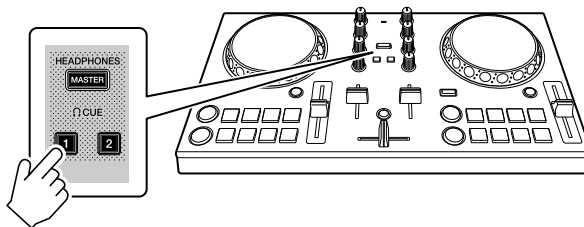

- 3 Adjust the  **[HEADPHONES LEVEL]** knob on the **[MIXER]** panel to adjust the volume for monitoring with headphones.

❖ Monitoring the master sound with the headphones

- 1 Mark the **[MIXER]** check box at the top of the rekordbox dj screen. The **[MIXER]** panel is displayed.



- 2 Press the **[MASTER CUE]** button.

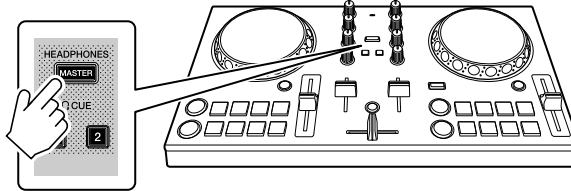

- 3 Adjust the  **[HEADPHONES LEVEL]** knob on the **[MIXER]** panel to adjust the volume for monitoring with headphones.

Quitting the system

- 1 Quit rekordbox.
- 2 Disconnect the USB cable to turn off the unit.

Advanced use (rekordbox dj)

Using the Performance Pads

❖ Using Hot Cues

You can start playback instantly from the position where a Hot Cue is set. Beat Loops can also be set and called up instantly.

- Up to 16 Hot Cue points can be set and saved for each track in rekordbox dj. On the unit, up to 8 hot cue points can be set and saved per track.

❖ Setting and calling up a Hot Cue

- 1 Click **[HOT CUE]** at the bottom of the rekordbox dj screen to enter **[HOT CUE]** mode.



- 2 If the track is playing or paused, press a Performance Pad to set the Hot Cue point.

The Hot Cue points are set to Performance Pads as follows:

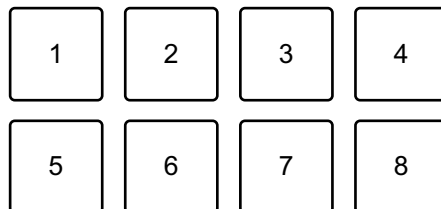

1: Hot Cue A, 2: Hot Cue B, 3: Hot Cue C, 4: Hot Cue D,
5: Hot Cue E, 6: Hot Cue F, 7: Hot Cue G, 8: Hot Cue H

- 3 Press a Performance Pad you've set a Hot Cue for. Playback starts from the Hot Cue point.

- You can clear Hot Cue points by pressing a Performance Pad while holding the **[SHIFT]** button.

❖ Setting and calling up Beat Loop

- 1 Click **[BEAT LOOP]** at the bottom of the rekordbox dj screen to enter **[BEAT LOOP]** mode.



- 2 Press a Performance Pad during playback.
Loop playback starts with the number of beats set on the pad you pressed.
➔ Read more: Using Beat Loop (page 63)
- 3 Click **[HOT CUE]** at the bottom of the rekordbox dj screen to enter **[HOT CUE]** mode.



- 4 Press a Performance Pad to set a loop during loop playback.
- 5 Press the Performance Pad.
Loop playback starts from the Loop In point.
 - You can clear the loop by pressing the Performance Pad while holding the **[SHIFT]** button.

Using Beat Loop

Press a Performance Pad while in Beat Loop mode to loop a set number of beats. The loop keeps playing after you remove your finger from the pad.

- 1 Click **[BEAT LOOP]** at the bottom of the rekordbox dj screen to enter **[BEAT LOOP]** mode.



The number of beats set to the Performance Pads are as follows:

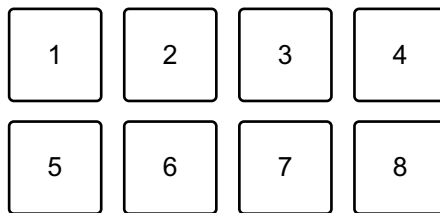

1: Beat Loop 1/4 beat, 2: Beat Loop 1/2 beat, 3: Beat Loop 1 beat,
4: Beat Loop 2 beats, 5: Beat Loop 4 beats, 6: Beat Loop 8 beats,
7: Beat Loop 16 beats, 8: Beat Loop 32 beats

- 2 Press a Performance Pad.
The loop plays with the number of beats set on that pad.
- 3 Press the same Performance Pad again.
Loop playback is canceled and the rest of the track continues to play.

Using Pad FX

You can add a wide range of effects to your performances simply by pressing and releasing the Performance Pads.

- 1 Click **[PAD FX 1]** at the bottom of the rekordbox dj screen to enter **[PAD FX 1]** mode.



Effects are set to Performance Pads as follows.

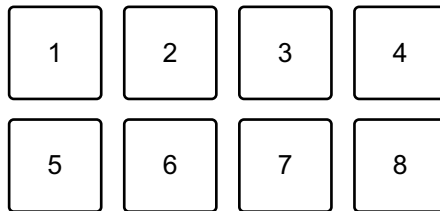

1: Effect A, 2: Effect B, 3: Effect C, 4: Effect D, 5: Effect E, 6: Effect F,
7: Effect G, 8: Effect H

- 2 Press and hold down a Performance Pad.
The effect turns on. The sound changes according to the type of effect and the number of beats in the settings assigned to that pad.
- 3 Release the Performance Pad.
The effect turns off.

❖ Using Release FX of Pad FX

You need to assign the Release FX to a Performance Pad in advance.

- 1 Press and hold down a Performance Pad that has an effect other than Release FX assigned to it.
The effect turns on.

- 2 Press the Performance Pad that has a Release FX assigned to it. The effect turns off, and the Release FX is added.

Using the Sampler

You can use the Performance Pads to play tracks or sounds assigned to the Sampler slots.

❖ Preparing to use the Sampler

Mark the **[SAMPLER]** check box at the top of the rekordbox dj screen.

- The **[SAMPLER]** panel is displayed.



❖ Loading a track into a Sampler slot

- 1 Click **[SAMPLER]** at the bottom of the rekordbox dj screen to enter **[SAMPLER]** mode.



- 2 Click the button at the right of **[BANK]** on the **[SAMPLER]** panel to change the Sampler bank.



In rekordbox dj, the sampler has 4 banks, and each bank has 16 slots.

- 3 Select a track from the track list to load into the Sampler slot.
- 4 Press a Performance Pad while holding the **[SHIFT]** button. The selected track is loaded into the Sampler slot.
 - Loading by overwriting a Sampler slot that's already loaded may not be possible depending on the **[Preferences]** settings in rekordbox.

❖ Playing Sampler tracks with Performance Pads

- 1 Click **[SAMPLER]** at the bottom of the rekordbox dj screen to enter **[SAMPLER]** mode.



- 2 Click the button at the right of **[BANK]** on the **[SAMPLER]** panel to change the Sampler bank.
- 3 Turn  **[GAIN]** on the **[SAMPLER]** panel to adjust the Sampler volume.
- 4 Press a Performance Pad.
The track or sound assigned to the relevant slot is played.
 - Sampler slots are set to Performance Pads as follows. (The slots in brackets are for when Pad mode of deck 2 is set to Sampler mode.)

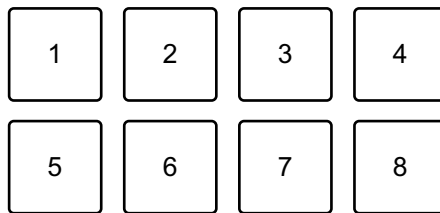

1: Slot 1 (slot 9), 2: Slot 2 (slot 10), 3: Slot 3 (slot 11), 4: Slot 4 (slot 12),
5: Slot 5 (slot 13), 6: Slot 6 (slot 14), 7: Slot 7 (slot 15), 8: Slot 8 (slot 16)

- 5 During Sampler playback, press the Performance Pad again.
The sound plays from the beginning again.
- 6 Press a Performance Pad while holding the **[SHIFT]** button during Sampler playback.
The sound of the slot that is currently playing stops.

Using Fader Start

❖ Using Channel Fader Start

- 1 Set the cue point.

Pause the track at the position you want to start playback from, then press the **[CUE]** button on that deck.

- 2 While holding the **[SHIFT]** button, move the channel fader from the bottom to the top.

Playback starts from the cue point.

- If you move the channel fader back to the bottom while holding the **[SHIFT]** button during playback, the track instantly jumps back to the cue point and playback pauses. (Back Cue)

When no cue point is set, playback starts from the beginning of the track.

❖ Using Crossfader Start

- 1 Set the cue point.

Pause the track at the position you want to start playback from, then press the **[CUE]** button on that deck.

- 2 Move the crossfader to the left edge or right edge.

If you want to use Crossfader Start to trigger playback on channel 2, set the crossfader to the left edge, and vice versa.

- 3 Hold the **[SHIFT]** button and move the crossfader towards the opposite edge from where it's set.

Playback of the track starts from the cue point.

- If you hold the **[SHIFT]** button during playback and move the crossfader back to the edge where you started from, the playback position instantly jumps back to the cue point and pauses. (Back Cue)

When no cue point is set, playback starts from the beginning of the track.

Analyzing tracks

Track analysis starts when you drag and drop a music file, or a folder containing music files, to the Track List in rekordbox.

- If a track is loaded to a deck before analysis is complete, it may take some time to display BPM and waveform.
 - Depending on the number of tracks, analysis may take some time.
-



Recording

rekordbox has a Recording feature that can record mixed sound. For detailed instructions on recording, see: “rekordbox Operating Instructions.”

- 1 Mark the **[REC]** check box at the top of the rekordbox dj screen.



The **[REC]** panel is displayed.

- 2 Click  on the **[REC]** panel in rekordbox dj to start recording.
 - If you click  again, recording stops.
 - When recording is completed, the file is automatically saved.
 - You can change the saving destination of the file in the **[Preferences]** > **[Controller]** > **[Recordings]** tab of rekordbox.

Changing the settings in rekordbox dj

You can change the settings of the unit in rekordbox dj.

Changing the Demo mode setting

In normal conditions, if you don't use any of the features for a specified amount of time, the unit will enter Demo mode.

The amount of time can be set to 1 minute, 5 minutes or 10 minutes.

Demo mode can also be turned off.

- By default, Demo mode starts when you don't use any features for 10 minutes.
- When any knob or button on the unit is used during Demo mode, Demo mode is canceled.

- 1 Click  on the rekordbox dj screen.
- 2 Select **[Controller]** on the **[Preferences]** screen, then select the **[DDJ-200]** tab.
- 3 Set Demo mode in **[Demo/Screen saver]**.
 - If the unit is not connected via the USB cable, the unit's settings won't be displayed.

Changing the Back Spin Length setting

When using the unit's jog wheel to perform a Back Spin, you can make the Back Spin longer than the amount you rotate the jog wheel. The Back Spin length can be set to **[Short]**, **[Normal]** or **[Long]**.

- 1 Click  on the rekordbox dj screen.
- 2 Select **[Controller]** on the **[Preferences]** screen, then select the **[Deck]** tab.
- 3 Set the Back Spin length on **[Back Spin Length]**.
 - If the unit is not connected via the USB cable, the unit's settings won't be displayed.

Changing the setting of Fader Start

When Fader Start is switched on, you can automatically start playback or move to a cue point (Back Cue) by moving a channel fader or the crossfader. Fader Start can also be switched off.

- 1 Click  on the rekordbox dj screen.
- 2 Select **[Controller]** on the **[Preferences]** screen, then select the **[Mixer]** tab.
- 3 Set **[Activate the fader start when moving a channel fader or the cross fader while pressing the SHIFT button]** to use Fader Start.
 - If the unit is not connected via the USB cable, the unit's settings won't be displayed.

Settings on the unit

Changing the Demo mode setting in Utilities mode

You can change the Demo mode setting in Utilities mode of the unit.

- The Demo mode setting is also available on WeDJ and rekordbox dj.

➡ Read more: Changing the settings in WeDJ for iPhone (page 38)

➡ Read more: Changing the settings in rekordbox dj (page 69)

If you launch Utilities mode while a DJ application is open, the set status may not display properly.

- 1 Disconnect the USB cable from the device supplying power to the unit (USB power adapter, PC/Mac, etc.).
- 2 Hold both the **[SHIFT]** and **[PLAY/PAUSE ►/||]** buttons on the left deck and connect the USB cable to the device supplying the power to the unit.

Utilities mode launches.

- 3 Change the Demo mode setting.

In normal conditions, if you don't use any of the features for a specified amount of time, the unit will enter Demo mode.

The amount of time can be set to 1 minute, 5 minutes or 10 minutes.

Demo mode can also be turned off.

- By default, Demo mode starts when you don't use any features for 10 minutes.
- When any knob or button on the unit is used during Demo mode, Demo mode is canceled.

Settings on the unit

Press the Performance Pads on deck 1 (left) to change the Demo mode setting.

The set value is indicated by which pad is lit.

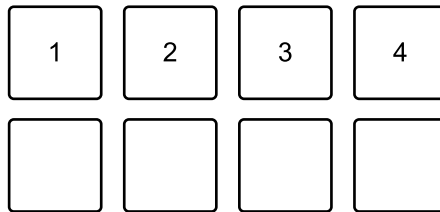

1: Demo mode is switched off.

2: Demo mode starts when you don't use the unit for 1 minute.

3: Demo mode starts when you don't use the unit for 5 minutes.

4: Demo mode starts when you don't use the unit for 10 minutes.

- After changing the setting, the setting is saved. While saving the setting, the bottom row of Performance Pads on the left deck flashes. In this case, wait until these pads change from flashing to lit. If the USB cable is disconnected while the pads are flashing, the setting may not be saved.

4 Disconnect the USB cable from the device supplying power to this unit.

Utilities mode is exited.

Changing the BLUETOOTH® MIDI device name

Before you potentially use other units, you can set the unit to be identified by your smartphone.

You can change the Bluetooth MIDI device name displayed for the Bluetooth connection between the unit and your smartphone.

- The Bluetooth MIDI device name setting can't be saved.
- 1 Disconnect the USB cable from the device supplying power to the unit (USB power adapter, PC/Mac, etc.).
 - 2 Hold down the relevant pad on the left or right deck and connect the USB cable to the device supplying power to the unit.

The relationship between Bluetooth MIDI device names and Performance Pads is as follows.

For deck 1

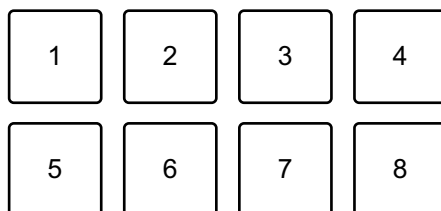

1: DDJ-200_1, 2: DDJ-200_2, 3: DDJ-200_3, 4: DDJ-200_4,
5: DDJ-200_5, 6: DDJ-200_6, 7: DDJ-200_7, 8: DDJ-200_8

For deck 2

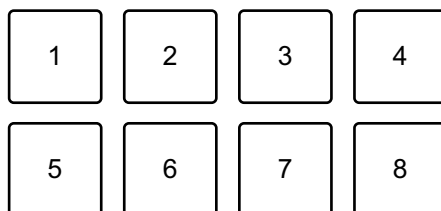

1: DDJ-200_9, 2: DDJ-200_10, 3: DDJ-200_11, 4: DDJ-200_12,
5: DDJ-200_13, 6: DDJ-200_14, 7: DDJ-200_15, 8: DDJ-200_16

Settings on the unit

3 Connect WeDJ for iPhone to the unit.

➔ Read more: Starting WeDJ for iPhone and connecting it to the unit (page 17)

Additional information

Troubleshooting

If you think something is wrong with the unit, check the information below and refer to the **[FAQ]** for the DDJ-200 on the Pioneer DJ website.

pioneerdj.com/support/

Additionally, check **[Support]** > **[FAQ]** on rekordbox.com.

Sometimes, the problem may be caused by another component.

Inspect the other components and electrical appliances you're using and refer to their manuals and FAQ if necessary. If you can't solve the problem, ask your nearest Pioneer DJ authorized service center, or your dealer, to carry out repair work.

- The unit may not work properly if it's subjected to static electricity or other external influences. In this case, turn off the unit and on again to restore proper operation.

Power

❖ The unit does not power up.

- When using WeDJ for iPhone, see: Connections (for iOS devices) (page 12).
- When using rekordbox on a PC/Mac, see: Connections (for PC/Mac) (page 52).

❖ The unit powers down arbitrarily.

- Use a mobile battery which does not have a power-saving function. The mobile battery should be DC +5 V and 500 mA or more.

Connection

- ❖ **The unit is not recognized by a smartphone.**
 - When using an iOS device, see: Starting WeDJ for iPhone and connecting it to the unit (page 17).
 - When this unit is connected to your PC/Mac using the USB cable and rekordbox is started on it, close rekordbox.

- ❖ **Bluetooth connection cannot be established. / Bluetooth connection is interrupted.**
 - If devices generating electromagnetic waves in the 2.4 GHz band (such as a microwave oven, wireless LAN or another Bluetooth device) are located nearby, move them away from the unit or stop using them.
 - If your smartphone is far away, move it closer to the unit. If there is a wall, obstacle, etc. which may be interrupting the connection, move your smartphone or the unit.

- ❖ **Sound outputs from only one channel of the headphones or the speaker with built-in amplifier, etc. connected to the headphones jack of your smartphone.**
 - When using an iOS device, see: Checking audio setup (page 18).

- ❖ **The volume is low for the headphones, or speaker with built-in amplifier, etc. connected to the headphones jack of your smartphone.**
 - Adjust the volume on your smartphone.
 - Check the external input setting and volume on the powered amplifier or speaker with built-in amplifier, etc.
 - Check your smartphone is correctly connected to the headphones/speaker with built-in amplifier, etc. If you're using a mono cable and sound is not output, use a stereo cable.

Additional information

- When using an iOS device, see: Playing a track (page 19).
- ❖ **Monitoring with headphones is disabled even when using the split cable to connect the headphones to your PC/Mac.**
 - See: Connecting an audio device (speaker) to the headphones jack of your PC/Mac (page 53).
 - See: Checking audio setup (page 57).
 - See: Monitoring with headphones (page 59).
- ❖ **The volume is low/sound is not output via the headphones while using rekordbox on a PC/Mac.**
 - See: Monitoring with headphones (page 59).

rekordbox dj

❖ rekordbox dj becomes unstable.

- Update the rekordbox to the latest version. See: Installing rekordbox (page 42).
- Quit any other open applications on your PC/Mac. If operation remains unstable, try disabling the wireless network or other wireless connections, antivirus software, screen saver, low power mode, etc.
- If another USB device is connected to your PC/Mac, disconnect it.
- If you're using battery power for your laptop, connect the laptop to an AC power supply.

Others

❖ **The jog wheel doesn't respond to touch.**

- An electrostatic system is used for touch detection in the jog wheels of the unit. If the jog wheel is dirty or you have hand cream on your hands, the jog wheel might not detect touch properly. When cleaning the jog wheel, dry-wipe it with a soft cloth. If it's very dirty, prepare a 5:1 or 6:1 solution of water and neutral detergent, soak a soft cloth in the solution and wring it out well, then clean the jog wheel and wipe it with a dry cloth.
- If touching the jog wheel while touching another metal part of the unit makes the jog wheel work, it's possible that the unit is being affected by another device connected to the unit. Review the connection environment (location, ground connection status, etc.) of the devices (PC/Mac, etc.) connected to the unit.

❖ **The indicator flashes and operation is strange.**

- If the unit behaves unusually or doesn't turn on, disconnect the USB cable, wait a while, then reconnect the USB cable to turn on the unit.

Using the unit as a controller for other DJ applications

The unit also outputs operating data for the buttons and knobs in MIDI format. If you connect a PC/Mac with a built-in MIDI compatible DJ application via the USB cable, you can control the DJ application with the unit. (You need to set MIDI details in the DJ application.)

- For details, see your DJ application's user guide.

About MIDI messages

For details on this unit's MIDI messages, see: "List of MIDI Messages".

- You can find the List of MIDI Messages from the Pioneer DJ website: pioneerdj.com/

About the driver software

This unit works with the operating system's standard driver.

About trademarks and registered trademarks

- Pioneer DJ is a trademark of PIONEER CORPORATION and is used under license.
- rekordbox™ and WeDJ are trademarks or registered trademarks of Pioneer DJ Corporation.
- iPhone, iPod touch, Mac, macOS, Lightning and Finder are trademarks of Apple Inc., registered in the U.S. and other countries.
- App Store is a service mark of Apple Inc.
- iOS is a trademark or registered trademark of Cisco Systems, Inc. in the U.S and other countries, and is used under license.
- Windows is a registered trademark of Microsoft Corporation in the United States and other countries.
- Intel and Intel Core are trademarks of Intel Corporation in the U.S. and other countries.
- The *Bluetooth*® word mark and logos are registered trademarks owned by Bluetooth SIG, Inc. and any use of such marks by Pioneer DJ Corporation is under license. Other trademarks and trade names are those of their respective owners.
- Beatport and the Beatport logo are trademarks or registered trademarks of the Beatport, LLC.
- SoundCloud and the SoundCloud logo are registered trademarks of SoundCloud Ltd.
- djay and the djay logo are trademarks or registered trademarks of Algoriddim GmbH.
- edjing Mix and edjing Mix logo are trademarks or registered trademarks of MWM SAS.

The names of companies and products mentioned herein are trademarks or registered trademarks of their respective owners.

This product has been licensed for nonprofit use. This product has not been licensed for commercial purposes (for profit-making use), such as broadcasting (terrestrial, satellite, cable or other types of

Additional information

broadcasting), streaming on the Internet, Intranet (a corporate network) or other types of networks or distributing of electronic information (online digital music distribution service). You need to acquire the corresponding licenses for such uses. For details, refer to <http://www.mp3licensing.com>.

Cautions on copyrights

rekordbox and WeDJ restrict playback and duplication of copyright-protected music contents.

- When coded data, etc., for protecting the copyright is embedded in the music contents, it may not be possible to operate the program normally.
- When rekordbox and WeDJ detect that coded data, etc., for protecting the copyright is embedded in the music contents, processing (playback, reading, etc.) may stop.

Recordings you have made are for your personal enjoyment and according to copyright laws may not be used without the consent of the copyright holder.

- Music recorded from CDs, etc., is protected by the copyright laws of individual countries and by international treaties. It is the full responsibility of the person who has recorded the music to ensure that it is used legally.
- When handling music downloaded from the Internet, etc., it is the full responsibility of the person who has downloaded the music to ensure that it is used in accordance with the contract concluded with the download site.

The specifications and design of this product are subject to change without notice.

© 2019 Pioneer DJ Corporation.

All rights reserved.

<DRI1596-A>