

OWNER'S MANUAL BEDIENUNGSANLEITUNG

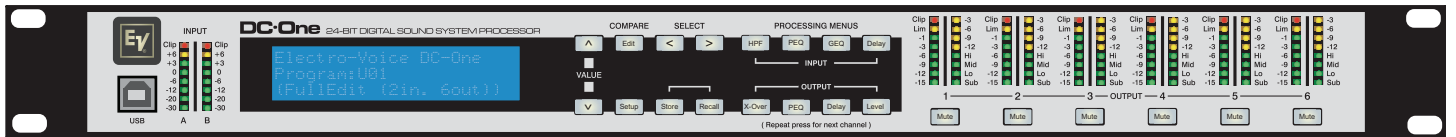

DC-One

24-BIT DIGITAL SOUND SYSTEM PROCESSOR

CONTENTS

Overview	6
Introduction	8
DC-One Features	8
Controls & Connection	10
Front Panel	10
Rear Panel	14
Installation	16
Editing & Operation	19
Factory Presets	19
User Presets – Standard Editing	19
User Preset – Full Editing	19
Unpacking & Warranty	19
Run-time Mode	20
LCD Display	20
Input Level Meters	20
Output Level Meters	20
Output Gain Reduction Meters	21
Output Channel Mute Buttons	21
Output Channel Function Indicators	21
Preset Recall	21
Preset Store	22
Edit	22
Parameters	23
Setup	32
Setup Menus	32
Configurations of the DC-One	36
2-Way Stereo + Full Range	37
3-Way Stereo	38
4-Way + FR	39
5-Way + FR	40
Free Configuration - Full Edit 2 In 6 Out	41
3-Way Stereo-MonoSub+FR	42
4-Way Stereo-MonoSub/LF	43
Operation Modes & Presets	44
Specifications	46
Dimensions	47

INHALT

Übersicht	52
Einleitung	54
DC-One Ausstattungsmerkmale	54
Bedienelemente & Anschlüsse	56
Gerätevorderseite	56
Geräterückseite	61
Installation	63
Editieren & Betrieb	66
Werks-Presets	66
Anwender-Presets – Standardeditierung	66
Anwender-Preset – Kompletteditierung	66
Auspacken & Garantie	66
Run-Time-Modus	67
LCD (Display)	67
Pegelanzeigen der Eingangssignale	67
Pegelanzeigen der Ausgangssignale	67
Gain Reduction-Anzeigen der Ausgangskanäle	68
Mute-Tasten der Ausgangskanäle	68
Funktionsanzeigen der Ausgangskanäle	68
Presets aufrufen	68
Preset speichern	69
Editieren	70
Parameter	71
Setup	80
Setup-Menüs	80
DC-One Konfigurationen	84
Stereo 2-Wege + Full Range	85
3-Wege Stereo	86
4-Way + FR	87
5-Way + FR	88
Freie Konfiguration - Full Edit 2 In 6 Out	89
3-Wege Stereo-MonoSub+FR	90
4-Wege Stereo-MonoSub/LF	91
Operation Modes & Presets	92
Technische Daten	94
Abmessungen	95
EQ Plot Images	96
6 dB PEQ Cuts Q Changes	96
6 dB-Oct Shelves at 200 Hz and 2 kHz	96
12 dB PEQ Cuts Q Changes	97
12dB-Oct Shelves at 200 Hz and 2 kHz	97
Bessel Filters	98
Butterworth Filters	98
Hi Lo Pass Filters	99
Linkwitz-Riley Filters	99
PEQ Gains	100

IMPORTANT SAFETY INSTRUCTIONS

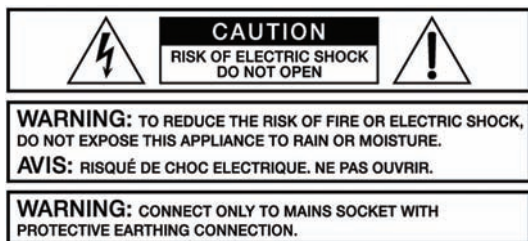

The lightning flash with arrowhead symbol, within an equilateral triangle is intended to alert the user to the presence of uninsulated "dangerous voltage" within the product's enclosure that may be of sufficient magnitude to constitute a risk of electric shock to persons.



The exclamation point within an equilateral triangle is intended to alert the user to the presence of important operating and maintenance (servicing) instructions in the literature accompanying the product.

1. Read these instructions.
2. Keep these instructions.
3. Heed all warnings.
4. Follow all instructions.
5. Do not use this apparatus near water.
6. Clean only with a dry cloth.
7. Do not block any ventilation openings. Install in accordance with the manufacturer's instructions.
8. Do not install near heat sources such as radiators, heat registers, stoves, or other apparatus (including amplifiers) that produce heat.
9. Do not defeat the safety purpose of the polarized or the grounding-type plug. A polarized plug has two blades with one wider than the other. A grounding type plug has two blades and a third grounding prong. The wide blade or the third prong are provided for your safety. If the provided plug does not fit into your outlet, consult an electrician for replacement of the obsolete outlet.
10. Protect the power cord from being walked on or pinched particularly at plugs, convenience receptacles, and the point where they exit from the apparatus.
11. Only use attachments/accessories specified by the manufacturer.
12. Use only with the cart, stand, tripod, bracket, or table specified by the manufacturer, or sold with the apparatus. When a cart is used, use caution when moving the cart/apparatus combination to avoid injury from tip-over.



13. Unplug this apparatus during lightning storms or when unused for a long period of time.
14. Refer all servicing to qualified service personnel. Servicing is required when the apparatus has been damaged in any way, such as power-supply cord or plug is damaged, liquid has been spilled or objects have fallen into the apparatus, the apparatus has been exposed to rain or moisture, does not operate normally, or has been dropped.
15. Do not expose this equipment to dripping or splashing and ensure that no objects filled with liquids, such as vases, are placed on the equipment.
16. To completely disconnect this equipment from the AC Mains, disconnect the power supply cord plug from the AC receptacle.
17. The mains plug of the power supply cord shall remain readily operable.
18. No naked flame sources, such as lighted candles, should be placed on the apparatus.
19. This is an CLASS I apparatus and shall be connected to a main socket outlet with a protective earth connection.



**FOR RECYCLING
INFORMATION
CONTACT YOUR
DISTRIBUTOR OR
VISIT OUR WEBSITE**

WWW.EVIAUDIO.COM

WEEE Recycling/Disposal Instructions

The Wheelie Bin symbol found on the product or in the manual indicates that this product must not be disposed of with other waste. It is in our category the manufacturer's responsibility to properly dispose of their waste electrical and electronic equipment (WEEE) at the end of its life. Due to the differences in each EU country's management of WEEE, please contact your local distributor. We are committed to facilitate our own electronic-waste-management-system, for the free of charge return of all EVI Audio GmbH products: Telex, Dynacord, ElectroVoice, Midas Consoles, KlarkTeknik and RTS. Arrangements are made with the dealer where you purchased the equipment from, for the returning of all unusable equipment **at no cost**, to the factory in Straubing, for environmental protective disposal.

IMPORTANT SERVICE INSTRUCTIONS

CAUTION: These servicing instructions are for use by qualified personnel only. To reduce the risk of electric shock, do not perform any servicing other than that contained in the Operating Instructions unless you are qualified to do so. Refer all servicing to qualified service personnel.

1. Security regulations as stated in the EN 60065 (VDE 0860 / IEC 65) and the CSA E65 - 94 have to be obeyed when servicing the appliance.
2. Use of a mains separator transformer is mandatory during maintenance while the appliance is opened, needs to be operated and is connected to the mains.
3. Switch off the power before retrofitting any extensions, changing the mains voltage or the output voltage.
4. The minimum distance between parts carrying mains voltage and any accessible metal piece (metal enclosure), respectively between the mains poles has to be 3 mm and needs to be minded at all times. The minimum distance between parts carrying mains voltage and any switches or breakers that are not connected to the mains (secondary parts) has to be 6 mm and needs to be minded at all times.
5. Replacing special components that are marked in the circuit diagram using the security symbol (Note) is only permissible when using original parts.
6. Altering the circuitry without prior consent or advice is not legitimate.
7. Any work security regulations that are applicable at the locations where the appliance is being serviced have to be strictly obeyed. This applies also to any regulations about the work place itself.
8. All instructions concerning the handling of MOS-circuits have to be observed.

NOTE:



SAFETY COMPONENT (MUST BE REPLACED BY ORIGINAL PART)

1 Overview

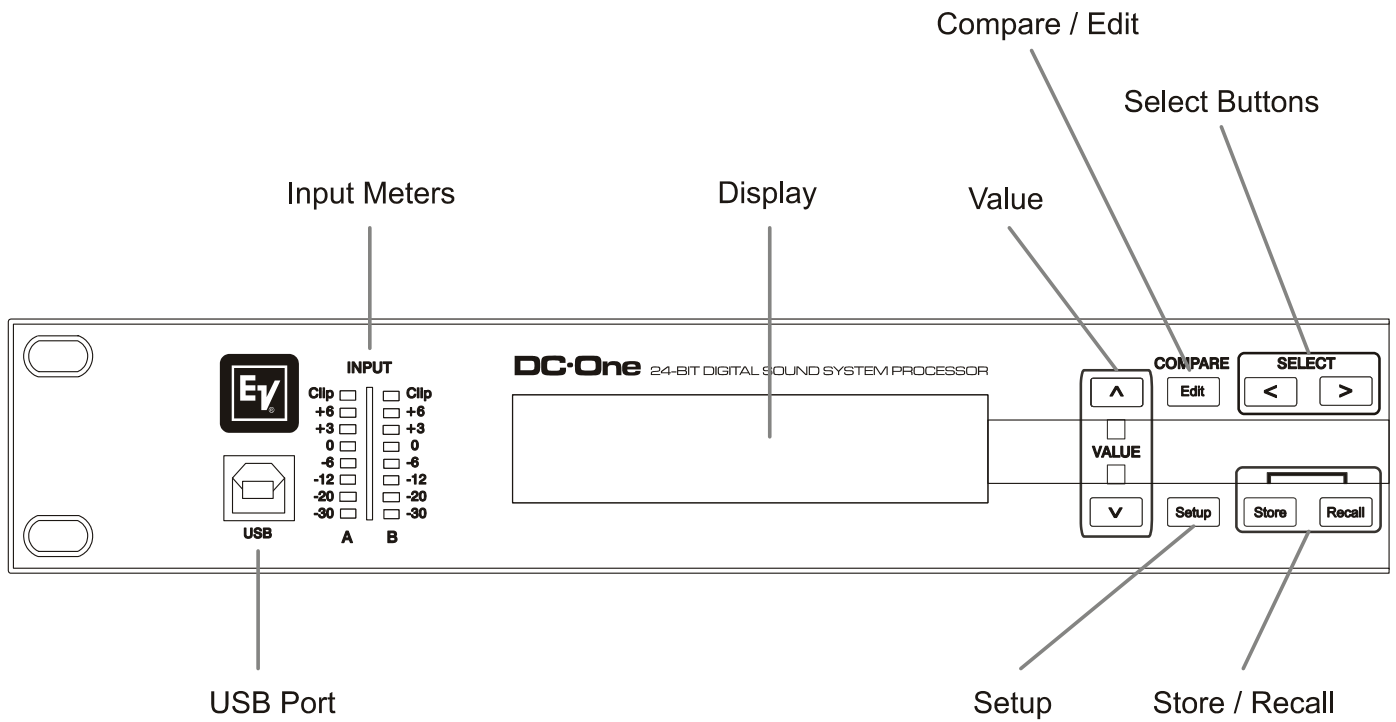

Processing Menus for High Pass Filter, Parametric EQ, Graphic EQ and Delay

Output Gain Reduction Meters, Output Channel Function Indicators and Output Level Meters

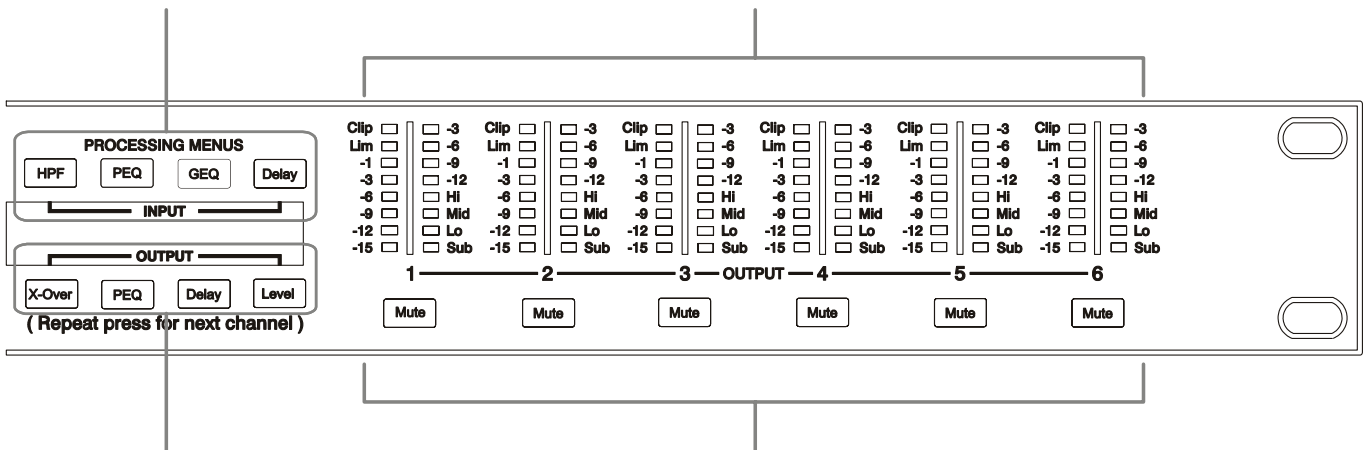

Output Control buttons for Cross-Over, Parametric EQ, Delay and Level

Output Channel Mute Buttons

2 Introduction

Thank you for purchasing the Electro-Voice DC-One Digital Signal Processor. The Electro-Voice DC-One Digital System Processor is a universal two-input, six-output digital signal processor with the flexibility of configuration to handle a multitude of audio system needs and applications; installed sound, house of worship, convention & meeting facilities, concert touring, club, portable sound reinforcement and more.

IMPORTANT NOTE:



To achieve optimum performance and guard against damage to the processor, your sound system or yourself, please read, understand and follow all of the directions contained in this Owner's Manual. Failure to do so may result in improper performance, loss or injury.

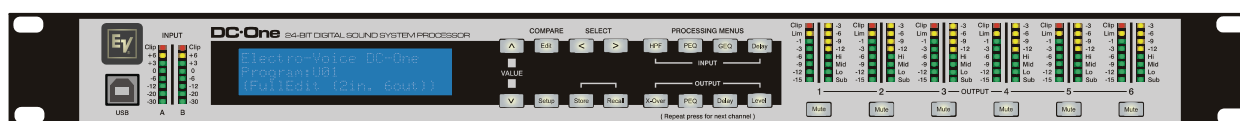

2.1 DC-One Features

The internal routing matrix can be configured as 2-way stereo + full-range, 3-way stereo, 4-way mono + full-range, 5-way mono + full range, 3-way stereo with a mono sub + full-range, 4-way stereo with mono sub and low frequency and finally as a freely assignable 2 x 6 matrix router.

The DC-One replaces entire racks of signal processors previously needed to properly configure and control sound reinforcement systems with a single Analog Devices® SHARC™ DSP processor. The substantial advantages of the DC-One over discrete signal processing racks include:

- 24-bit, 48 kHz digital signal path
- No patch cables to fail or add noise
- Optimal gain structure throughout all stages of signal processing; no gain matching from processor to processor.
- Recallable factory and user presets; instant system reconfiguration for differing applications and performances.
- Easy, intuitive operation and editing with a PC and the DC-One Graphic User Interface Application.

Each DC-One Digital System Processor includes the following signal processing blocks:

- Input VU Metering
- Analog or AES/EBU inputs
- 24-bit, 48 kHz A/D converters
- Stereo Hi-pass filters
- Stereo 9-band parametric equalizer
- Stereo 31-band graphic equalizer
- Stereo delay

Matrix Router / Mixer

- Two inputs (stereo)
- Summed left / right (mono) input
- Six assignable outputs

Outputs (each)

- Cross-over (hi-pass / low-pass filters), with selectable filter types
- 5-band parametric equalizer
- Delay
- Polarity
- Peak RMS detecting limiter
- Level & Mute
- 24-bit, 48 kHz D/A converters

Additional features include:

- Electronically balanced XLR inputs and outputs
- -6 dB switchable input level pad
- Contact closure interface for recall of up to eight selectable presets
- Front-panel USB port for connection to PC; preset editing and real time parameter control and monitoring.
- Firmware updates
- FLASH memory for preset storage and in-field firmware upgrades
- Input level meters
- 192 x 32 back-lit graphic LCD display
- LCD navigation / editing controls
- DSP block navigation short-cut controls
- Output level meters
- Output gain reduction meters
- Output assignment display LEDs; sub, low, mid & high
- Output channel Mute controls
- Auto-ranging internal power supply; 100-240 V AC, 50-60 Hz
- Standard IEC A.C. inlet with external, replaceable fuse

3 Controls & Connection

3.1 Front Panel

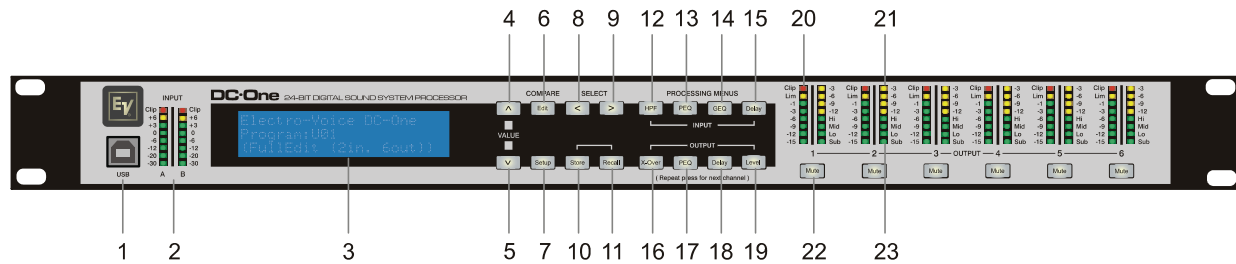

1 – USB Connector

USB 1.1 port for connection to a PC running Windows XP or Vista. With a connected PC you may run the DC-One Editor Graphic User Interface Application. The DC-One can be operated, edited and configured for installation with an easy to use, intuitive interface. Any available firmware updates downloadable from www.electrovoice.com can be loaded via the USB port as well; allowing for easy in-field updates.

2 – Input Level Meters

The DC-One does not itself have input level controls. Proper input level adjustment is accomplished by setting the output level from the (L / R) bus outputs from the connected mixer (or other audio output device), as the vast majority of today's mixer-outputs are dBu calibrated. When the mixer is operating at optimal levels, so is the DC-One. The input meters monitor the input level of either analog or AES-EBU inputs, depending on the input mode selection set in the Setup Menu.

Optimal signal-to-noise performance is obtained when the nominal (average), input level consistently lights the +3dBu (green) and / or +6dBu (Yellow) LED indicators. As the DC-One is a digital audio device – and digital clipping produces very unpleasant results, the Clip (red) LED should not light. If the DC-One's input does clip, reduce the output level of the connected mixer. The -6dB PAD button at the rear panel can be used for adjusting the input level also.

3 – LCD Display

The back-lit, 192 x 32 graphic LCD display allows for operation and editing of the DC-One without the need for an attached PC. The contrast can be set in the Setup Menu for varying lighting conditions and viewing angles.

The LCD display works in conjunction with Menu buttons, Select buttons and Value buttons - to operate, navigate and edit the DC-One's parameters.

In Run mode, the LCD displays the number and name of the currently selected factory or user preset. Pressing the Recall or Store buttons switches to their respective menus. Pressing the Edit or Setup menu buttons switches the display to the last edited parameter.

In Edit and Setup mode, the top line of the LCD display shows the currently selected parameter edit

screen. Use the Select buttons to activate the top line of the display, and the value buttons to scroll through available parameter edit screens.

4/5 – Value Up/Down Buttons

Depending on the current LCD screen, the Value Up/Down Buttons performs the following function:

- Recall – Select forwards/backwards through the stored preset list to select a preset to be recalled to current memory.
- Store – Select User Preset destinations forwards/backwards to select a destination for the currently edited preset, scroll forwards through ANSI character set to name preset.
- Edit / Setup – Scroll forwards/backwards through Edit / Setup screens when the top line of the LCD screen is active. Scroll forwards through values for the selected parameter in an Edit / Setup screen.

6 – Edit / Compare Button

Pressing the Edit button while in Run mode places the current preset in Edit mode and the Edit button lights. The LCD display shows the last edit screen that was selected. From this point, any edit screen can be displayed and altered.

Pressing the Edit button again “compares” the edited preset, if parameters have been altered, to the original un-edited preset. This compare function will audibly switch between the altered parameters and the previously stored settings, allowing you to hear the effect of any DSP changes that have been made. Use this feature to monitor progress in editing or creating presets.

Subsequently recalling a new preset will prompt you to save changes, which you may do or not.

7 – Setup Button

Pressing the Setup button while in Run mode displays the Setup menus in the LCD display and the Setup button lights. In this mode, any Setup menu can be displayed and altered. Changes made to Setup menu items are saved automatically.

To exit Setup mode, press the Setup button again. The LCD display will revert to Run mode.

8 – Select < Button

The Select < button is pressed to navigate backwards through Edit, Setup and / or Recall menu displayed. The button cycles through all available value fields in a screen and wraps around from first to last.

9 – Select > Button

The Select > button is pressed to navigate forwards through Edit, Setup and / or Recall menu displayed. The button cycles through all available value fields in a screen and wraps around from last to first.

10 – Store Button

Pressing the Store button while in Run mode displays the Store Preset screen in the LCD display and the Store button lights. In this screen edited presets can be named and saved to a user preset location. Pressing the Store button again completes the preset save operation.

To exit without storing the current preset, press the Edit or Setup buttons to return to the Run mode screen.

11 – Recall Button

Pressing the Recall button while in Run mode displays the Recall Preset screen in the LCD display and the Recall button lights. In this screen, any of the 60 factory and 20 user presets can be recalled into current memory. Pressing the Recall button again completes the preset load operation and returns the LCD display to Run mode.

To exit without storing the current preset, press the Edit or Setup buttons to return to the Run mode screen.

12 – Input HPF Button

Pressing the HPF button places the current preset in Edit mode and jumps to the Hi-Pass Filter screen of Input A. Subsequent button presses toggle the display between Input A and Input B.

13 – Input PEQ Button

Pressing the PEQ button places the current preset in Edit mode and jumps to the first screen of the Input Parametric Equalizer. Subsequent button presses toggle the display between Input A and Input B.

14 – Input GEQ Button

Pressing the GEQ button places the current preset in Edit mode and jumps to the the Input Graphic Equalizer screen. Subsequent button presses toggle the display between Input A and Input B.

15 – Input Delay Button

Pressing the Delay button places the current preset in Edit mode and jumps to the Input Delay screen. Subsequent button presses toggle the display between Input A and Input B.

16 – Output X-Over Button

Pressing the X-Over button places the current preset in Edit mode and jumps to the first Output Channel Cross-Over screen. Subsequent button presses step through the available output channels (depending on configuration).

17 – Output PEQ Button

Pressing the PEQ button places the current preset in Edit mode and jumps to the first Output Parametric Equalizer screen. Subsequent button presses step through the available output channels (depending on configuration).

18 – Output Delay Button

Pressing the Delay button places the current preset in Edit mode and jumps to the Output Channel Delay screen. Subsequent button presses step through the available output channels (depending on configuration).

19 – Output Level Button

Pressing the Level button places the current preset in Edit mode and jumps to the Output Channel Level screen. Subsequent button presses step through the available output channels (depending on configuration).

20 – Output Level Meters

Each output channel has an eight-segment output level VU meter. Meter response characteristics can be selected in the Setup menu: Normal Fast, Peak-Hold Slow Decay. The yellow segment indicates that limiting is being applied to the output channel. The red segments indicates clipping of the D/A converters and should be avoided by adjusting the Output Level of the output channel. It is important to understand how the meters work and what they are displaying. The Output Meters are displayed as “dB to Limiter Threshold”. In other words, these meters will display the headroom between the output level and the limiter threshold. When viewed in conjunction with the Gain Reduction meters, this provides a complete display of level and headroom before and after limiting has been engaged to allow system levels to be optimized. This also means that the output metering will be displayed differently depending on the limiter threshold setting.

21 – Output Gain Reduction Meters

Each output channel has a four-segment gain reduction meter that shows the effect of the output channel Limiter on output level; from 0dB to -12dB.

22 – Output Channel Mute Buttons

Each output channel has a lighted Mute button. Pressing the Mute button turns off the output of that channel. The button lights red as an alert. Press the Mute button again to restore the output channel's signal.

Output channels may also be muted from the DC-One Graphic User Interface Application, if the unit is connected to a PC. Muting a channel in any window of the application will light the channel Mute button on the front panel of the unit as well.

23 – Output Channel Function Indicators

Each output channel has a four-segment function display for informational purposes only. For any given configuration possible with the DC-One, an output channel may be identified as a sub, low, low/mid, mid, mid/hi, hi or full range output. One or two adjacent LED are displayed to indicate all possible output bandpasses. (Full range is indicated by no lit LED's.)

3.2 Rear Panel

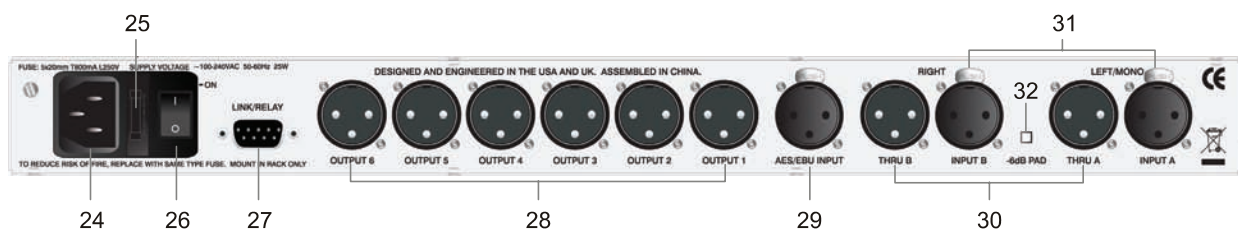

24- A.C. Inlet

The DC-One features a standard IEC A.C. inlet that will accept universal power cords. The DC-One power supply is auto-ranging and can accept voltages from 100 - 240 V AC, 50 – 60 Hz. Only A.C. cords approved for use in your country should be connected to the DC-One.

25 – A.C. Fuse

The A.C. inlet includes a fuse holder that contains the mains fuse as well as a spare fuse. If necessary, replace the fuse only with a specified 5x20mm, T800 mA, L250 V replacement. Disconnect A.C. power before replacing a fuse. Before turning the unit back on, assess the condition of the A.C. receptacle powering the DC-One. If fuses continue to blow, refer servicing of the DC-One only to qualified service personnel.

26 – A.C. Power Switch

The A.C. power switch turns power to the DC-One On and Off.

27 – Link/Relay Interface

The operating mode of this dual purpose interface is selected in the Setup menu. Operating modes are:

- **RS-232 Interface** - Used to link two DC-Ones together in a Master/Slave setup. Connection is made via a standard 9-pin null-modem serial interface cable with female connectors.
- **Contact Closure Port** - Eight contact closure pins plus ground for interfacing to 5 V contact closure systems. Each pin can be assigned a preset that is recalled when voltage on that pin is detected. The lowest pin number takes priority in multiple controller systems.

28 – Balanced XLR Outputs

Each output channel has an electronically balanced XLR connector for connection to system amplifiers. Each output channel can output different frequency ranges depending on its assignment and cross-over settings.



Care must be taken to assure that each output is connected to an appropriate amplifier and loudspeaker to avoid damage or unexpected results. Note that a new preset may change the assignment of channel and its frequency range. For instance an output assigned to Hi frequency speakers in one preset, may be assigned as a sub output in another. See “Configurations of the DC-One”.

29 – AES/EBU Digital Input

In addition to the analog audio inputs, an AES/EBU digital stereo input is provided and selectable in the Setup menu. The input conforms to IEC standard 60958 Type I. Connections must be made with three-conductor, 110-Ohm, twisted pair cabling and an XLR connector.

30 – Balanced XLR Thru

Each analog audio input is connected to an electronically buffered and balanced output as a through connector. The signal does not undergo any digital conversion or processing. These connectors are used to pass input audio to a second DC-One used as a slave or to other audio inputs in the system.

31 – Balanced XLR Inputs

Each input has an electronically balanced, locking XLR connector. In stereo or dual modes, connections to both inputs must be made. In mono modes, only one connection need be made, typically to Input A.

32 – 6dB Pad

Input levels to the DC-One can be reduced 6dB prior to the A/D converter to compensate for higher-level output from mixers and other audio devices. For ideal signal to noise performance when connecting the DC-One to high output level devices engage the 6dB pad rather than turning down the output of the connected device. The DC-One's Input level Meters (2) will indicate incoming signal level and whether attenuation is required.

3.3 Installation

For proper operation, all directions regarding installation and connection must be followed.

Mounting

The DC-One should be mounted in a rack-mount enclosure or rack rails. The unit is 1RU tall by 14" (353mm) deep. Proper clearance for air circulation around the unit must be provided. Do not block any vent holes on the unit. All four mounting points provided by the rack ears must be secured.

Power Connection

The DC-One must be connected to A.C. power only by means of the provided IEC A.C. cable or by a power cable provided by the dealer / installer to match the configuration of your country or region. The DC-One must only be connected to a properly wired, three pin, grounded A.C. outlet. A.C. power must range from 100 – 240VAC, 50 – 60Hz. The DC-One internal power supply is an auto-ranging design; no adjustments are necessary to configure it for proper A.C. power.

Audio Cables

Always use correctly shielded audio cables when connecting to the DC-One.

Balanced Input / Output Connections

To minimize induced noise caused by audio cables and to maximize the length of cables used, balanced connections are strongly advised for both Inputs and Outputs. The XLR jacks provided on the DC-One are configured as pin 1 ground, pin 2 hot (+), pin 3 cold (-). Cable shielding must be connected to pin 1. XLR – XLR cables or ¼" tip-ring-sleeve – XLR cables can both be used for balanced connections to the DC-One.

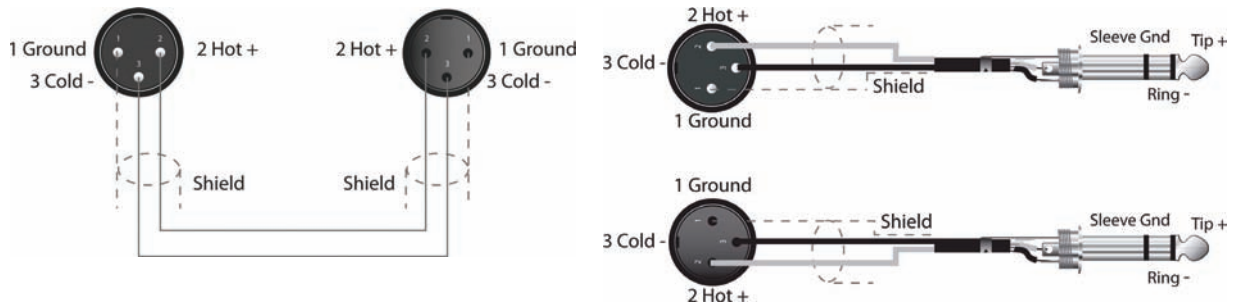

Un-balanced Input / Output Connections

Un-balanced connections can be made to the DC-One, although induced noise from cabling may be increased. Cables should also be less than 15” (5m) in length. Unbalanced connections can be 6dB lower in level as well. To match the audio level obtained with a balanced connection, it is necessary to tie pin 3 to ground at the XLR connector. This may increase noise.

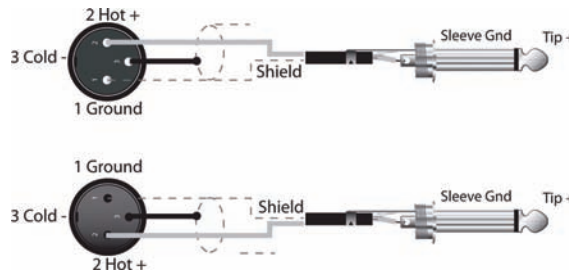

RS-232

Two DC-Ones can be used in combination as a Master / Slave for managing larger sound reinforcement systems. A 9-pin D-Sub connector is provided on the rear of each unit for data line connections. A standard female-to-female RS-232 cable that conforms to the null modem wiring convention is used to connect the two units. Cable length should be kept to less than 45 feet (15 m) for the most reliable operation. These cables are readily available at local computer dealers. Operation of the DC-One 9-pin port for RS-232 connections is selected in the Setup menu.



Relay Contact Closure

The same 9-pin port used for RS-232 connection to another DC-One can alternately be used to recall presets from relay contact closures. Pins 1 – 4 and pins 5 – 9 are the input lines and pin 5 provides the ground reference. When the DC-One detects a connection between pin-5 ground and input pins, as completed by an external relay, a preset assigned by the user to input pins is recalled into memory and the DC-One returns to run-time mode.

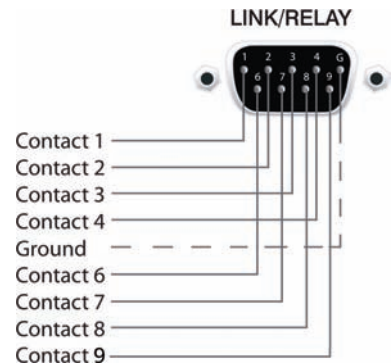

USB

Connecting the DC-One to a PC for operation via the DC-One Graphic User Interface application is accomplished via the front panel USB port. The port conforms to the USB 1.1 Type B specification. Type B USB cables are readily available at computer dealers.

Connection to Amplifiers

It is very important to confirm correct connection to all amplifiers. DC-One has the ability to configure each output for a specific frequency range; sub, low freq. mid freq, high freq. You must make sure that each output is connected to the correct amplifier and loudspeaker(s). Incorrect connections could lead to unexpected results or damage to loudspeaker components.



Note also that each preset in the DC-One includes DSP and bandpass parameters for the output channels. It is possible for a new preset to change an output from Hi to Sub, for instance. Make sure that connections to amplifiers and loudspeakers are correct before using a new preset.

Input Level Adjustment

The final step in setting up, installing and connecting the DC-One is to set proper input levels to the unit. The DC-One does not itself have input level controls. Proper input level setting is accomplished by setting the output level from the (L / R) bus outputs from the connected mixer (or other audio output device). The input meters monitor the input level of either analog or AES/EBU inputs, depending on the input mode selection set in the Setup Menu.

Optimal signal-to-noise performance is obtained when the nominal (average), input level consistently lights the +3dBu (green) and / or +6dBu (Yellow) LED indicators. As the DC-One is a digital audio device – and digital clipping produces very unpleasant results – the Clip (red) LED should never light. If it does, reduce the output level of the connected mixer.

INPUT	
Clip	Clip
+6	+6
+3	+3
0	0
-6	-6
-12	-12
-20	-20
-30	-30
A	B

Input levels to the DC-One can be reduced 6dB with the rear panel pad switch to compensate for higher-level output from mixers and other audio devices. For ideal signal to noise performance when connecting the DC-One to high output level devices, engage the 6dB pad rather than turning down the output of the connected device.

4 Editing & Operation

4.1 Factory Presets

The DC-One comes with 60 factory presets to configure and manage typical sound reinforcement systems. Factory presets can be recalled at will. Limited editing can be performed from the front-panel LCD user interface such as output level, mute and limiter threshold setting. Installers can identify factory presets with system configurations that are not appropriate for the given installation and lock-out and hide them from the operator.

4.2 User Presets – Standard Editing

The DC-One uniquely allows for limited access to and visibility of parameters. Via the DC-One Graphic User Interface Application, the installer can determine which parameters may be accessed.



4.3 User Preset – Full Editing

The DC-One can also be configured in full-edit mode. All matrix routing presets are available including 2 x 6 Full Edit. All DSP parameters are accessible and adjustable. Resulting settings can be saved into 20 User Preset locations for later recall. Editing can be performed from the front-panel LCD display or on a PC with the DC-One Editor Graphic User Interface Application. Full editing is recommended only for experienced installers / operators.



4.4 Unpacking & Warranty

Carefully remove the DC-One from its packaging and packaging materials. Please save all packing materials and box, should you ever need to return the DC-One for warranty service.

Included with the DC-One is this Owner's Manual, Warranty card and A.C. power cable. Contact your distributor, dealer or installer if any of these items is not included.

Fill out the warranty card in its entirety and return it to the address noted. Only products for which completed warranty cards have been received will be covered fully under warranty.¹ The factory warranty for your DC-One is **36 months** (3 years), from the date of purchase. Please save the warranty certificate and receipt; which must be presented at the time of warranty service for the factory warrantee to be valid.

¹) Warranty coverage rights vary by state and country. Your warranty rights may vary. Consult your distributor, dealer or installer for your warranty rights.

5 Run-time Mode

5.1 LCD Display

On power-up, the DC-One boots and displays the run-time screen. The current preset memory location and name are displayed as well as the configuration on which the preset is based.



CAUTION

Before operating the sound reinforcement system, and any time a new preset is recalled, check the configuration display to make sure that it is appropriate for your system and that connections to your system are correct for the current configuration. Failure to do so could cause unexpected results or damage to the system or its components.

The LCD display's contrast can be adjusted in the Setup Menu to accommodate different viewing angles.



5.2 Input Level Meters

During operation, the left and right input level meters display the signal present at the DC-One's analog and Digital inputs. The DC-One does not itself have input level controls. Proper input level setting is accomplished by setting the output level from the (L / R) bus outputs from the connected mixer or other audio source.

Optimal signal-to-noise performance is obtained when the nominal (average), input level consistently lights the +3dBu (green) and / or +6dBu (yellow) LED indicators. As the DC-One is a digital audio device – and digital clipping produces very unpleasant results – the Clip (red) LED should never light. If it does, reduce the output level of the connected mixer. The -6dB PAD button at the rear panel can be used for adjusting the input level also.

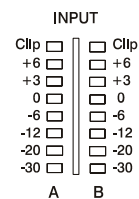

5.3 Output Level Meters

Each output channel has an eight-segment output level VU meter. Meter response characteristics can be selected in the Setup menu: Normal Fast, Peak-Hold or Slow Decay. The yellow segment indicates that limiting is being applied to the output channel. It is important to understand how the meters work and what they are displaying. The Output Meters are displayed as “dB to Limiter Threshold”. In other words, these meters will display the headroom between the output level and the limiter threshold. When viewed in conjunction with the Gain Reduction meters, this provides a complete display of level and headroom before and after limiting has been engaged to allow system levels to be optimized. This also means that the output metering will be displayed differently depending on the limiter threshold setting. The red segments indicates clipping of the D/A converters and should be avoided by adjusting the Output Level setting of the output channel.

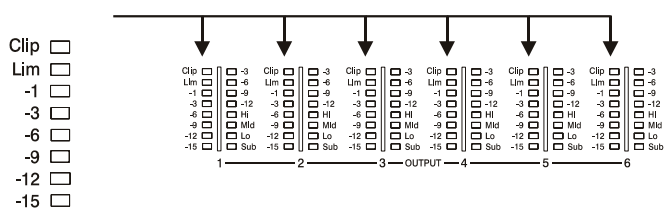

5.4 Output Gain Reduction Meters

Each output channel has a four-segment gain reduction meter that shows the effect of the output channel Limiter on output level; from 0dB to -12dB. Output limiting can be bypassed by entering Edit mode, selecting Output Channel Limiter and selecting a limiter threshold of +21 dBu (8.691V) or turning the Bypass parameter to “On”.

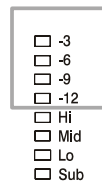

5.5 Output Channel Mute Buttons

Each output channel has a lighted Mute button. Pressing the Mute button turns off the output of that channel. The button lights red as an alert. Press the Mute button again to restore the output channel's signal.

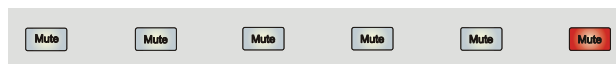

5.6 Output Channel Function Indicators

Each output channel has a four-segment function display for informational purposes only. For any given configuration possible with the DC-One, an output channel may be identified as a sub, low, low/mid, mid, mid/hi, hi or full range output. One or two adjacent LED's are displayed to indicate all possible output bandpasses. (Full range is indicated by no lit LED's.)

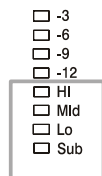

5.7 Preset Recall

The DC-One preset memory provides 60 factory program presets and can store up to 20 user presets. (F01-F60, U01-U20) Factory presets have been designed to represent common system configurations utilizing Electro-Voice loudspeaker systems. User presets allow you to accommodate other system configurations and / or loudspeaker systems.

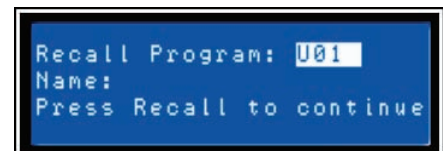

To recall a preset, press the front panel Recall button. The display switches to the Recall Preset screen and displays the next in a list of available presets in memory. Using the Value Up and Down buttons, select the preset to be recalled. Valid presets will display the preset name. Empty presets will display a “?”.

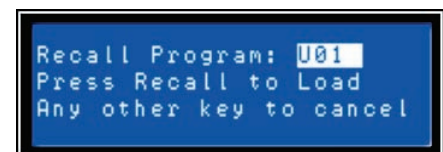

Select a valid preset and press Recall again. The display will prompt, “Recall Preset? Press Recall”. Press Recall a third time to confirm and load the new preset.

If the preset you are recalling is based on a configuration different from that of the current preset, the display will prompt, “**Changing config can damage speakers**”, to remind you that the new preset may not be appropriate for your system as it is currently connected. Press Recall again to confirm and load the new preset.



Make sure that the new preset is appropriate for your system, and that connections to your system are correct for the current configuration. Failure to do so could cause unexpected results or damage to the system or its components.

To exit the Recall process without loading a new preset, press the Edit, Setup or any of the DSP block buttons. (Edit or Setup buttons will return the display to run-time mode. DSP block buttons will display the corresponding DSP block edit screen.)

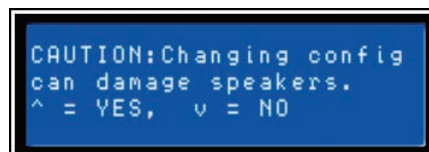

5.8 Preset Store

Edited presets can be stored in one of 20 User Preset locations. (U01 – U20) To store a preset, press the Store button. The LCD display will switch to the Store Program screen. Use the Value Up and Down buttons to select the user destination. Locations that already have presets saved in them will display a preset name. Empty locations will display “?” in the name field. You may select an empty location, or a location of a preset that will be over-written.

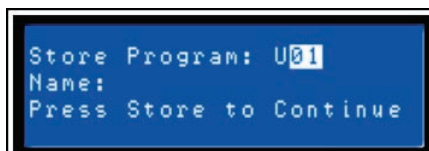

Press the < Select > buttons to navigate down to the preset name field. Use the Value Up and Down buttons to select the field for each letter / symbol character. The DC-One provides the complete ANSI character set, including lower-case & upper-case letters, numerals and symbols. Pressing and holding the Value Up and Down buttons will scroll rapidly through the character set. Press the < Select > buttons to move to the next or previous character position.

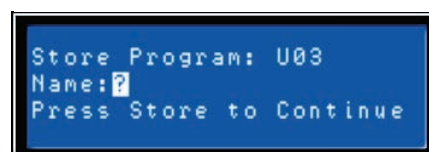

When the preset is named, press Store again. If the preset location was previously empty, the display will prompt “Are you sure? Press Store”. If you are overwriting an existing preset the display will prompt “Overwrite Preset? Press Store”. In either case, press Store again to proceed and store the new preset.

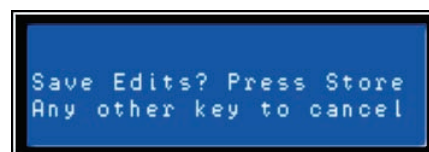
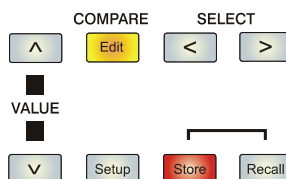

To Exit Store without saving the edited preset, press the Edit, Setup or any of the DSP block buttons. (Edit or Setup buttons will return the display to run-time mode. DSP block buttons will display the corresponding DSP block edit screen.)

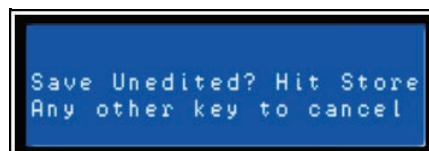

5.9 Edit

Both Factory and User preset can be edited, but edited presets can only be stored in User preset locations.

Standard Edit Mode

The DC-One defaults to Standard Edit mode wherein, input and output channel parameters are appropriately linked. (Refer to “Configurations” illustrations to see which channels are parameter-linked for each configuration.)

Linked parameters are always identical in value. For instance, setting a graphic eq curve for Input A, sets

the same curve for Input B, if the configuration has linked stereo inputs. Either input channel can be edited; changes will be reflected in both. The same is true for parameters of linked output channels. The only exception to the linking of parameters is the Mute buttons. Output channels can be individually muted at any time, either from the DC-One front panel or the Graphic User Interface application.

Full Edit Mode

In the Setup menu, the edit mode can be changed to Full Edit. In Full Edit, no parameter links are enforced, regardless of the configuration selected. Any parameter can be changed without any effect on other parameter values.



Regardless of the edit mode selected, there are two means to enter edit mode: pressing the Edit button or pressing any DSP block button.

Use the < Select > buttons to navigate to the top line of any edit screen, and the Value Up and Down buttons to navigate to any other Edit screen. As a short-cut, press a DSP block button to jump to the last selected screen of said block and navigate as above to reach the desired screen.

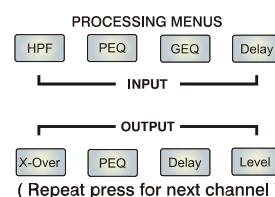

5.10 Parameters

The following section is a detailed description of every DSP parameter available in the DC-One; grouped by DSP block, in order of the signal flow of the DC-One.

Input A&B DSP Block



Output 1-6 DSP Block



Not all parameters may be accessible in every preset and, depending on the configurations set by the contractor/installer, not all presets and/or preset values may be available for editing. Changes to preset availability, parameter availability and preset value ranges can only be set using the DC-One Editor PC application.

Input Channel Hi-Pass Filter



Use the < Select > buttons to make the top line of the Edit screen active and the Value Up and Down buttons to navigate to the Input Hi-Pass screen.



The first DSP block in the DC-One's signal flow is the stereo Hi-Pass Filter. In any sound reinforcement system, the Hi-Pass filter is crucial for maximizing the efficiency and performance of the PA system. Both analog and digital audio sources can include significant sub-sonic (infra-sonic)

program material and artifacts. Audio frequencies below the threshold of human hearing can still be present at the amplifier inputs, and the amplifiers and loudspeakers will do all they can to reproduce them; at a great cost of power and efficiency.

Hi-Pass filters can set a frequency, below which, signals will be attenuated or reduced. The cut-off frequency selected for the hi-pass filter – below which the frequencies will be attenuated - will vary depending on the program material and connected loudspeaker system. For example, full range music can produce frequencies down to the theoretical limit of human hearing (20 Hz), some acoustic music can be limited to frequencies above 60 Hz, and voice-only reproduction is limited to much higher frequencies. Hi-pass filter applications and settings will be determined by the needs of the given DC-One preset selected for the program material and sound reinforcement system.

The DC-One Hi-pass filter offers several response curves, or slopes, to suit the needs of the given application. Select the curve that best meets the needs of your particular situation:

Freq

The cut-off frequency for the Hi-Pass filter. The frequency range is from 20 Hz to 200 Hz and is adjustable in 1 Hz increments. Select the frequency setting that is appropriate for the attenuation slope selected and type of program material.

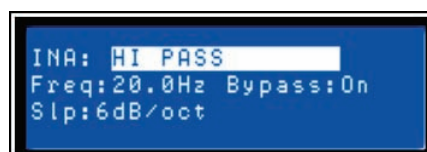

Bypass

No sub-sonic or low-frequency filtering is applied. Use this to bypass the Hi-Pass filter.

Slp

Slope or degree of attenuation.

- 6dB/Oct - A very gentle attenuation of frequencies below the selected cut-off frequency; good for acoustic music that is generally within known frequencies, but may drop below; without much energy.
- 12dB/Oct - Steeper attenuation of frequencies below the selected cut-off frequency; useful when unexpected low-frequency material may be encountered. When 12dB/Oct is selected, **Q band** is available - from 0.4 Oct to 2.0 Oct.

Input Channel Parametric EQ



PEQ

Use the < Select > buttons to make the top line of the Edit screen active and the Value Up and Down buttons to navigate to the Input PEQ screen.

PEQ

The DC-One provides a stereo nine-band multi-mode filter generically referred to as the Input PEQ (Parametric Equalizer). The Input PEQ is a very powerful and complex set of multi-mode filters. Care must be given configuring these filter bands, as they interact and can produce unexpected results. Using the DC-One Editor PC application is strongly recommended to set all but the most simple eq curves.

Each band of the Input PEQ can be configured for a specific filter mode, frequency, slope or Q and gain setting. Attention must be paid to the ultimate output gain through the rest of the DC-One's audio path, as it is possible to boost frequency ranges to the point where the internal or external audio paths of the system may be clipped. Monitoring the output VU meters of the DC-One's output channels will indicate internal clipping; the input meters of connected amplifiers should do the same.

To bypass any band of the DC-One's Input PEQ multi-mode filter bank, set the desired band's gain to 0.0 dB. This will have the effect of bypassing the selected filter band.

The following section details the type of filters that can be selected for each of the Input PEQ's 9 bands and their parameters:



Low-shelf

The Low-shelf filter is a “hinge” type; in that frequencies *below* its frequency setting can be Type:LOSLV boosted or cut; hinging on the cut-off **Frequency**. The amount of boost or cut (**Gain**), and the extent of width of the filter’s transition band (**Slope**), are determined by the low-shelf filter’s settings. (See Response/Q and Gain.)

Use the < Select > buttons to navigate to the filter setting you wish to adjust, and the Value Up and Down buttons to alter these settings. Press the Value Up and Down buttons once to increment values by one unit, or press and hold to scroll rapidly through available values. (Values do not wrap around.)

Hi-shelf

The Hi-shelf filter is a “hinge” type; in that frequencies above its frequency setting can be Type:HISLV boosted or cut; hinging on the cut-off **Frequency**. The amount of boost or cut (**Gain**), and the width of the filter’s transition band (**Slope**), are determined by the hi-shelf filter’s settings. (See Response/Q and Gain.)

Use the < Select > buttons to navigate to the filter setting you wish to adjust, and the Value Up and Down buttons to alter these settings. Press the Value Up and Down buttons once to increment values by one unit, or press and hold to scroll rapidly through available values. (Values do not wrap-around.)

PEQ

PEQ is shorthand for Parametric Equalizer. A parametric equalizer has three parameters that Type:PEQ determine the frequencies that are affected by it; Center **Frequency**, **Q** (filter-width) and **Gain**. Parametric filters are ideal for identifying, isolating and correcting problematic frequency ranges.

The Frequency parameter determines the center of a range of frequencies that will be adjusted by the PEQ. The Q parameter will determine the range of frequencies adjacent to the center frequency that will also be effected; the greater the value, the smaller the range of adjacent frequencies that will be effected. The gain parameter determines the amount of boost or cut that is applied to the frequencies that are affected by the filter.

Use the < Select > buttons to navigate to the filter setting you wish to adjust, and the Value Up and Down buttons to alter these settings. Press the Value Up and Down buttons once to increment values by one unit, or press and hold to scroll rapidly through available values. (Values do not wrap-around.)

Low-pass

The Low-Pass filter determines the ultimate high frequency that your sound reinforcement Type:LOPASS system is allowed to reproduce; given the capabilities of amplifiers, speakers and transducers. The low-pass filter is useful for reducing excessive high frequency energy that can create stress on high frequency transducers and listener fatigue.

Available parameters are **Frequency** and **Slope**. The frequency parameter determines the frequency above which frequencies will be attenuated. The slope determines how quickly frequencies above the cut-off frequency will be attenuated. (See response curve.)

Use the < Select > buttons to navigate to the filter setting you wish to adjust, and the Value Up and Down buttons to alter these settings. Press the Value Up and Down buttons once to increment values by one unit, or press and hold to scroll rapidly through available values. (Values do not wrap-around.)

Hi-pass

The Hi-Pass filter determines the ultimate low frequency that your sound reinforcement Type:HIPASS system is allowed to reproduce; given the capabilities of amplifiers, speakers and transducers. Keep in mind that the DC-One signal path already includes a hi-pass filter prior to the Input PEQ DSP block. Settings to this filter in most configurations may be redundant or interactive with the initial Hi-Pass filter.

Available parameters are **Frequency** and **Slope**. The frequency parameter determines the frequency below which frequencies will be attenuated. The slope determines how quickly frequencies below that will

be attenuated. (See response curve.)

Use the < Select > buttons to navigate to the filter setting you wish to adjust, and the Value Up and Down buttons to alter these settings. Press the Value Up and Down buttons once to increment values by one unit, or press and hold to scroll rapidly through available values. (Values do not wrap-around.)

Input A/B Parametric EQ					
Band	Type	Frequency	Slope	Resp / Q	Gain
HIPASS	HIPASS	20 Hz...20000 Hz	6dB/oct. 12dB/oct.	0.40 to 2.00	
PARA EQ BAND 1-9	LOSLV	20 Hz...20000 Hz	6dB/oct. 12dB/oct.		-15.0dB to +15.0dB
	HISLV	20 Hz...20000 Hz	6dB/oct. 12dB/oct.		-15.0dB to +15.0dB
	PEQ	20 Hz...20000 Hz		0.40 to 20	-15.0dB to +15.0dB
	LOPASS	20 Hz...20000 Hz	6dB/oct. 12dB/oct.	0.40 to 2.00	
	HIPASS	20 Hz...20000 Hz	6dB/oct. 12dB/oct.	0.40 to 2.00	

Input Channel GEQ (Graphic Equalizer) (available soon)

Use the < Select > buttons to make the top line of the Edit screen active and the Value Up and Down buttons to navigate to the Input GEQ screen.

The DC-One's input signal path includes a stereo 31-band graphic equalizer after the stereo 9-band PEQ in the signal path. This DSP block can be used for very precisely identifying, isolating and correcting problematic frequency ranges.

Keep in mind that changes to the Input GEQ will be interactive with adjustments made in the Input PEQ. Unexpected results can occur.

Press the < Select > buttons to move the cursor down into the GEQ frequency adjustment field. Subsequent presses of the < Select > buttons will move the cursor forward or backwards through the frequency adjustment field; from band to band. The selected frequency's "fader" is highlighted in the display. As each band is selected, its center frequency and current cut/boost setting is displayed on the top line of the LCD display.

To adjust the amount of boost or cut for a selected frequency band, select the band with the < Select > buttons and press the Value Up or Down buttons as required. The LCD display will reflect your changes by moving the selected frequency band's "fader" up or down.

To exit the Input GEQ edit screen, press the Input GEQ button, use the < Select > buttons to again highlight the top line of the edit screen display or press any other DSP block button.

Input Delay



DC-One offers an input delay that is useful for compensating for different arrival times of sound originating from loudspeakers that are closer or further away from the listener than others. A technique known as the *Haas Effect* allows the operator to create the illusion that all of the sound has originated from the stage even though additional speakers have been placed around the room.

Available Input Delay parameters are **Delay**, **Units** and **Bypass**. The Delay parameter allows the user to determine the Delay time values (-200.00ms to +700.00ms.) and the Bypass parameter simply toggles between On/Off.

To access the Input Delay, press the *Delay* button found on the input processing menu. Subsequent button presses will toggle the display between Input A and Input B. Input delay parameters are accessed using the <SELECT> button to navigate between Delay and Bypass using the VALUE up/down keys to adjust values.



Illustration 5.1: Input B Delay is set to 75 feet. In this illustration, speaker array B is said to be 75 feet in front of Main speaker array A. The effect of air temperature is also automatically calculated for the total delay time using the Temperature value entered in the Setup Menu.

Routing

Input selections (In-A, In-B or In-A+B) can be applied to any or all of DC-One's six outputs. Choose a desired output channel from the output menu and press the Edit button to scroll to the Routing window using the Value up/down arrows.

Using the <SELECT> key to navigate to the Source parameter, apply a desired input selection to a selected output channel using the VALUE up/down keys to choose between inputs (In-A, In-B or In-A+B).



Cross-Over (Output Channels)



X-OVER

The DC-One's crossover is an advanced frequency division process that is accomplished by applying a variety of high-pass and low-pass filters to a predetermined set of crossover points.

Speaker systems are generally made up of several drivers that are dedicated to a specific range of frequencies that result in the efficient reproduction of the audio spectrum and a smooth sound. The DC-One crossover routes frequencies to the appropriate drivers to accurately reproduce sound. The crossover network can also be used to insure that low-frequency energy is not accidentally routed to the mid-range or tweeter drivers that may result in potential damage.

Available DC-One crossover parameters are **Type** and **Frequency**.



X-Over

To access the Crossover screen, press the X-Over button found on the output processing menu. Subsequent button presses will toggle the display between OUT1 to OUT6. Use the <SELECT> button to navigate between the Low Pass/parameters. Adjust the values of each parameter using the up/down VALUE arrows.

The DC-One Crossover offers a variety of HiPass and LoPass filters depending on the configuration output selected along with a variety of selectable filters and frequency ranges that are adjustable using the up/down VALUE arrows.

Type

Type offers list of selectable slopes/response Q's

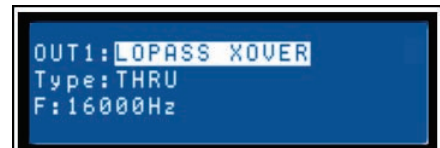

- Thru
- 6dB
- 12dB/ 0.5Q - 2.0Q
- Bessel: 12 dB, 18 dB or 24 dB
- Butterworth: 12dB, 18dB or 24 dB
- Linkwitz-Riley: 12dB or 24 dB

Frequency

Frequency offers a selectable frequency range from 20.0 Hz to 20,000Hz.

Hi-Pass/Lo Pass

The DC-One Hi-Pass and Lo-Pass filters are determined by selecting the **Type** from the list of parameters, (see list above) and by choosing a frequency range between 20.0 Hz to 20,000Hz. (See above)

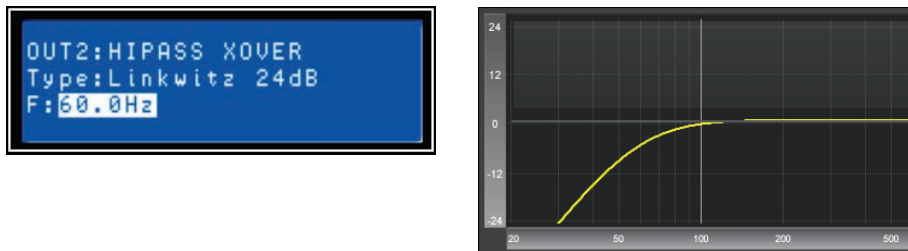

Illustration 5.2: Here the HiPass Output 2 Crossover is set to Linkwitz-Riley 24dB with the frequency set to 60.0Hz

The crossover filter generally consists of a low pass filter in one channel and a high pass filter in the adjacent channel. This is where the frequency x-over filter's Hi-Pass parameters are set. The Hi-Pass frequency parameters are linked to the corresponding Lo-Pass frequency parameter unless in Full Edit Mode or using the Configuration option. Please refer to the Configuration section of this manual for details on the effect different Configurations have on channel linking.

The Type parameter defines the filter characteristics of the crossover Hi-Pass filter. Different slopes and filter responses (6dB, 12dB with different **Q** values, Bessel, Butterworth, Linkwitz-Riley) are available and the filter can be bypassed. Again, the Hi-Pass frequency parameters are linked to the corresponding Lo-Pass frequency parameter depending on the Configuration that is currently being used. High pass frequencies are set with a pre-determined frequency that attenuates frequencies below (the crossover point). On the contrary, a Low Pass filter passes frequencies below the crossover point and attenuates those above.

Crossover Alignment Delay

To access the Crossover Delay screen, press the *X-Over* button found on the output processing menu. Subsequent button presses will toggle the display between OUT1 to OUT6. Use the <SELECT> button to navigate between the Crossover parameters. Adjust the values of each parameter using the up/down VALUE arrows.



- **Delay** - Use this parameter to compensate for physical offsets of the acoustic centers of transducers within a loudspeaker cabinet. For example, due to cabinet construction, the acoustic center of a high frequency transducer may be mounted behind or in front of the acoustic center of the low frequency transducer. The Delay parameter can align the audio signal between the multiple transducers within the loudspeaker.
- **Polarity** - The polarity of the audio signal can be inverted using this control.

- **Unit** - The user may select between time and distance display. Distances are automatically converted into delay times. This calculation also includes the influence of the environmental temperature based on the Temperature parameter in the Setup Menu.
- **Bypass** - Setting this to On disables the Crossover Delay.

Parametric EQ (Output Channels)



Pressing the PEQ button places the current preset in Edit mode and jumps the LCD screen to a pre-selected parametric EQ (bands 1-5). Subsequent button presses advances the display to the next output channel (OUT1 to OUT6). Use the <SELECT> key to navigate between the PARA EQ BAND (1-5), Type, Frequency, Q and Gain parameters. Adjust the values of each parameter using the up/down VALUE arrows.



Output 1-6 Parametric EQ					
Band	Type	Frequency	Slope	Resp / Q	Gain
PARA EQ BAND 1-5	LOSLV	20 Hz...20000 Hz	6dB/oct. 12dB/oct.		-15.0dB to +15.0dB
	HISLV	20 Hz...20000 Hz	6dB/oct. 12dB/oct.		-15.0dB to +15.0dB
	PEQ	20 Hz...20000 Hz		0.40 to 20	-15.0dB to +15.0dB
	LOPASS	20 Hz...20000 Hz	6dB/oct. 12dB/oct.	0.40 to 2.00	
	HIPASS	20 Hz...20000 Hz	6dB/oct. 12dB/oct.	0.40 to 2.00	
	ALLPS1	20 Hz...20000 Hz			
	ALLPS2	20 Hz...20000 Hz		0.40 to 2.00	

Delay (Output Channels)



DC-One's output delays can be applied to output channels OUT1 - OUT6 and can be used to compensate for the positioning of cabinets or speaker arrays relative to each other or the original sound source.

The Delay parameter determines the delay time of the corresponding channel or the distance between different loudspeaker clusters. The delay time or physical distance is displayed in milliseconds, microseconds, feet, inches, meters, or centimeters.

To access the Delay screen, press the *Delay* button found on the output processing menu. Subsequent button presses will toggle the display between OUT1 to OUT6. Use the <SELECT> key to navigate between Delay (-200.00ms to 680.00ms) and Bypass (on/off). The values for each parameter can be adjusted using the up/down VALUE arrows.

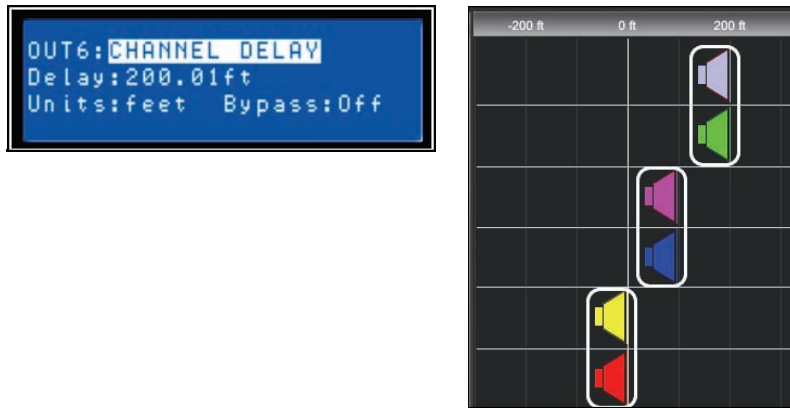

Illustration 5.3: Here Output 5 and 6 are linked and their delay is set to 200 feet. Output 3 and 4 are also linked and set to 100 feet. In this configuration, speaker outputs 5 and 6 are said to be 200 feet in front of Main speaker output array 1 and 2. The effect of air temperature on the actual delay time will also be automatically calculated based on the Temperature Parameter in the Setup Menu. See Output Linking.

Channel Level (Output Channels)



The Channel Level is used to adjust master output levels. To access the Channel Level screen, press the Level button found on the output processing menu. Subsequent button presses will toggle the display between OUT1 to OUT6. Use the <SELECT> button to navigate between the selectable Level parameters (-100.0dB to +6.0dB). Adjust the value by using the up/down VALUE arrows.



Channel Limiter (Output Channels)



DC-One's output channel limiters prevent audio signals from exceeding a set level. Press the Level button to change the output channel. **Hold-down the Level button for some seconds** - you will then be presented with the Limiter screen. Use the < SELECT > key to navigate between Threshold (-9.0 dBu to + 21.0 dBu), Release (50.0ms to 300.0 ms), Amp (preset values for specific power amplifiers) and Bypass (on/off). Adjust the values of each parameter using the up/down VALUE arrows.

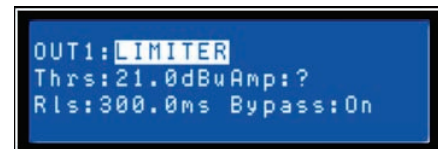

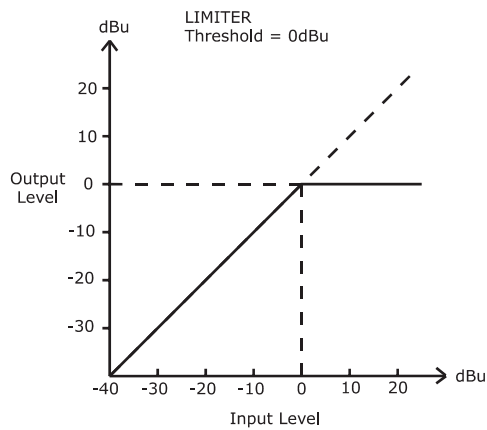

Limiter threshold values are determined by the amplifiers and loudspeakers that are used in the system. One important consideration in setting the limiter threshold value is the input sensitivity and gain of the connected amplifiers. Because different amplifiers can have different sensitivities, it is common to need to calculate the limiter offset to a factory preset based on the amplifier sensitivity. The DC-One offers a unique solution to this problem with the **Amp** parameter. All DC-One Factory Presets include limiter threshold values. You may use the **Amp** parameter to select the model of Electro-Voice amplifier that you are using and the limiter threshold offset will be automatically calculated based on the amplifier gain and sensitivity. When an amplifier is selected from the list, the actual Threshold parameter will be locked to ensure that

proper settings are maintained. It is very important to ensure that the proper amplifier is selected from the list, as an improper selection can result in incorrect Limiter settings for your system and may result in system damage. If a non-Electro-Voice amplifier is used in the system, selecting “Other” from the amp list will allow the Threshold setting to be directly edited, however, the amplifier documentation should be consulted so you can calculate your limiter offset (if any) as needed. The **Amp** parameter is only available when using a Factory Preset.

Amp Type
Q44
Q66
CP1200
CP1800
CP2200
CP3000S
CP4000S
P1200 (0dBu, +6dBu, +26dB)
P2000 (0dBu, +6dBu, +26dB)
P3000 (0dBu, +6dBu, +26dB)
TG-5 (0dBu, +32dB, +35dB)
TG-7 (0dBu, +32dB, +35dB)

6 Setup

The **Setup** menu allows access DC-One’s global parameters on the LCD screen. This is where preferences for many functions can be set or adjusted. Pressing the **Setup** button brings up the first Setup window. Use the VALUE up/down arrows to scroll through the Setup menu: Use the <SELECT> buttons to scroll to Setup parameters to make adjustments using the VALUE up/down buttons.

IMPORTANT NOTE



To achieve optimum performance and guard against damage to the processor, your sound system or yourself, please read, understand and follow all of the directions contained in this Owner’s Manual. Failure to do so may result in improper performance, loss or injury.

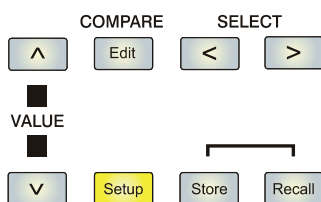

6.1 Setup Menus

Configuration

Configuration window is where you can select the desired setup for your system. Use the <SELECT> key to navigate to the Mode parameter to choose the best setup for your system. Use the up/down VALUE arrows to choose between:



1. 2 Way Stereo + FR
2. 3 Way Stereo
3. 4 Way + FR
4. 5 Way + FR
5. Free Configuration
6. 3 Way Stereo-Mono Sub+FR
7. 4 Way Stereo-Mono Sub+LR

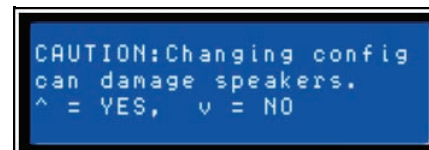

For more on Configuration Setup, see page 36.

Caution



Before operating the sound reinforcement system, and any time a new preset is recalled, check the configuration display to make sure that it is appropriate for your system and that connections to your system are correct for the current configuration. Failure to do so could cause unexpected results or damage to the system or its components.

Input

This window is where the global input mode is set. Use the <SELECT> key to navigate to the MODE parameter. Use the up/down VALUE arrows to choose between **Analog** and **Digital** input.



LCD

LCD settings allow the user to adjust the contrast preferences of the LCD screen to compensate for different lighting conditions that may be encountered within different venues. Use the <SELECT> key to navigate to the CONTRAST parameter to choose the best setup for your system. Use the up/down VALUE arrows to choose between: - 10 to + 10 LCD contrast.



Limiter Units

In this window you can select between dBu and Volt for Limiter units. Use the <SELECT> key to navigate to the UNITS parameter.



Metering

Users can set their **VU** metering preferences here. Use the <SELECT> key to navigate to the MODE parameter. Use the up/down VALUE arrows to choose between Normal Fast, Peak Hold and Slow Decay.

INPUT	
Clip <input type="checkbox"/>	<input type="checkbox"/> Clip
+6 <input type="checkbox"/>	<input type="checkbox"/> +6
+3 <input type="checkbox"/>	<input type="checkbox"/> +3
0 <input type="checkbox"/>	<input type="checkbox"/> 0
-6 <input type="checkbox"/>	<input type="checkbox"/> -6
-12 <input type="checkbox"/>	<input type="checkbox"/> -12
-20 <input type="checkbox"/>	<input type="checkbox"/> -20
-30 <input type="checkbox"/>	<input type="checkbox"/> -30
A	B



Temperature

This parameter is used to calculate the speed of sound for converting delay times into distance. Use SETUP Temperature to adjust number of degrees and type of temperature base. Use the <SELECT> key to navigate to the TEMP and UNITS parameters. Use the up/down VALUE arrows to choose between - 4.0 F to 140.0 F. The UNITS parameter lets the user choose between Fahrenheit and Celsius.



Note: Sound travels at different speeds depending on the density of the surrounding air it is traveling through. Cold air is denser than warm air thus, travels slower than it would if the air was warmer. Temperature can have a major influence with greater distances, particularly with respect to widely separated speaker arrays surrounding the audience for example. Temperatures might vary wildly between an indoor environment and an outdoor evening environment for example.

$$V = 331\text{m/s} + (0.6\text{m/s/C}) * T$$

The speed of sound at room temperature is 346 meters per second. At freezing temperatures sound travels at 331 meters per second. **V** is the speed of sound and **T** is the temperature of the air. This formula finds the average speed of sound for any given temperature (celcius). The speed of sound is also affected by other factors such as humidity and air pressure.

Editing

Editing mode is where the Edit Mode (Standard Edit or Full Edit) is set. The DC-One defaults to **Standard Edit** mode wherein, input and output channel parameters are appropriately linked. (See page 44 for more.) In **Full Edit** mode, no parameter links are enforced, regardless of the configuration selected. Use the <SELECT> key to navigate to the EDITING parameter to choose your editing preferences.

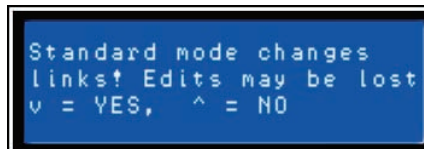

Lock - Front Panel Access

A lockout mode has been provided for the installer to protect the system settings from being modified by a user. This can be set from the front panel or from the GUI software.

From the front panel

Use the <SELECT> key to navigate to the Lock menu. Use the VALUE key to choose your four digit code. Then use the <SELECT> key navigate to the Store parameter, to lock or unlock front panel editing.



From the GUI

Open the DC-One's GUI and choose Front Panel Access from the Window pull-down menu. Doing so will bring up the Front Panel Access GUI that will present the unit's currently loaded state including preset (U## or F##), DSP Blocks and Parameters. Any or all of the DC-One's DSP Blocks and/or individual parameters within the DSP blocks can be locked or hidden from this window by selecting the corresponding box to engage the lock icon. For example, an installer may chose to lock and hide all Limiter parameters, lock all Crossover parameters but leave them visible, and lock the last 5 Input PEQ filters, leaving the first 4 available for the user to edit and modify.

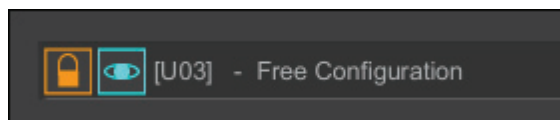

System

This window displays the firmware version currently running on the DC-One.



RS-232 Port

An RS-232 (DB-9 or 'D-Sub') connection is provided on the back panel to link to another DC-One to enable Master/Slave operation. Use the <SELECT> key to navigate to the MODE parameter and use the up/down VALUE arrows to choose between RS-232 and Contacts.



Contacts allow control messages to select individual presets (per pin 1-9) using a remote device. The additional CONTACTS parameter is used as a display only and corresponds to the binary values of individual pins, ie - on/off.

For more on this see **Relay Contact Closure** on page 17.

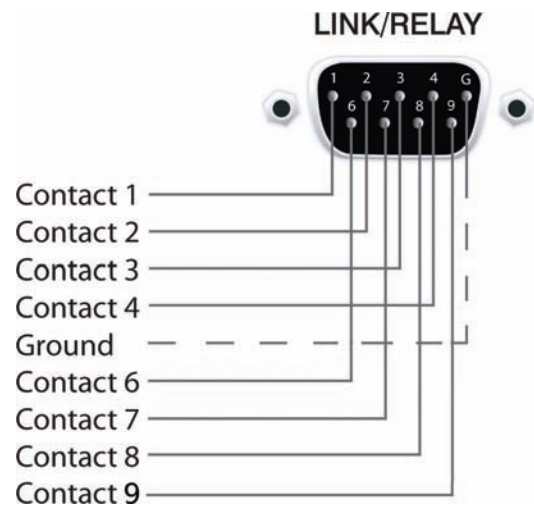

7 Configurations of the DC-One

The DC-One offers 7 pre-defined configurations. A configuration is a basic setting that includes the routing of inputs and outputs, the function of the outputs (Sub, Lo, Mid, Hi, Full Range) including basic x-over filter settings, and different channel/parameter linking schemes.

The active configuration is defined by the selected program i. e., each program is based on a specific configuration which is also displayed next to the program number and program name.

Each output employs two X-Over filters that can be assigned to a variety of filter types and slopes. Each output channel provides 5 additional filters which can be used as parametric EQs, Low- / High-shelving filters, or Lo-Pass and Hi-Pass filters, and also as All-Pass filters. In addition to a gain control for adjusting the output level and a polarity switch, each output is monitored by a digital limiter with adjustable threshold, attack and release.

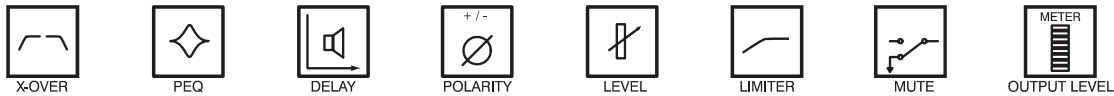

List and Detailed Description

- 2 Way Stereo + FR
- 3 Way Stereo
- 4 Way + FR
- 5 Way + FR
- Free Configuration - Full Edit 2 in 6 Out
- 3 Way Stereo - Mono Sub + FR
- 4 Way Stereo - Mono Sub + LF



Please use caution when changing configurations.



Note:

Not all parameters may be accessible in every preset and, depending on the configurations set by the contractor/installer, not all presets and/or preset values may be available for editing. Changes to preset availability, parameter availability and preset value ranges can only be set using the DC-One Editor PC application.

7.1 2-Way Stereo + Full Range

This configuration generally represents a 2-way stereo frequency crossover, where IN A serves as the left input channel and IN B as the right input channel. OUT 1 is the left Low-frequency output and OUT 2 is the left High-frequency output. OUT 4 and OUT 5 are the corresponding right Low-frequency and High-frequency output channels



Note: On Input channels, all Parametric EQ and Graphic EQ parameters are linked. For Output channels, linking applies to Crossovers, EQ, Delay Level and Limiter.

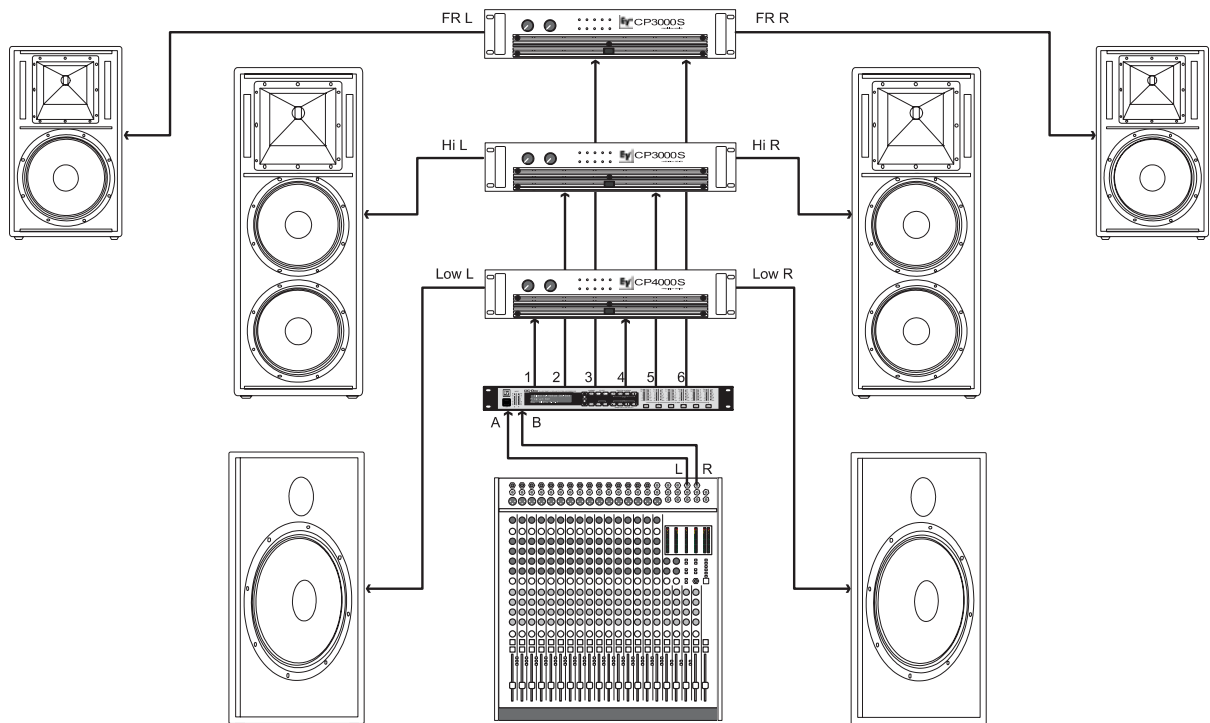
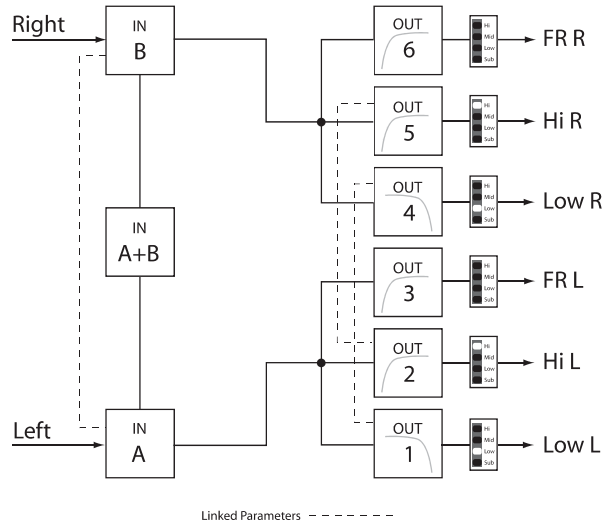

7.2 3-Way Stereo

This configuration represents a 3-way frequency crossover where IN A serves as the left input channel and IN B as the right input channel. OUTs 1 & 4 L/R are the Sub frequency channel, OUT 2 & 5 L/R are Low and Mid-frequency channels, 3 & 6 L/R are the High-frequency channels.



Note: On Input channels, all Parametric EQ and Graphic EQ parameters are linked. For Output channels, linking applies to Crossovers, EQ, Delay Level and Limiter.

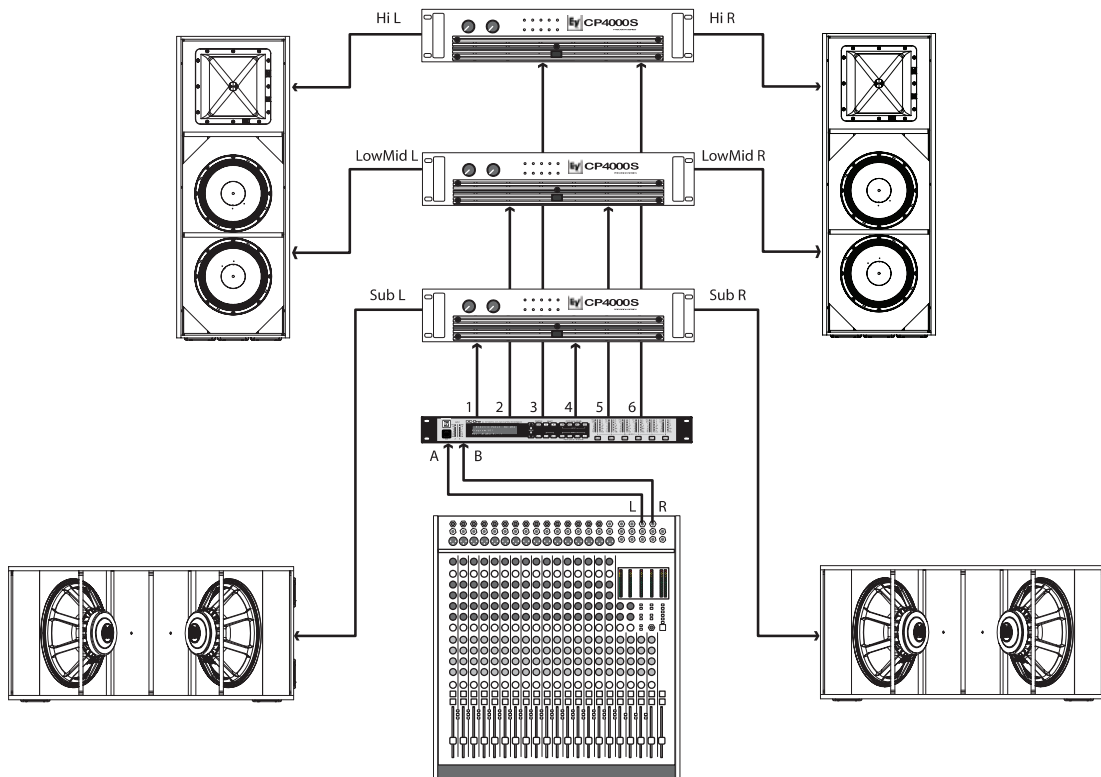
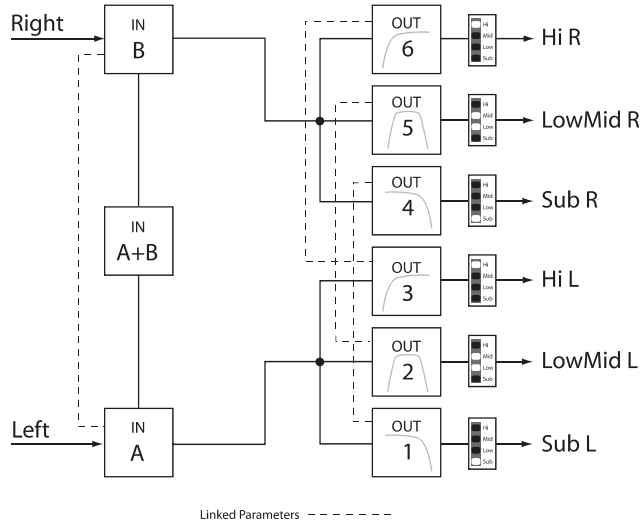

7.3 4-Way + FR

The 4-Way configuration is a monaural 4-way frequency x-over. Crossover channels are fed from IN A, full range channels are from IN B. OUT 1 is a mono Sub frequency channel, OUT 2 is a mono Low-frequency channel, OUT 3 is a mono Mid-frequency channel, and OUT 4 is the mono High-frequency. OUT 5 and OUT 6 are Full-range channels.



Note: On Input channels, all Parametric EQ and Graphic EQ parameters are not linked. For Output channels, linking applies to Crossover Highpass and Lowpass filters (see page 44 for details).

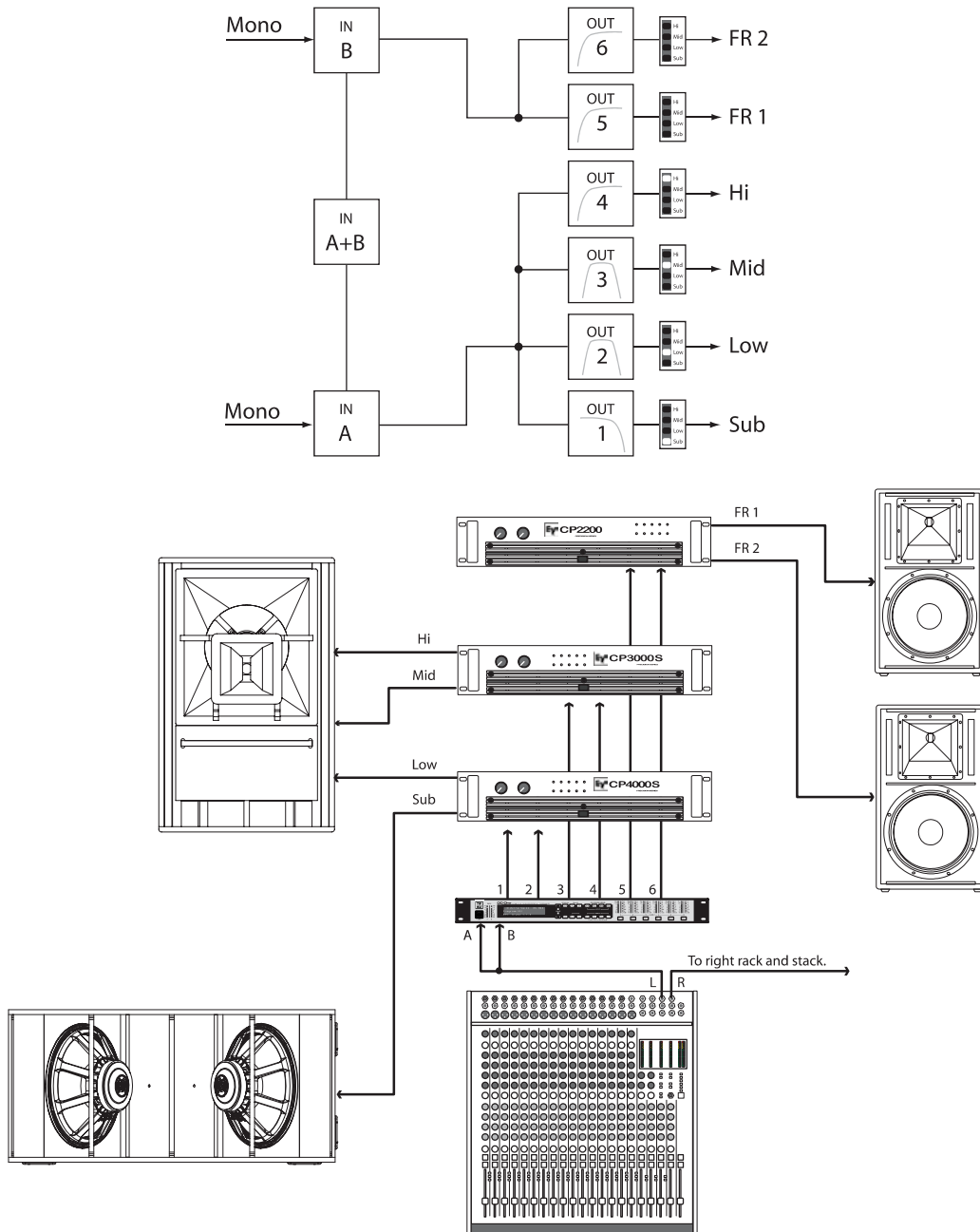

7.4 5-Way + FR

The 5-Way configuration is a monaural 5-way frequency x-over. Crossover channels are fed from IN A, full range channels are fed from IN B. OUT 1 is a mono Sub frequency channel, OUT 2 the mono Very Low-frequency, OUT 3 is the mono Low-frequency channel, OUT 4 is the mono Mid-Frequency channel, OUT 5 is the mono High-frequency channel and OUT 6 is the Full-range channel.



Note: On Input channels, all Parametric EQ and Graphic EQ parameters are not linked. For Output channels, linking applies to Crossover Highpass and Lowpass filters (see page 44 for details).

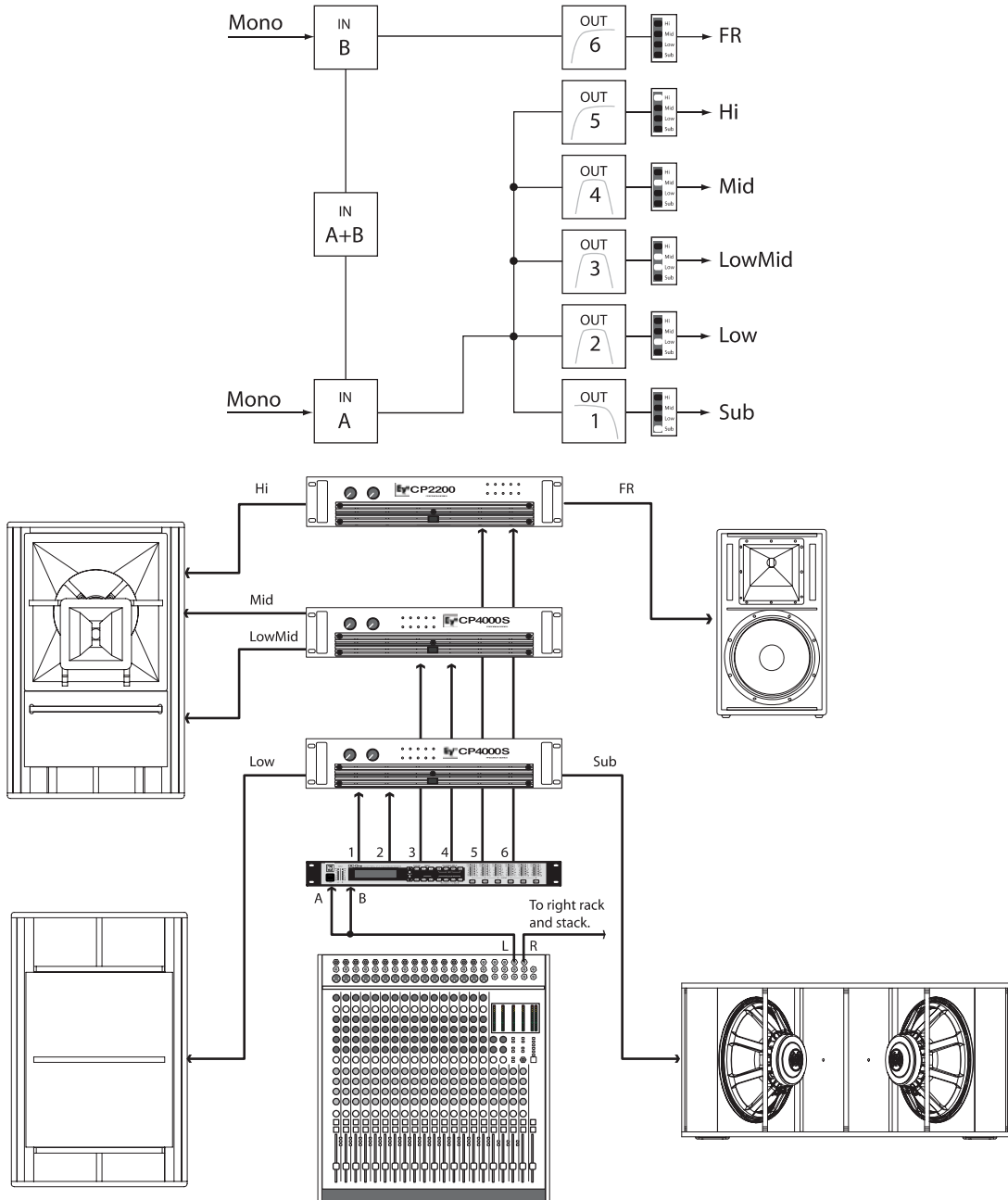

7.5 Free Configuration - Full Edit 2 In 6 Out

In this configuration, all 6 outputs are configured for full range operation. OUT 1, OUT 2 and OUT 3 get their signal-feed from IN A while OUT 4, OUT 5 and OUT 6 are fed from the input channel IN B. This configuration provides a “blank slate” for creating any custom routing and processing application.



Note: In this Configuration, no channels or parameters are linked.

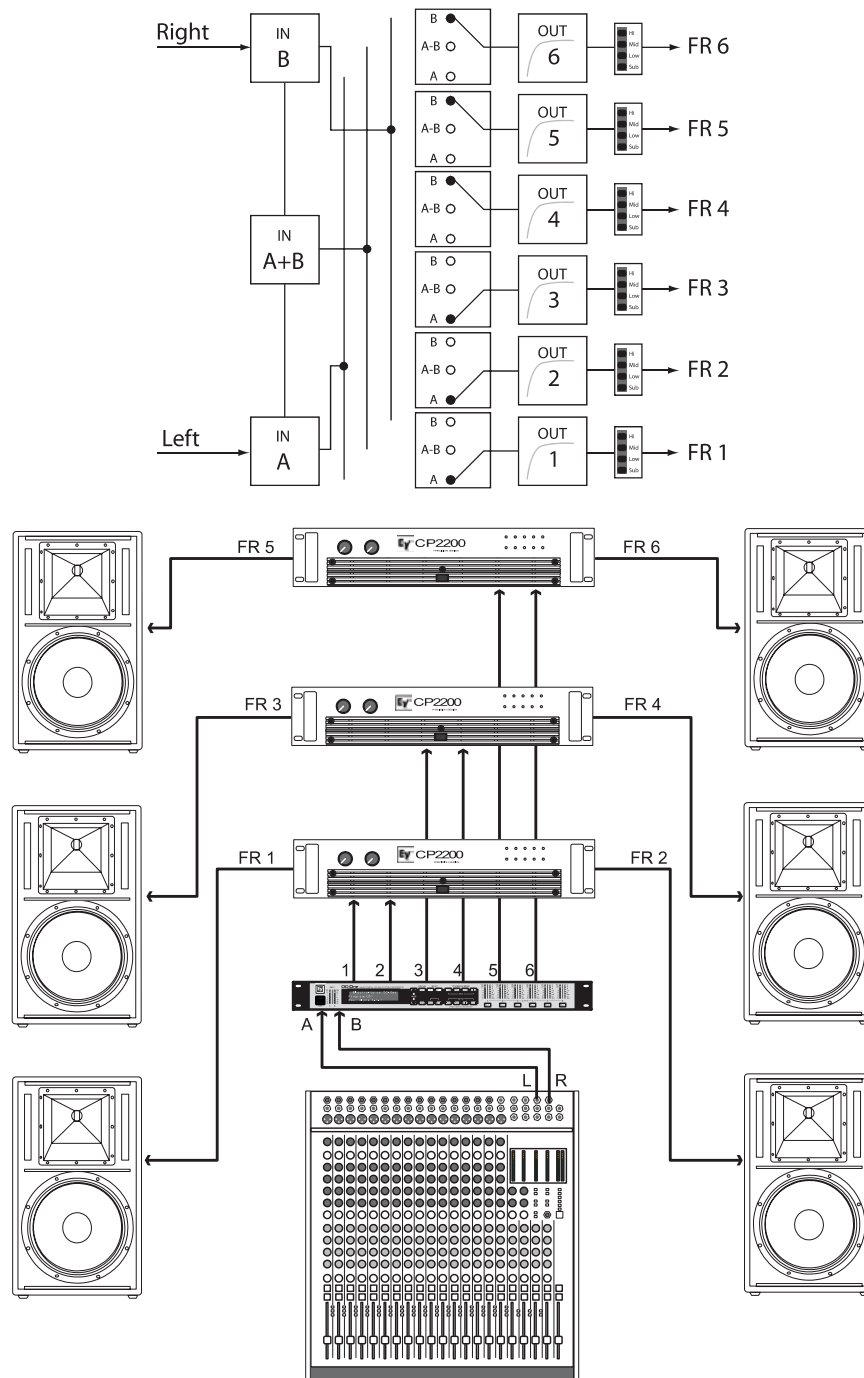

7.6 3-Way Stereo-MonoSub+FR

This 3-way configuration provides stereo crossover for Low-frequency and High-frequency devices and a summed mono feed for subs as well as a Full-range output. IN A serves at the left input and IN B serves as the right input. OUT 1 is a mono Sub-frequency channel, OUT 2 & 5 are L/R Low-frequency channels, OUT 3 & 6 are L/R High-frequency channels and OUT 4 is the Full-range channel.



Note: On Input channels, all Parametric EQ and Graphic EQ parameters are linked. For Output channels, linking applies to Crossovers, EQ, Delay Level and Limiter.

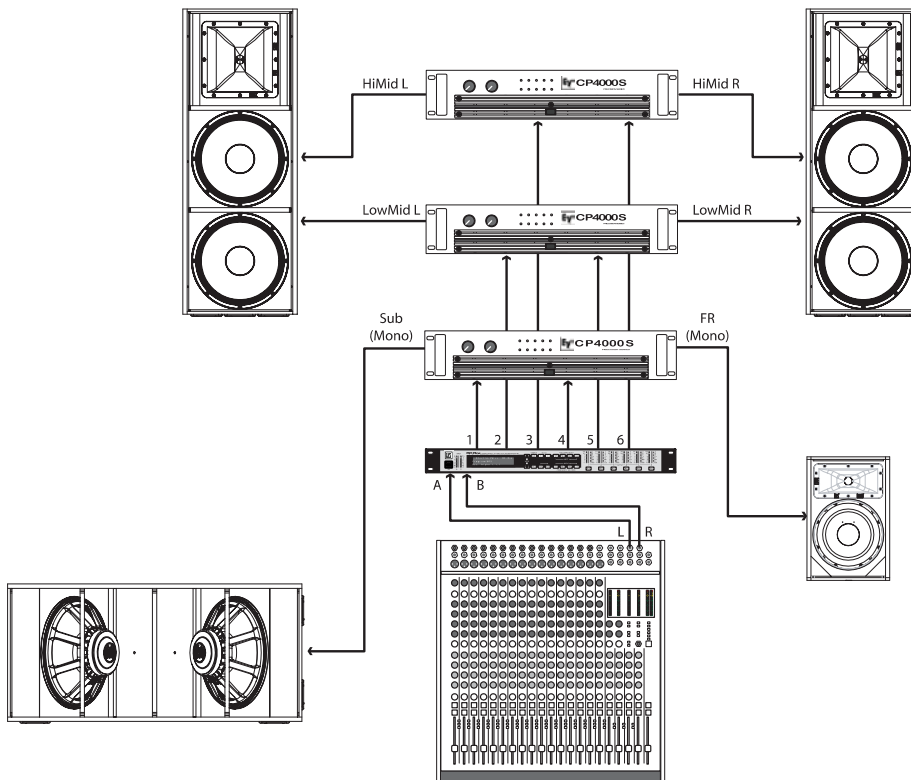
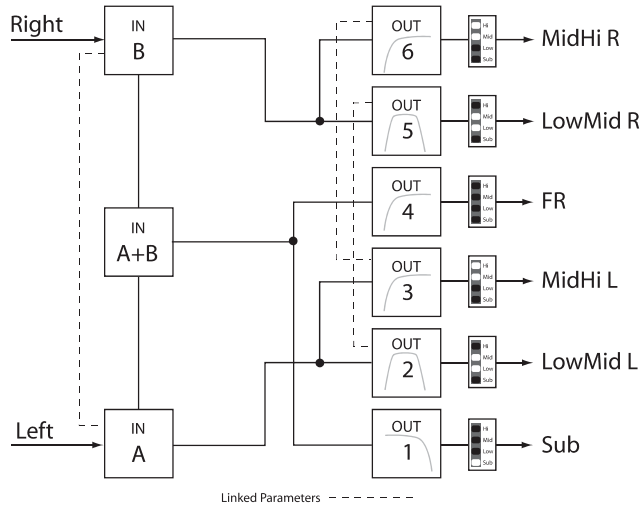

7.7 4-Way Stereo-MonoSub/LF

The 4-Way Stereo – MonoSub / LF configuration is a stereo 4-way frequency x-over. Mono Sub-frequency and Low-frequency channels are fed from IN A + IN B, Mid-frequency and High-Frequency left are fed from IN A, Mid-frequency and High-Frequency right are fed from IN B. OUT 1 is a mono Sub-frequency frequency channel, OUT 2 the mono Low-frequency channel, OUT 3 is the left Mid-frequency channel, OUT 4 is the left High-frequency channel, OUT 5 is the right Mid-frequency channel and OUT 6 is the right High-frequency channel.



Note: On Input channels, all Parametric EQ and Graphic EQ parameters are linked. For Output channels, linking applies to Crossovers, EQ, Delay Level and Limiter.

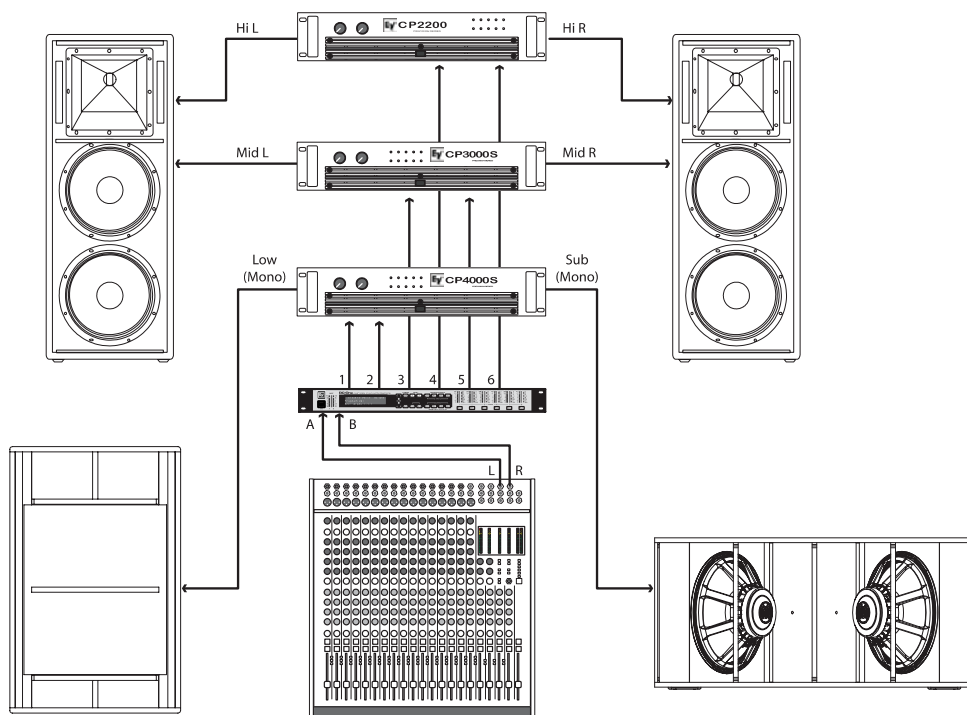
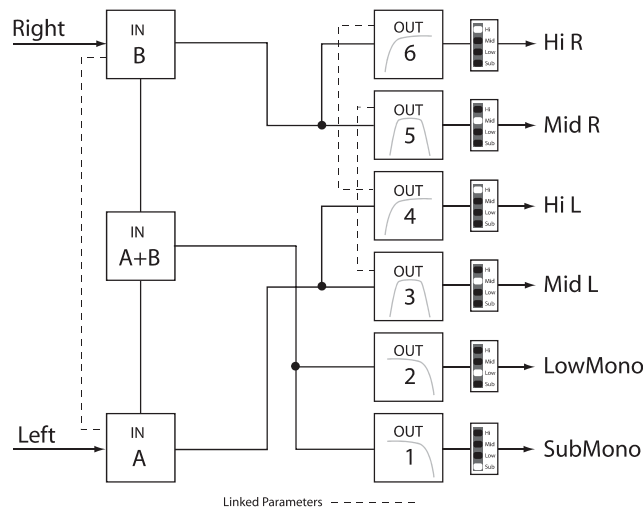

8 Operation Modes & Presets

DC-One Standard Configurations

This chart describes the channel assignments and linking schemes of the different configurations available in the DC-One.

Channels and parameters indicated with the same colors are linked. When making a change to one channel or parameter this will also affect the linked parameter or channel.

A dashed box around a Lo-pass/Hi-pass filter combination in adjacent channels indicates that these filters are linked. Changing the filter type and frequency of the Lo-pass filter will automatically change the linked Hi-pass filter on the adjacent channel and vice versa.

These links are only enforced while in Standard Edit Mode. When entering Full Edit Mode, all channel and parameter links are removed.

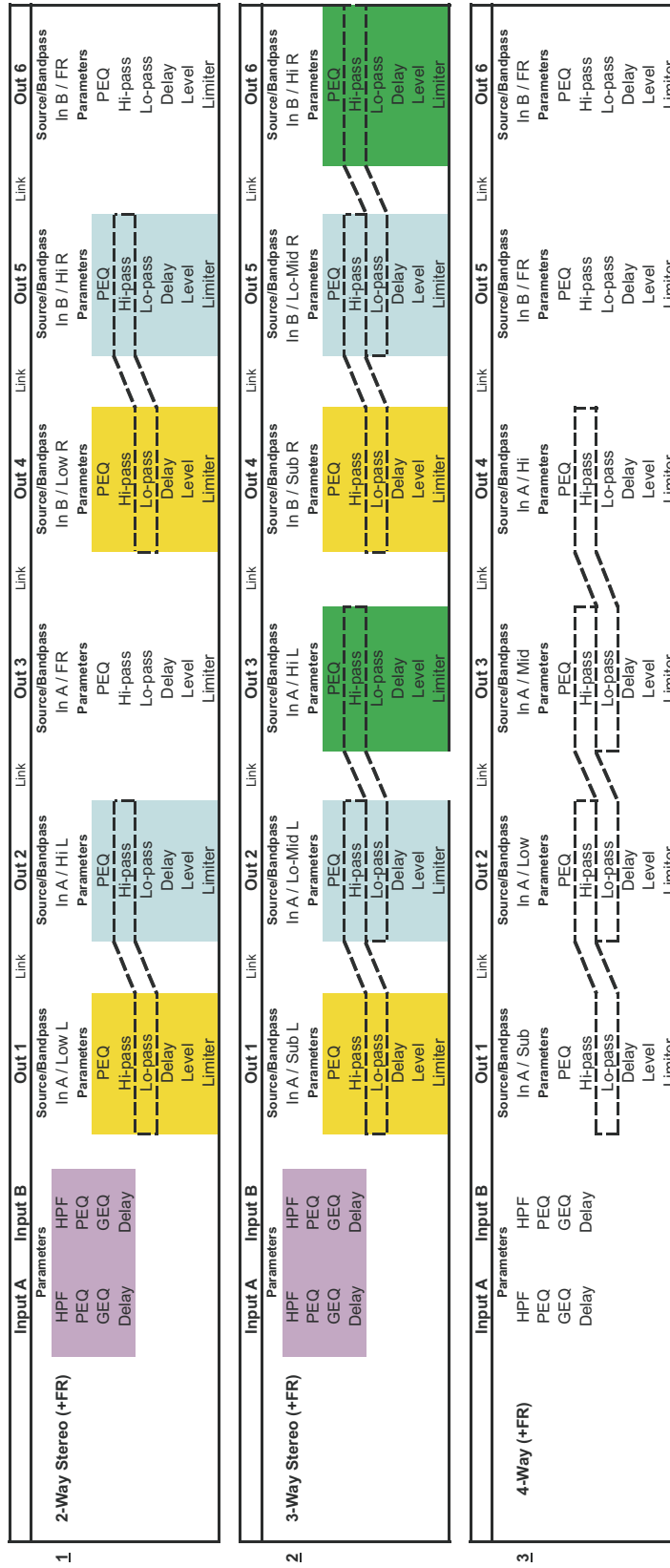

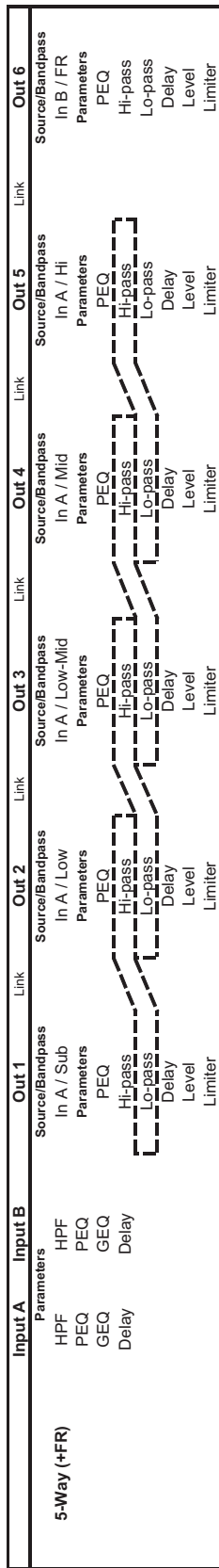

4

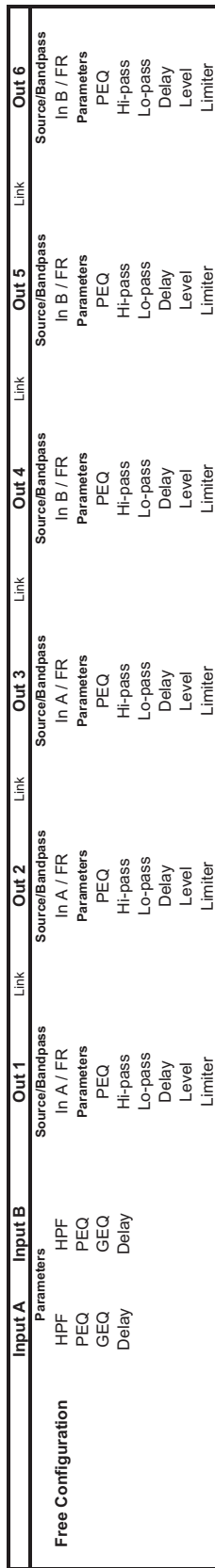

5

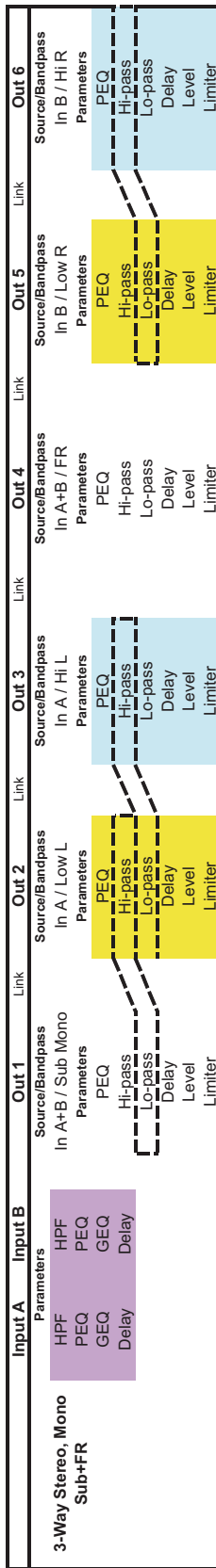

6

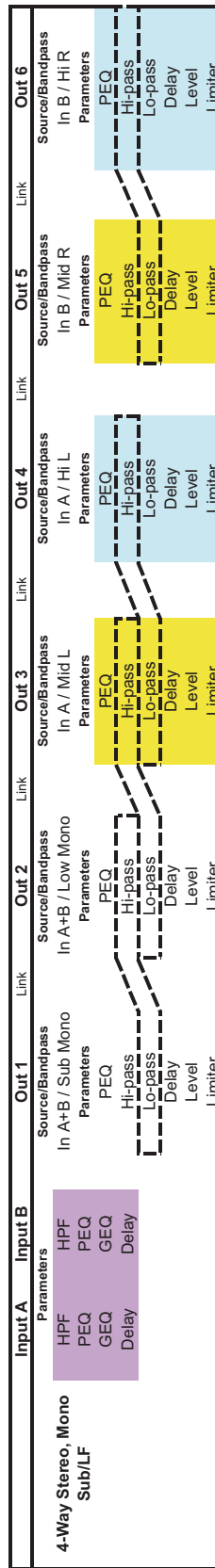

7

9 Specifications

General	
Mains Voltage	100-240 V AC, 50-60 Hz
Power Consumption	25 W
Audio	
Analog Inputs	2 x XLR IN, electronically balanced 2 x XLR THRU OUT, electronically balanced
Digital Inputs	1 x XLR AES/EBU IN
Nominal Input Voltage	1.23 V / +4 dBu
Maximum Input Voltage (Without -6dB Analog Pad Engaged)	8.7 V / +21 dBu
Input Impedance	10 k Ω
Common Mode Rejection	-80 dB @ 1 kHz (typical)
A/D Conversion	24-Bit Sigma-Delta
Outputs	6 x XLR OUT, electronically balanced
Nominal Output Voltage	1.23 V / +4 dBu
Maximum Output Voltage	8.7 V / +21 dBu
Output Impedance	50 Ω
D/A Conversion	24-Bit Sigma-Delta
Frequency Response	10 Hz...22 kHz (+/- 0.5 dB)
THD+N	< 0.01 % (band limited 22 Hz...22 kHz)
Dynamic Range	111 dB unweighted, band limited 22 Hz...22 kHz
Interfaces	
USB	USB Type B on front panel (PC Interface)
9-pin DSUB	Software Configurable for GPI Preset Recall or Master/Slave
Signal Processing	
Sample Rate	48 kHz
Data Format	24-Bit
Internal Processing	32-Bit Floating Point
Physical	
Dimensions (WxHxD)	14 x 14 x 1.75 inches (482.6 x 355.6 x 44.45 mm)
Weight (Net)	10.1 lb (4.6 kg)
Weight (Gross)	13.0 lb (5.9 kg)

Dimensions

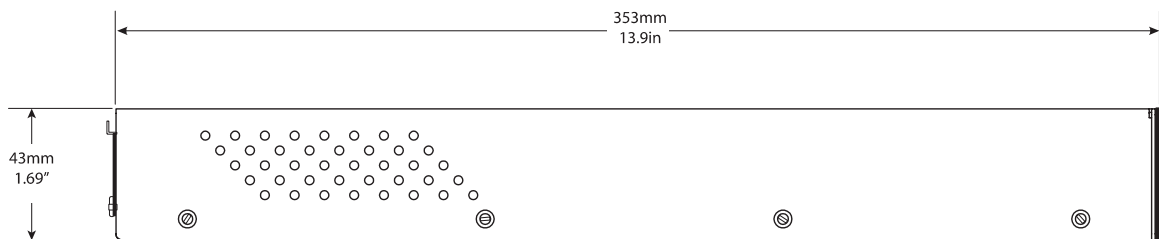
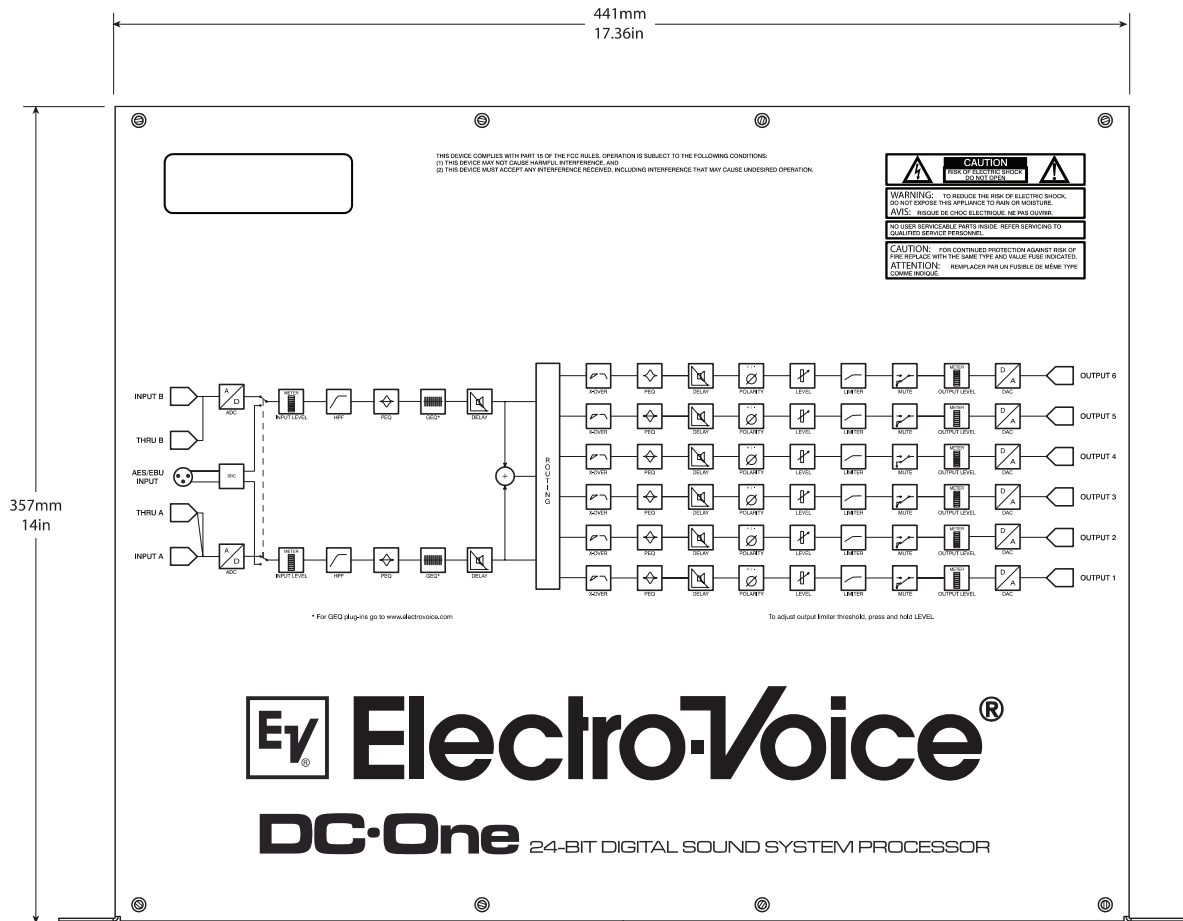
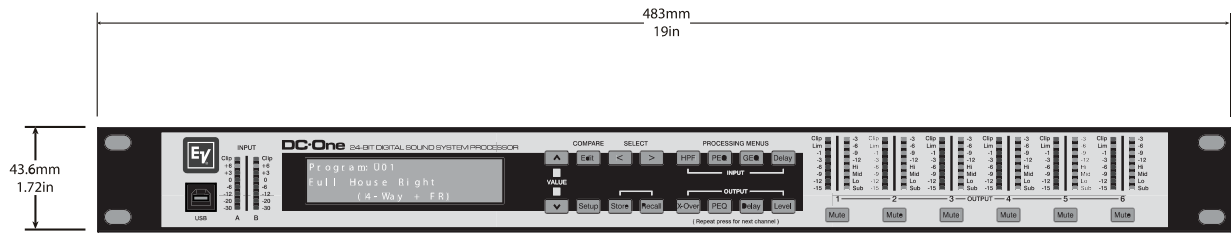

10 EQ Plot Images

10.1 6 dB PEQ Cuts Q Changes

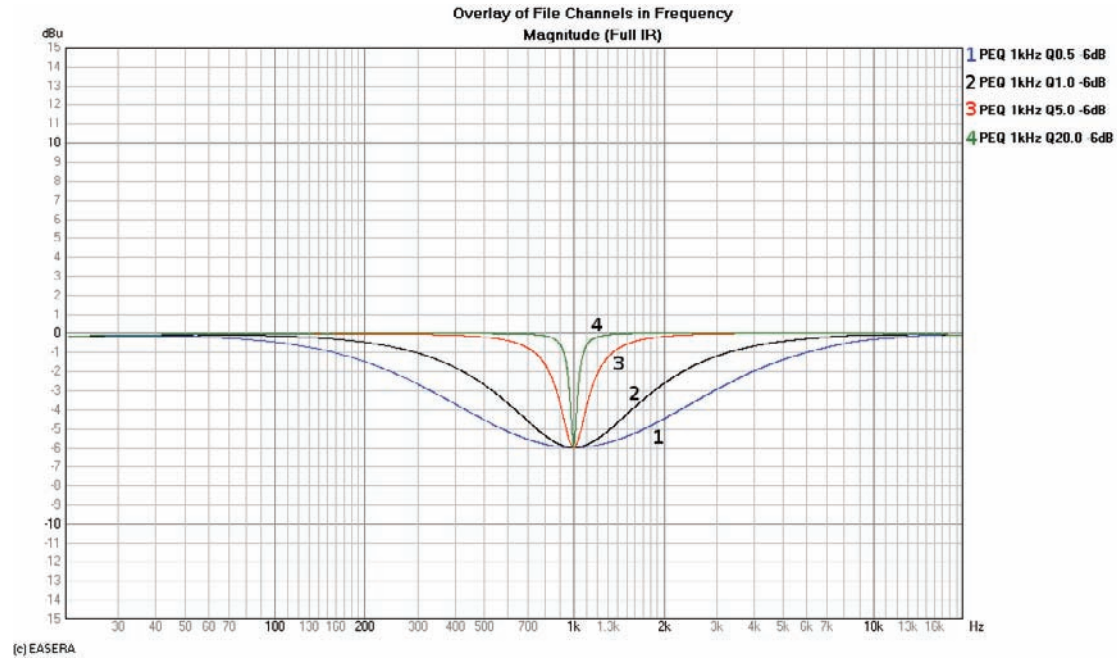

10.2 6 dB-Oct Shelves at 200 Hz and 2 kHz

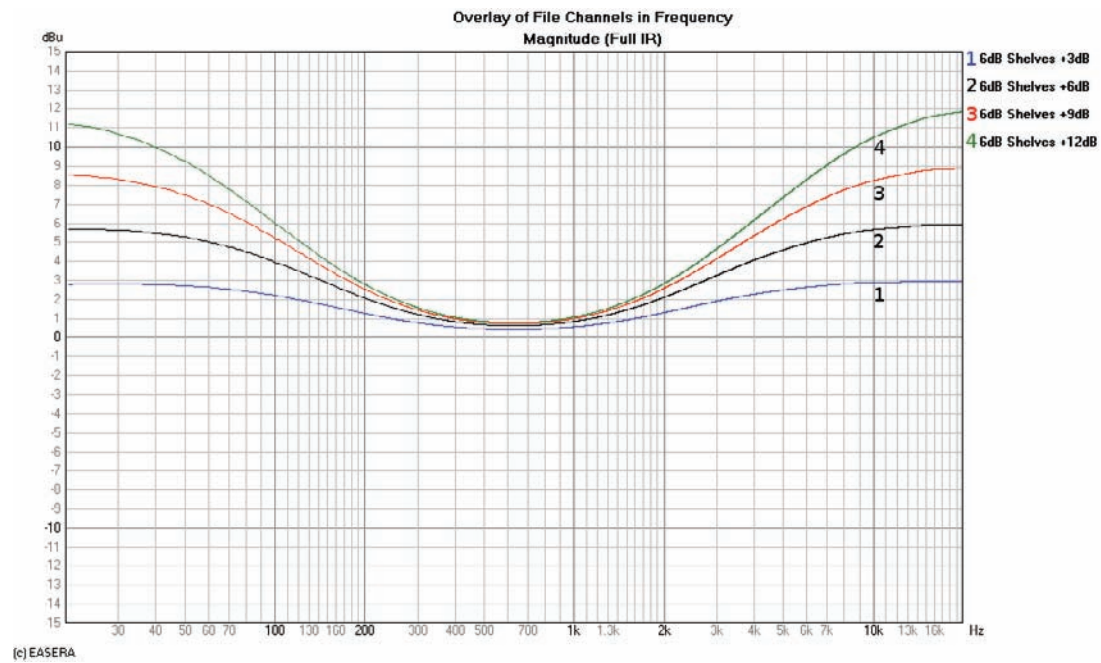

10.3 12 dB PEQ Cuts Q Changes

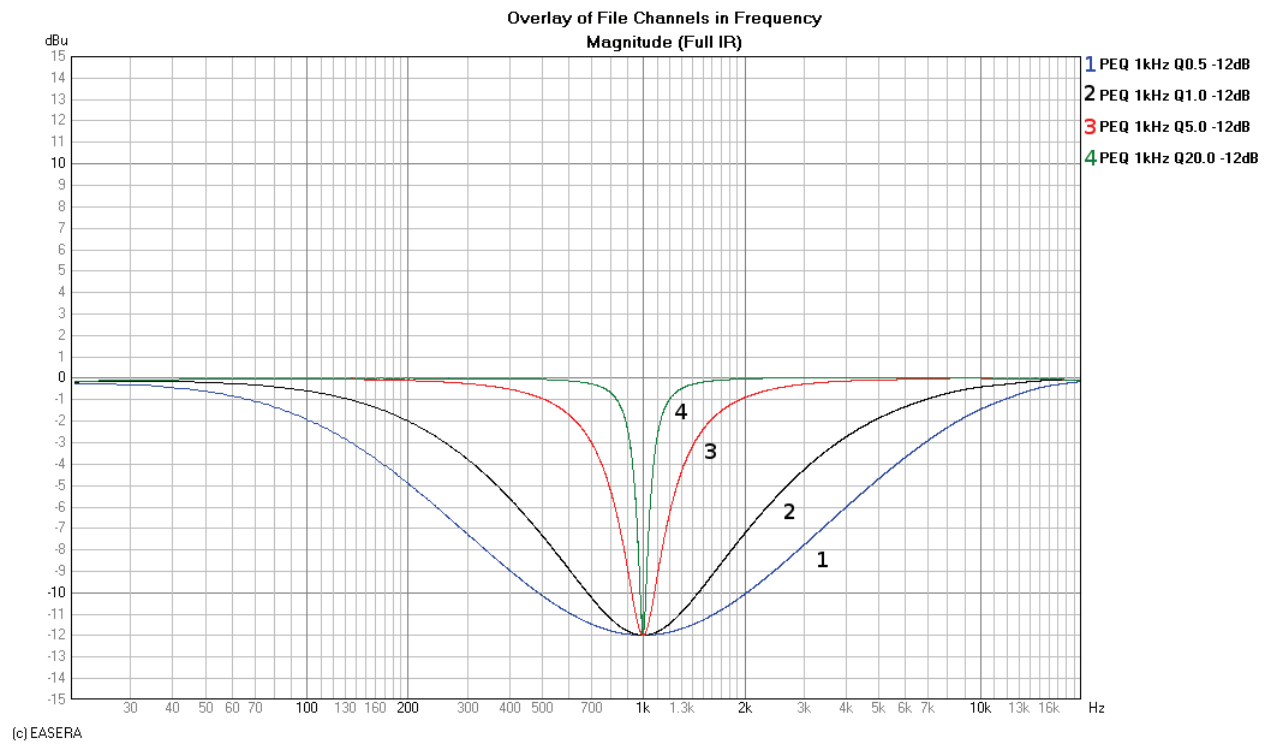

10.4 12dB-Oct Shelves at 200 Hz and 2 kHz

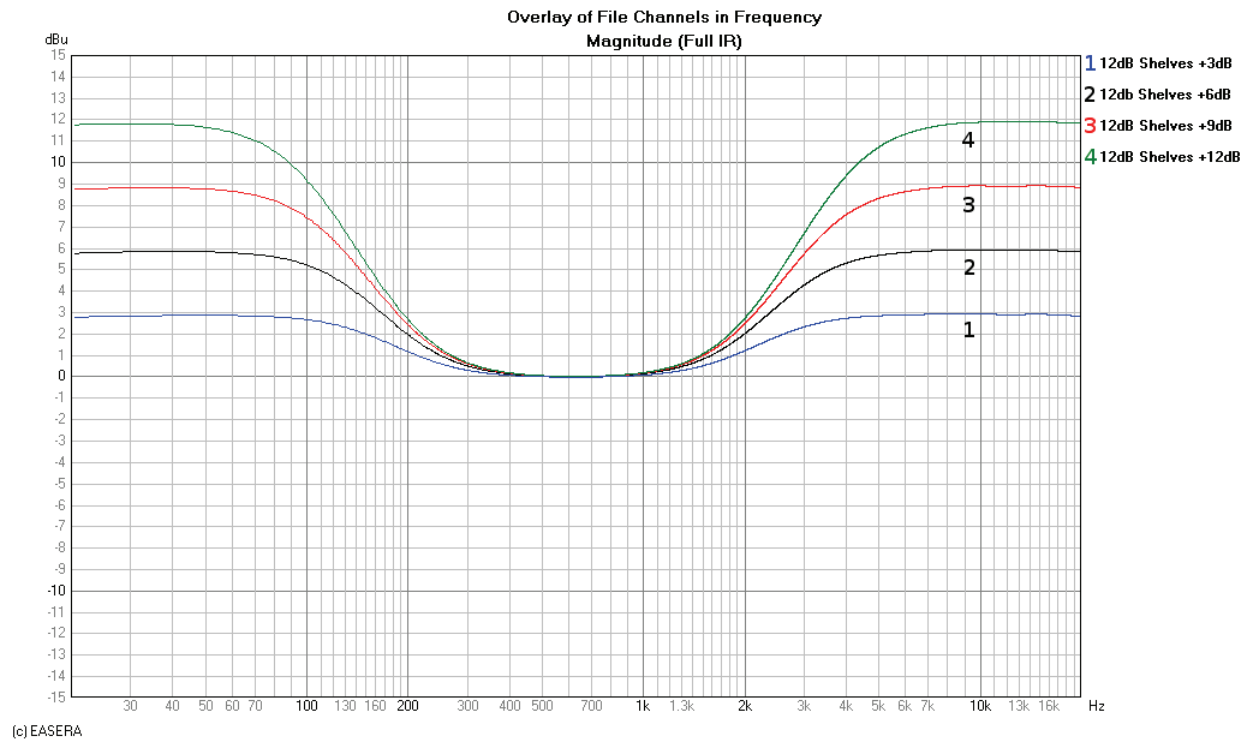

10.7 Hi Lo Pass Filters

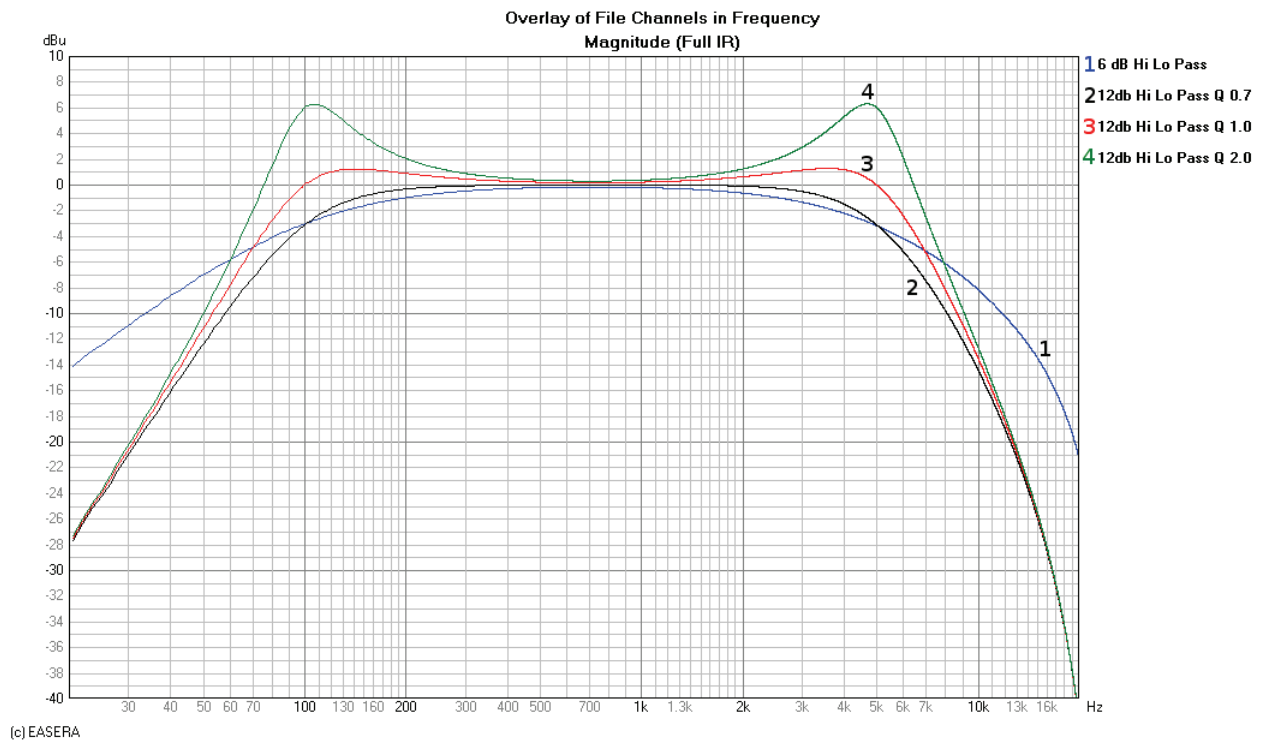

10.8 Linkwitz-Riley Filters

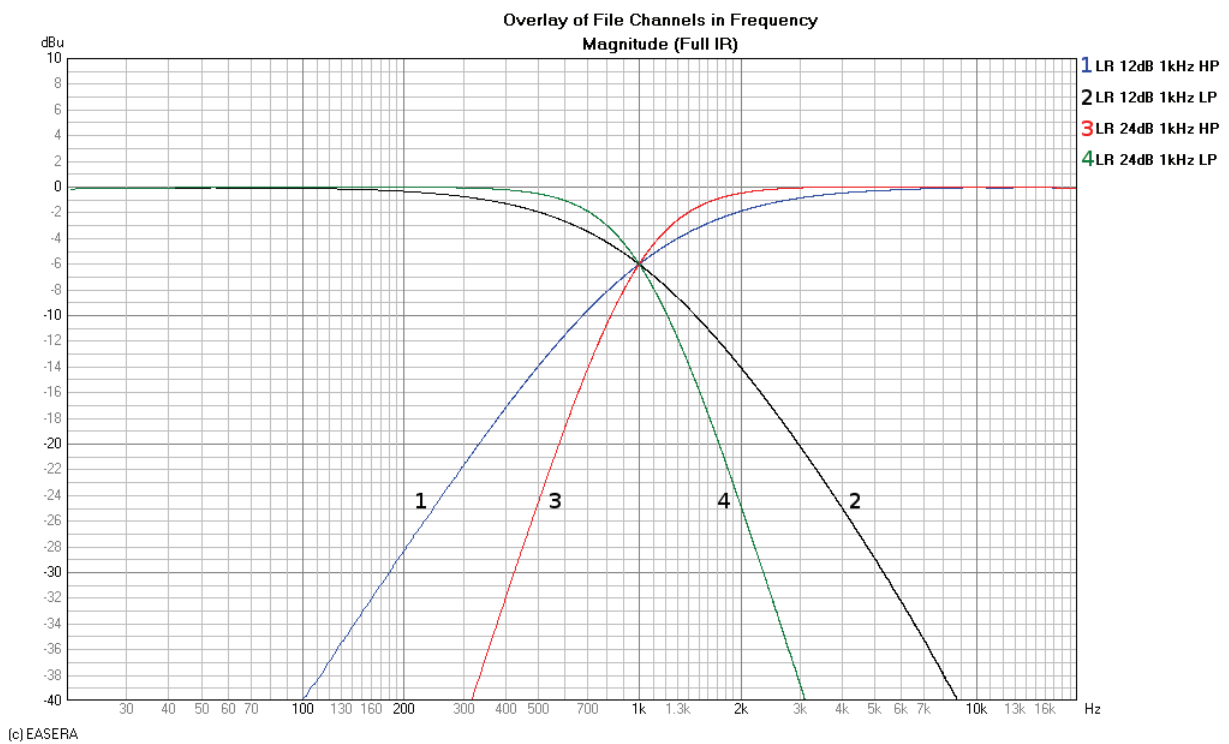

10.9 PEQ Gains

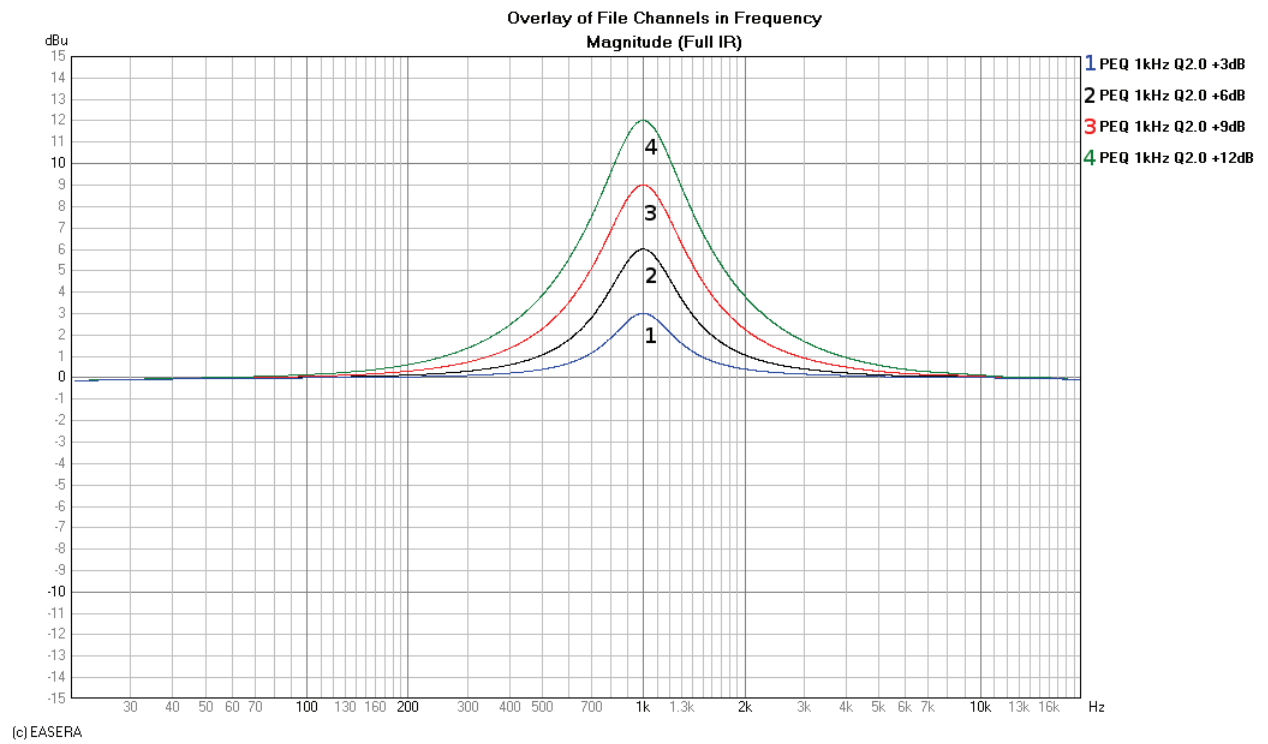

Notes

Notes

Americas

Bosch Communications Systems
12000 Portland Ave South
Burnsville, MN 55337, USA
USA:

Phone: 1-800-392-3497

Fax: 1-800-955-6831

Canada:

Phone: 1-866-505-5551

Fax: 1-866-336-8467

Latin America:

Phone: 1-952-887-5532

Fax: 1-952-736-4212

Europe, Africa & Middle-East

Germany:

Bosch Communications Systems
EVI Audio GmbH
Hirschberger Ring 45
D-94315 Straubing, Germany
Phone: +49 9421 706-0
Fax: +49 9421 706-265

France:

EVI Audio France S.A.
Parc de Courcerin
Allée Lech Walesa
F 77185 Lognes, France
Phone: +33 1-6480-0090
Fax: +33 1-6006-5103

Asia & Pacific Rim

Japan:

EVI Audio Japan Ltd.
5-3-8 Funabashi, Setagaya-Ku
Tokyo, Japan 156-0055
Phone: +81 3-5316-5020
Fax: +81 3-5316-5031

China:

Bosch Communications Systems
Telex EVI Audio (Shanghai) Co., Ltd.
Room 3105-3109, No. 1 Building
No. 218, Tian Mu West Road
Shanghai, China
Postal Code: 200070
Phone: +86 21-6317-2155
Fax: +86 21-6317-3023

Hong Kong:

Telex EVI Audio (HK) Ltd.
Unit 5, 1/F, Topsail Plaza
11 On Shum Street
Shek Mun, Shatin HK
Phone: +852 2351-3628
Fax: +852 2351-3329

Singapore:

Telex Pte. Ltd.
38C Jalan Pemimpin
Singapore 577180
Phone: +65 6319-0621
Fax: +65 6319-0620