

## PA Amplifiers

# iNUKE NU12000DSP/NU6000DSP/ NU3000DSP/NU1000DSP/NU12000/ NU6000/NU3000/NU1000



### NU12000DSP

#### Ultra-Lightweight, High-Density 12000-Watt Power Amplifier with DSP Control and USB Interface

- Delivers 2 x 6000 Watts into 4 Ohms,  
2 x 3000 Watts into 8 Ohms and  
weighs less than 18 lbs / 8.2 kg

### iNUKE NU6000DSP—

#### Ultra-Lightweight, High-Density 6000-Watt Power Amplifier with DSP Control and USB Interface

- Delivers 2 x 3000 Watts into 4 Ohms,  
2 x 1500 Watts into 8 Ohms and  
weighs less than 12 lbs / 5.5 kg

### iNUKE NU3000DSP—

#### Ultra-Lightweight, High-Density 3000-Watt Power Amplifier with DSP Control and USB Interface

- Delivers 2 x 1500 Watts into 2 Ohms;  
2 x 880 Watts into 4 Ohms;  
3000 Watts into 4 Ohms  
(bridge mode) and weighs less  
than 8 lbs / 3.5 kg

### iNUKE NU1000DSP —

#### Ultra-Lightweight, High-Density 1000-Watt Power Amplifier with DSP Control and USB Interface

- Delivers 2 x 500 Watts into 2 Ohms;  
2 x 300 Watts into 4 Ohms;  
1000 Watts into 4 Ohms  
(bridge mode) and weighs less  
than 8 lbs / 3.5 kg

### Common features

- Ultimate reliability through  
revolutionary cool-running  
High-Density Class-D technology  
with “near-zero” thermal buildup
- Ultra-efficient switch-mode power  
supply for noise-free audio,  
superior transient response and  
low power consumption

Our light-as-a-feather iNUKE power amps have been wildly successful, and we’ve sold truckloads of them all over the world! Why? Because they are ultra-dependable, put out massive amounts of power, yet weigh so very little thanks to our revolutionary high-density Class-D technology and ultra-efficient switch-mode power supplies. But we think we may have outdone ourselves with the new iNUKE NU12000, which packs a whopping 12,000-Watt total output! Yes, that’s right—a stereo power amplifier with 6,000 Watts per channel @ 4 Ohms, or 2 x 3,000 Watts @ 8 Ohms—and it weighs less than 18 lbs. / 8.2 kg. This groundbreaking amplifier is also available in a USB-addressable DSP version, the iNUKE NU12000DSP.

### Superb transient response

We spent years fine-tuning the high-density Class-D technology that gives the iNUKE Series its oomph. By carefully selecting transistors with extremely high slew rates and optimizing

other proprietary parts of our circuitry, these amps react instantly to even the most demanding bass impulses.

When this amazing amplifier technology is combined with our state-of-the-art switching-mode power supplies, these amplifiers provide tremendous punch. And because they are so much more efficient than conventional designs, they run cooler and don’t require the massive heat sinks and heavy toroid transformers typically associated with their conventional counterparts.

### Sublimely simple operation

The front panel controls and indicators provide your system’s vital signs at a glance. After pressing the Power button, the Power LED lights to show the amp is ready for action. All channels feature positive-detent Gain controls with Signal LEDs that light when a signal is present, as well as clip LEDs to indicate when the signal is distorted and you need to reduce the input signal.

*Continued on next page*



# iNUKE NU12000DSP/ NU6000DSP/ NU3000DSP/ NU1000DSP/ NU12000/ NU6000/ NU3000/ NU1000

- High-performance DSP and 24-bit/96 kHz converters deliver ultimate signal integrity and extreme dynamic range
- DSP section features sophisticated delay, crossover (3 filter types, up to 48 dB/octave), EQ (8 parametric, 2 dynamic), dynamics processing and lockable security settings
- Front panel LCD display enables setup and adjustment without PC
- Can be set up, controlled and monitored via front panel USB connector. Powerful remote software downloadable at [behringer.com](http://behringer.com)
- "Zero-Attack" limiters offer maximum output level with reliable overload protection
- Built-in Subwoofer/Satellite crossover for perfect subwoofer operation
- Detented and illuminated gain controls for precise level setting
- Precise 4-segment Signal and Limit LEDs to monitor performance
- XLR and ¼" TRS combination input connectors for compatibility with any source
- Professional twist-lock speaker connectors for ultimate reliability
- Independent DC, LF and thermal overload protection on each channel automatically protects amplifier and speakers without shutting down the show
- "Back-to-front" ventilation system prevents thermal buildup for reliable operation
- High-quality components and exceptionally rugged construction ensure long life
- Conceived and designed by BEHRINGER Germany

The rear panel is just as elegant, with combo XLR and ¼" TRS input connectors making the iNUKE compatible with virtually any source, balanced or unbalanced. Professional twist-lock speaker sockets are provided to ensure every drop of output power gets to your loudspeakers. The rear panel is also where you'll find the switches that enable iNUKE amps to work in either dual mono, stereo or mono bridge mode. A built-in CROSSOVER switch enables the amp to operate in biamp mode, sending low frequency content to passive subwoofers, while the high frequency output is channeled to fullrange loudspeakers (CH1>100 Hz / CH2<100 Hz or FULLRANGE).

## iNUKE DSP

For sound engineers requiring high-level control capability, iNUKE DSP Series amplifiers come ready for action right out-of-the-box. The built-in DSP and 24-bit/96 kHz converters ensure the ultimate signal integrity with an extremely broad dynamic range. DSP functions include a sophisticated delay for delay-line loudspeakers, crossover, EQ (eight parametric, two dynamic), and dynamics processing with lockable security settings. A convenient front panel LCD display allows you to setup and make adjustments directly at the amplifier, without the need for a PC. All iNUKE DSP models can be set up, controlled and monitored via the front panel USB connector.

*Continued on next page*

## iNUKE NU6000/NU3000/NU1000

### Front Panel

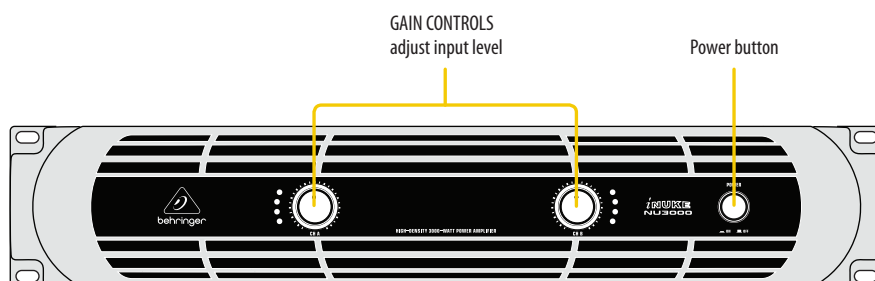

### Rear Panel

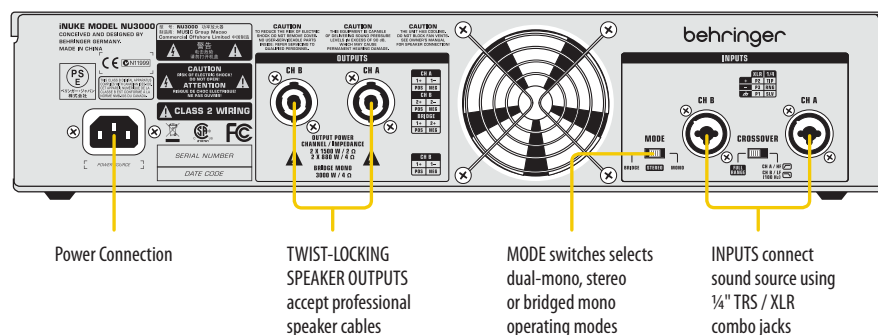

# iNUKE NU12000DSP/ NU6000DSP/ NU3000DSP/ NU1000DSP/ NU12000/ NU6000/ NU3000/ NU1000

## iNUKE NU12000

### Ultra-Lightweight, High-Density 12000-Watt Power Amplifier

- Delivers 2 x 6000 Watts into 4 Ohms,  
2 x 3000 Watts into 8 Ohms and  
weighs less than 18 lbs / 8.2 kg

## iNUKE NU6000—

### Ultra-Lightweight, High-Density 6000-Watt Power Amplifier

- Delivers 2 x 3000 Watts into 4 Ohms,  
2 x 1500 Watts into 8 Ohms and  
weighs less than 12 lbs / 5.5 kg

## iNUKE NU3000—

### Ultra-Lightweight, High-Density 3000-Watt Power Amplifier

- Delivers 2 x 1500 Watts into 2 Ohms;  
2 x 880 Watts into 4 Ohms;  
3000 Watts into 4 Ohms  
(bridge mode) and weighs less than  
7 lbs / 3.3 kg

## iNUKE NU1000—

### Ultra-Lightweight, High-Density 1000-Watt Power Amplifier

- Delivers 2 x 500 Watts into 2 Ohms;  
2 x 300 Watts into 4 Ohms;  
1000 Watts into 4 Ohms  
(bridge mode) and weighs less than  
7 lbs / 3.3 kg

## Common features

- Ultimate reliability through revolutionary cool-running High-Density Class-D technology with “near-zero” thermal build up
- Ultra-efficient switch-mode power supply for noise-free audio, superior transient response and low power consumption
- “Zero-Attack” limiters offer maximum output level with reliable overload protection

## Value

Sporting massive output ratings, lightweight Class-D technology, an equally lightweight price tag, and

all the amenities a professional audio engineer could ask for, BEHRINGER iNUKE amplifiers are serious amps for the most demanding applications.

## iNUKE NU6000DSP/NU3000DSP/NU1000DSP

### Front Panel

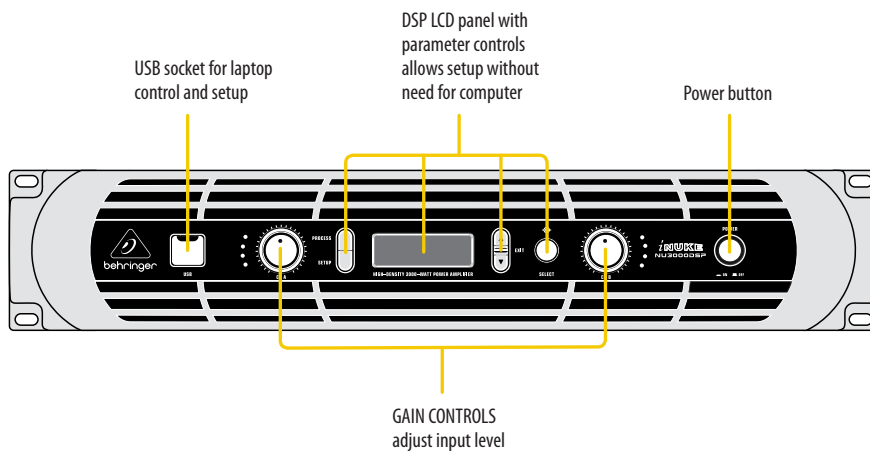

### Rear Panel

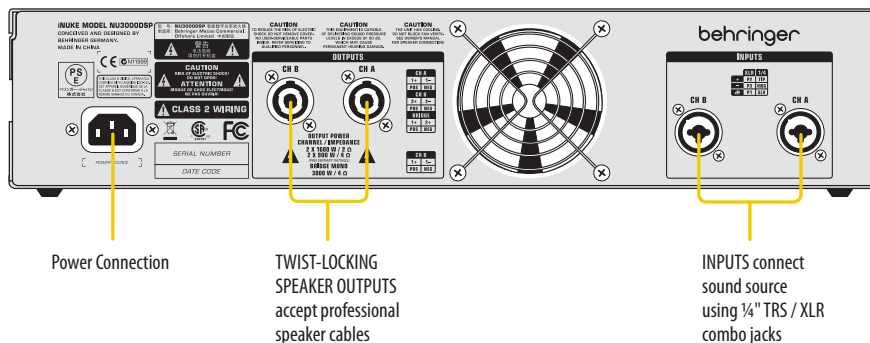



# iNUKE NU12000DSP/ NU6000DSP/ NU3000DSP/ NU1000DSP/ NU12000/ NU6000/ NU3000/ NU1000

- Built-in Subwoofer/Satellite crossover for perfect subwoofer operation
- Detented and illuminated gain controls for precise level setting
- Precise 4-segment Signal and Limit LEDs to monitor performance
- XLR and ¼" TRS combination input connectors for compatibility with any source
- Professional twist-lock speaker connectors for ultimate reliability
- Independent DC, LF and thermal overload protection on each channel automatically protects amplifier and speakers without shutting down the show
- "Back-to-front" ventilation system prevents thermal buildup for reliable operation
- High-quality components and exceptionally rugged construction ensure long life
- Conceived and designed by BEHRINGER Germany



System configuration is a breeze thanks to iNUKE's Amp Remote software (Available on iNUKE DSP models only)



Dynamic EQ combines the effects of equalization and side-chain compression to compensate for the perceived loudness of specific frequency ranges (Available on iNUKE DSP models only)



iNUKE's DSP crossover features 3 filter types (at up to 48 dB/octave) for the ultimate in versatility (Available on iNUKE DSP models only)



8 Parametric EQ filters make it easy to optimize system performance with just a few mouse clicks (Available on iNUKE DSP models only)



Save and recall frequently-used setups, complete with lockout codes for total system security (Available on iNUKE DSP models only)

**iNUKE NU12000DSP/  
NU6000DSP/  
NU3000DSP/  
NU1000DSP/  
NU12000/  
NU6000/  
NU3000/  
NU1000**

## iNUKE NU3000 – Live Setup with PA and Floor Monitor

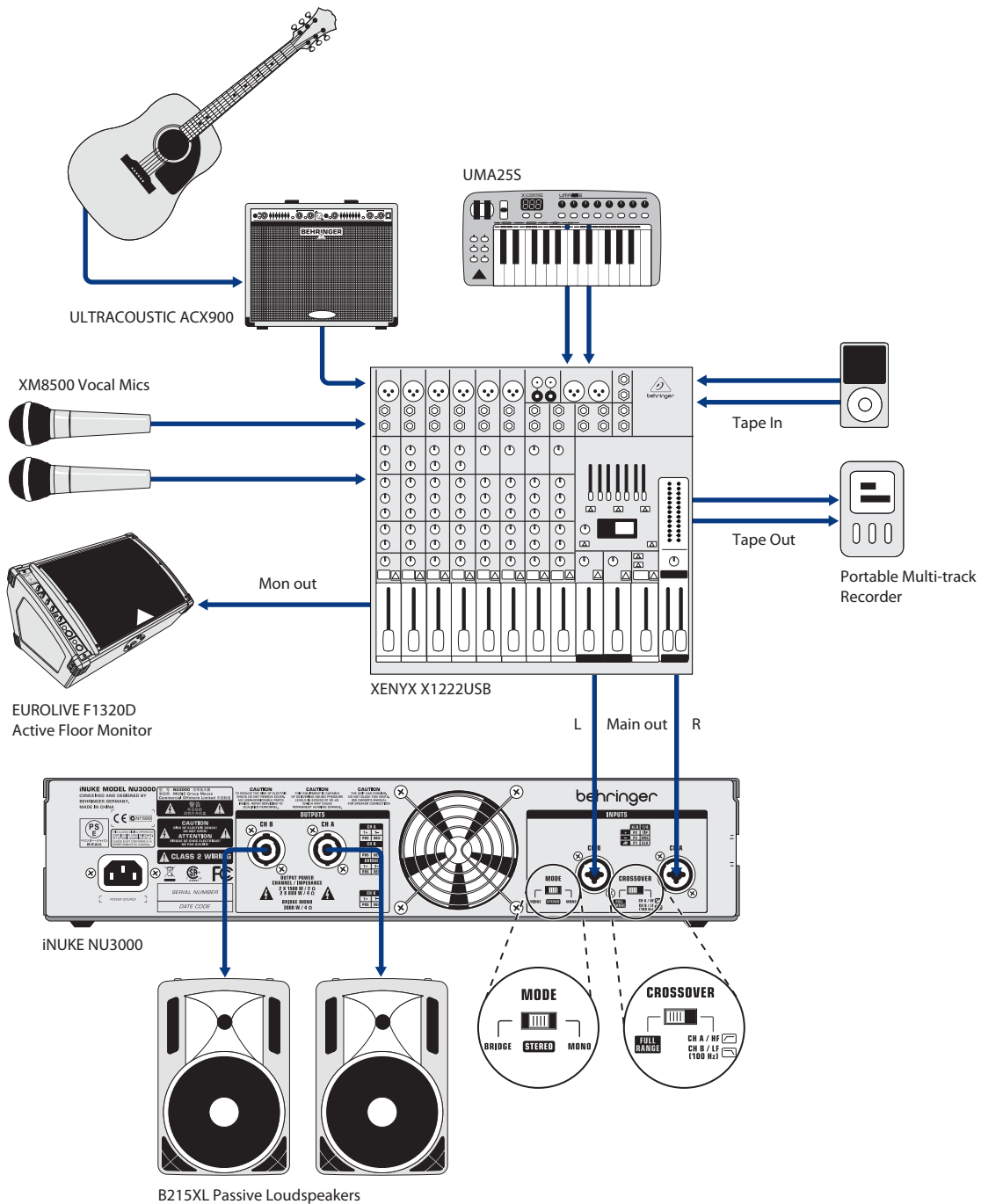

**iNUKE NU12000DSP/  
NU6000DSP/  
NU3000DSP/  
NU1000DSP/  
NU12000/  
NU6000/  
NU3000/  
NU1000**

### Concert Setup with Delay Line

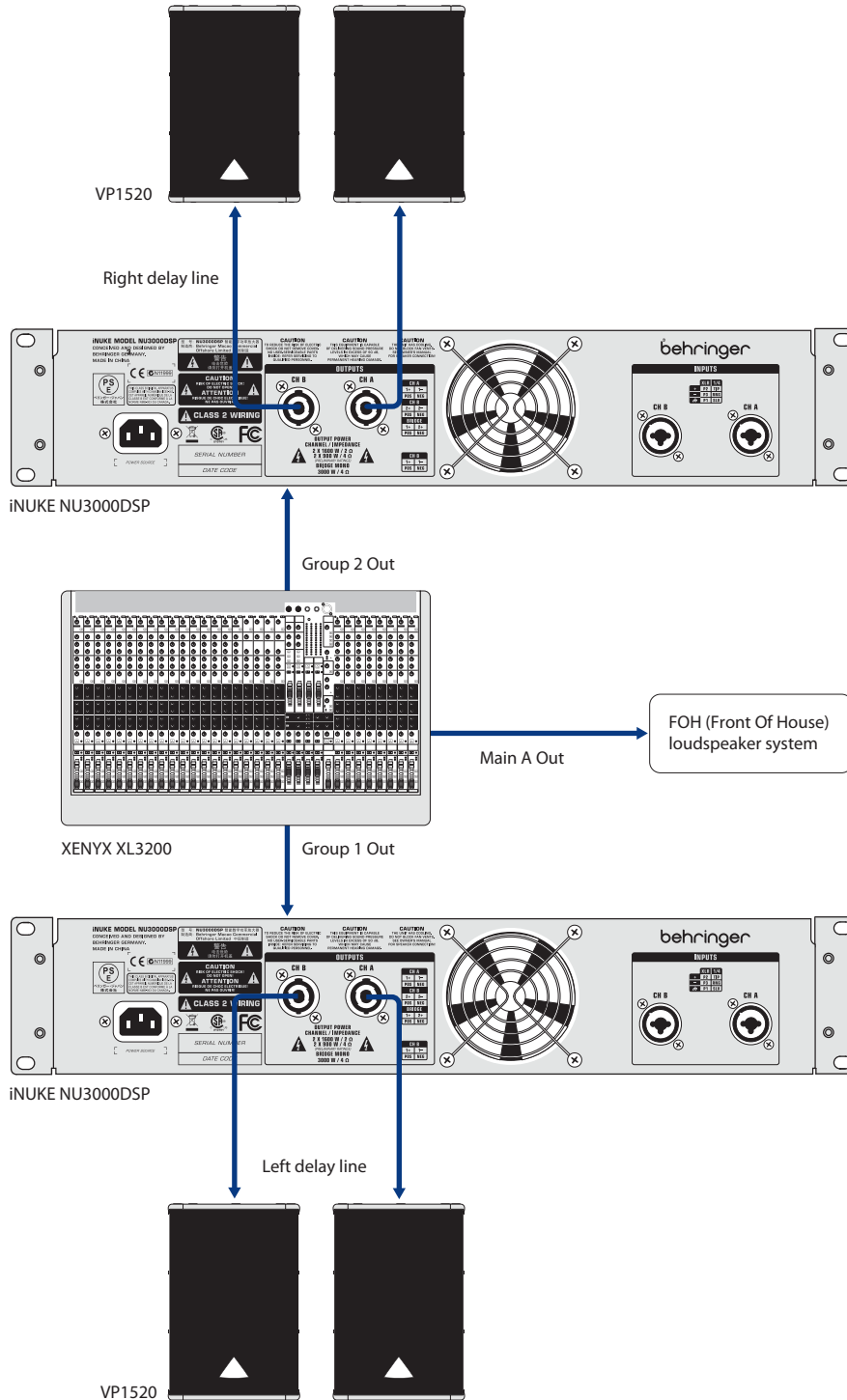

**iNUKE NU12000DSP/  
NU6000DSP/  
NU3000DSP/  
NU1000DSP/  
NU12000/  
NU6000/  
NU3000/  
NU1000**

### iNUKE NU1000 – Live Stereo DJ Setup with Passive PA

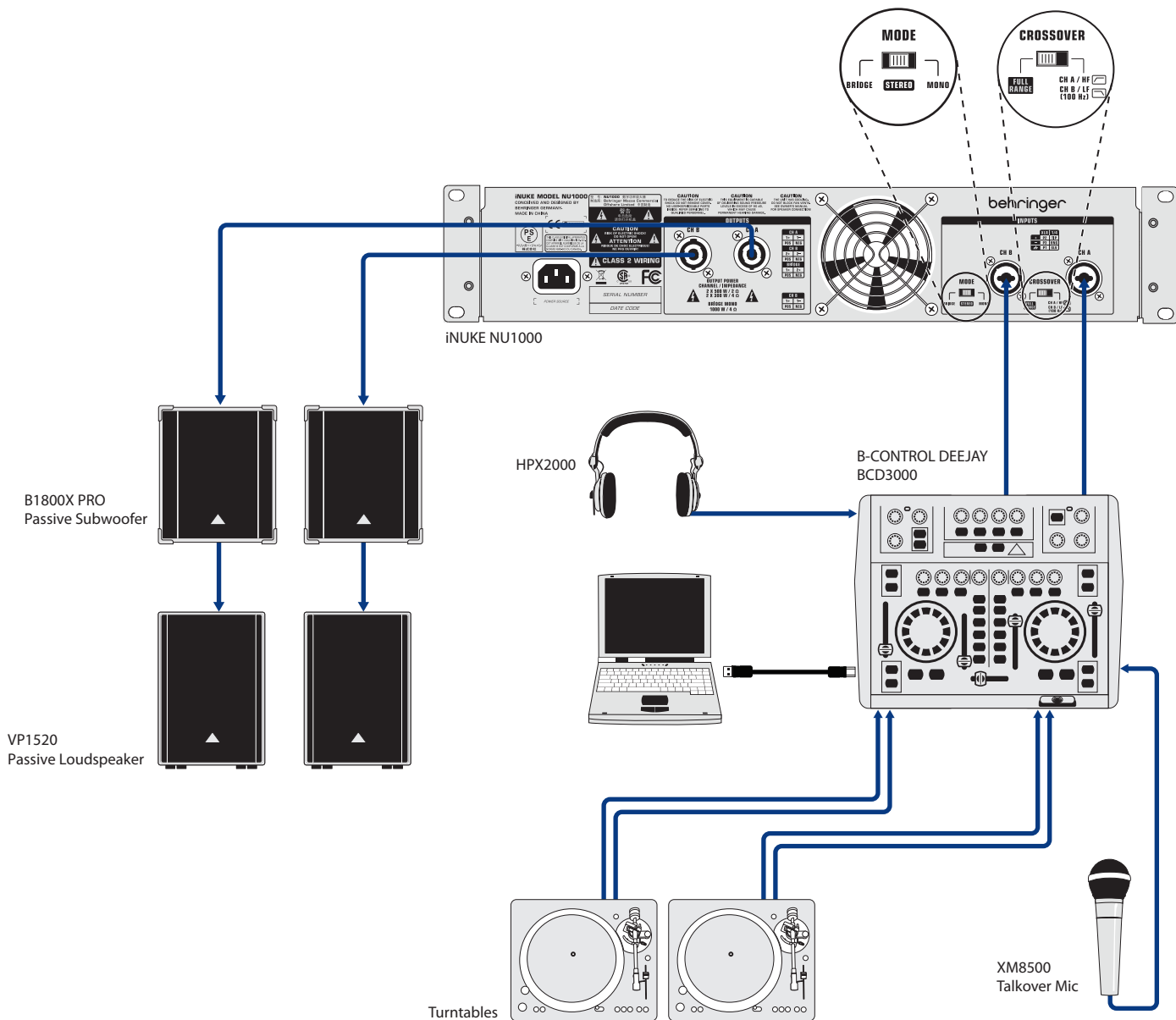

# iNUKE NU12000DSP/ NU6000DSP/ NU3000DSP/ NU1000DSP/ NU12000/ NU6000/ NU3000/ NU1000

## Specifications

### NU6000DSP

#### Output Power

##### Maximum output power

|                         |        |
|-------------------------|--------|
| Stereo                  |        |
| 8 Ω per channel, stereo | 1500 W |
| 4 Ω per channel, stereo | 3000 W |
| 2 Ω per channel, stereo | —      |

##### Bridged mono

|     |   |
|-----|---|
| 8 Ω | — |
| 4 Ω | — |

#### RMS

|                         |        |
|-------------------------|--------|
| Stereo                  |        |
| 8 Ω per channel, stereo | 1100 W |
| 4 Ω per channel, stereo | 2200 W |
| 2 Ω per channel, stereo | —      |

##### Bridged mono

|     |   |
|-----|---|
| 8 Ω | — |
| 4 Ω | — |

#### System

##### Controls

|       |   |
|-------|---|
| Front | Power switch, Gain controls (channels A and B) DSP section rotary push-encoder, Buttons for Process, Setup, Up/Down, Exit |
|-------|---|

##### Indicators

|                      |   |
|----------------------|---|
| Power                | Amber backlit illuminated gain controls |
| Limit (per channel)  | 0 dB, full scale                        |
| Signal (per channel) | -24, -12, -6 dB                         |

##### Digital Signal Processing (DSP)

|   |   |
|---|---|
| Display                                 | LCD 128 x 32, amber backlit                 |
| Digital delay function (per channel)    | 0 - 300 ms                                  |
| Digital crossover function              | 3 filter types, up to 48 dB/octave          |
| Digital EQ function (per channel)       | 8-band parametric, 2-band dynamic equalizer |
| Digital dynamics function (per channel) | Zero attack limiter (peak)                  |
| Presets                                 | 20 total presets, 19 user-definable         |

#### Connectors

|                     |  |
|---------------------|--|
| Inputs              | 2 x combo jacks  |
| Input impedance     | 10 kΩ unbalanced, 20 kΩ balanced                                   |
| Outputs             | 2 x locking-style professional speaker connectors                  |
| Output circuit type | Class D  |
| Distortion          | <0.2%  |
| Frequency response  | 20 Hz to 20 kHz, +0 / -2 dB  |
| Damping factor      | >140 @ 8 Ω   |
| Signal-to-noise     | >98 dB   |
| USB                 | Front panel USB connector type B for remote control of DSP section |

#### Circuit Protection

|                      |   |
|----------------------|---|
| Cooling              | Continuously variable speed fan, Back-to-front air flow             |
| Amplifier protection | Thermal and DC protection, Stable into reactive or mismatched loads |
| Load protection      | On/off muting, DC-fault power supply shutdown                       |

#### Power Supply, Power Consumption @ 1/8 Rated Power, Voltage (Breaker / Fuses)

|                            |                             |
|----------------------------|-----------------------------|
| USA / Canada               | 120V~, 60Hz (25A)           |
| UK / Australia / Europe    | 220-240 V~, 50/60 Hz, (12A) |
| Korea / China              | 220-240 V~, 50/60 Hz, (12A) |
| Japan                      | 100 V~, 50/60 Hz, (25A)     |
| Power consumption @ 2 ohms | —                           |
| Power consumption @ 4 ohms | 620 W                       |
| Mains connector            | Standard IEC receptacle     |

#### Dimensions/Weight

|                        |   |
|------------------------|---|
| Dimensions (H x W x D) | appr. 3.5 x 19.01 x 12.91"<br>appr. 89 x 483 x 328 mm |
| Weight                 | appr. 11.4 lbs / 5.2 kg                               |

### NU3000DSP

#### Output Power

##### Maximum output power

|                         |        |
|-------------------------|--------|
| Stereo                  |        |
| 8 Ω per channel, stereo | 440 W  |
| 4 Ω per channel, stereo | 820 W  |
| 2 Ω per channel, stereo | 1520 W |

##### Bridged mono

|     |        |
|-----|--------|
| 8 Ω | 1500 W |
| 4 Ω | 3000 W |

#### RMS

|                         |        |
|-------------------------|--------|
| Stereo                  |        |
| 8 Ω per channel, stereo | 315 W  |
| 4 Ω per channel, stereo | 620 W  |
| 2 Ω per channel, stereo | 1040 W |

##### Bridged mono

|     |        |
|-----|--------|
| 8 Ω | 1250 W |
| 4 Ω | 2075 W |

#### System

##### Controls

|       |   |
|-------|---|
| Front | Power switch, Gain controls (channels A and B) DSP section rotary push-encoder, Buttons for Process, Setup, Up/Down, Exit |
|-------|---|

##### Indicators

|                      |   |
|----------------------|---|
| Power                | Amber backlit illuminated gain controls |
| Limit (per channel)  | 0 dB, full scale                        |
| Signal (per channel) | -24, -12, -6 dB                         |

##### Digital Signal Processing (DSP)

|   |   |
|---|---|
| Display                                 | LCD 128 x 32, amber backlit                 |
| Digital delay function (per channel)    | 0 - 300 ms                                  |
| Digital crossover function              | 3 filter types, up to 48 dB/octave          |
| Digital EQ function (per channel)       | 8-band parametric, 2-band dynamic equalizer |
| Digital dynamics function (per channel) | Zero attack limiter (peak)                  |
| Presets                                 | 20 total presets, 19 user-definable         |



# iNUKE NU12000DSP/ NU6000DSP/ NU3000DSP/ NU1000DSP/ NU12000/ NU6000/ NU3000/ NU1000

## Connectors

|                     |  |
|---------------------|--|
| Inputs              | 2 x combo jacks  |
| Input impedance     | 10 k $\Omega$ unbalanced,<br>20 k $\Omega$ balanced                      |
| Outputs             | 2 x locking-style professional<br>speaker connectors                     |
| Output circuit type | Class D  |
| Distortion          | <0.3%  |
| Frequency response  | 20 Hz to 20 kHz, +0 / -1 dB  |
| Damping factor      | >145 @ 8 $\Omega$  |
| Signal-to-noise     | >98 dB   |
| USB                 | Front panel USB connector<br>type B for remote<br>control of DSP section |

## Circuit Protection

|                      |   |
|----------------------|---|
| Cooling              | Continuously variable<br>speed fan, Back-to-front<br>air flow             |
| Amplifier protection | Thermal and DC protection,<br>Stable into reactive or<br>mismatched loads |
| Load protection      | On/off muting,<br>DC-fault power supply<br>shutdown                       |

## Power Supply, Power Consumption @ 1/8 Rated Power, Voltage (Breaker / Fuses)

|                            |   |
|----------------------------|---|
| USA / Canada               | 120 V~, 60 Hz (T 10 A H 250 V)            |
| UK / Australia / Europe    | 220-240 V~, 50/60 Hz<br>(T 6.3 A H 250 V) |
| Korea / China              | 220-240 V~, 50/60 Hz<br>(T 6.3 A H 250 V) |
| Japan                      | 100 V~, 50/60 Hz<br>(T 10 A H 250 V)      |
| Power consumption @ 2 ohms | 350 W                                     |
| Power consumption @ 4 ohms | 210 W                                     |
| Mains connector            | Standard IEC receptacle                   |

## Dimensions/Weight

|                        |   |
|------------------------|---|
| Dimensions (H x W x D) | appr. 3.5 x 19 x 9.76"<br>appr. 89 x 483 x 248 mm |
| Weight                 | appr. 6.8 lbs / 3.1 kg                            |

## NU1000DSP

### Output Power

#### Maximum Output Power

|                                |        |
|--------------------------------|--------|
| Stereo                         |        |
| 8 $\Omega$ per channel, stereo | 160 W  |
| 4 $\Omega$ per channel, stereo | 320 W  |
| 2 $\Omega$ per channel, stereo | 530 W  |
| Bridged mono                   |        |
| 8 $\Omega$                     | 570 W  |
| 4 $\Omega$                     | 1050 W |
| RMS                            |        |
| Stereo                         |        |
| 8 $\Omega$ per channel, stereo | 110 W  |
| 4 $\Omega$ per channel, stereo | 210 W  |
| 2 $\Omega$ per channel, stereo | 380 W  |
| Bridged mono                   |        |
| 8 $\Omega$                     | 430 W  |
| 4 $\Omega$                     | 750 W  |

### System

#### Controls

|       |  |
|-------|--|
| Front | Front Power switch,<br>Gain controls (channels<br>A and B) DSP section<br>rotary push-encoder,<br>Buttons for Process,<br>Setup, Up/Down, Exit |
|-------|--|

#### Indicators

|                      |  |
|----------------------|--|
| Power                | Amber backlit illuminated<br>gain controls |
| Limit (per channel)  | 0 dB, full scale                           |
| Signal (per channel) | -24, -12, -6 dB                            |

#### Digital Signal Processing (DSP)

|  |  |
|--|--|
| Display                                    | LCD 128 x 32, amber backlit                    |
| Digital delay function<br>(per channel)    | 0 - 300 ms                                     |
| Digital crossover function                 | 3 filter types,<br>up to 48 dB/octave          |
| Digital EQ function<br>(per channel)       | 8-band parametric,<br>2-band dynamic equalizer |
| Digital dynamics function<br>(per channel) | Zero attack limiter (peak)                     |
| Presets                                    | 20 total presets,<br>19 user-definable         |

## Connectors

|                     |  |
|---------------------|--|
| Inputs              | 2 x combo jacks  |
| Input impedance     | 10 k $\Omega$ unbalanced,<br>20 k $\Omega$ balanced                      |
| Outputs             | 2 x locking-style professional<br>speaker connectors                     |
| Output circuit type | Class D  |
| Distortion          | <0.1%  |
| Frequency response  | 20 Hz to 20 kHz, +0 / -1 dB  |
| Damping factor      | >155 @ 8 $\Omega$  |
| Signal-to-noise     | >98 dB   |
| USB                 | Front panel USB connector<br>type B for remote<br>control of DSP section |

## Circuit Protection

|                      |   |
|----------------------|---|
| Cooling              | Continuously variable<br>speed fan, Back-to-front<br>air flow             |
| Amplifier protection | Thermal and DC protection,<br>Stable into reactive or<br>mismatched loads |
| Load protection      | On/off muting,<br>DC-fault power supply<br>shutdown                       |

## Power Supply, Power Consumption @ 1/8 Rated Power, Voltage (Breaker / Fuses)

|                            |  |
|----------------------------|--|
| USA / Canada               | 120 V~, 60 Hz (T 6.3 A H 250 V)            |
| UK / Australia / Europe    | 220-240 V~, 50/60 Hz<br>(T 3.15 A H 250 V) |
| Korea / China              | 220-240 V~, 50/60 Hz<br>(T 3.15 A H 250 V) |
| Japan                      | 100 V~, 50/60 Hz<br>(T 6.3 A H 250 V)      |
| Power consumption @ 2 ohms | 150 W                                      |
| Power consumption @ 4 ohms | 70 W                                       |
| Mains connector            | Standard IEC receptacle                    |

## Dimensions/Weight

|                        |   |
|------------------------|---|
| Dimensions (H x W x D) | appr. 3.5 x 19 x 9.76"<br>appr. 89 x 483 x 248 mm |
| Weight                 | appr. 6.8 lbs / 3.1 kg                            |

# iNUKE NU12000DSP/ NU6000DSP/ NU3000DSP/ NU1000DSP/ NU12000/ NU6000/ NU3000/ NU1000

## NU6000

### Output Power

#### Maximum Output Power

| Stereo                  |        |
|-------------------------|--------|
| 8 Ω per channel, stereo | 1500 W |
| 4 Ω per channel, stereo | 3000 W |
| 2 Ω per channel, stereo | —      |
| Bridged mono            |        |
| 8 Ω                     | —      |
| 4 Ω                     | —      |
| RMS                     |        |
| Stereo                  |        |
| 8 Ω per channel, stereo | 1100 W |
| 4 Ω per channel, stereo | 2200 W |
| 2 Ω per channel, stereo | —      |
| Bridged mono            |        |
| 8 Ω                     | —      |
| 4 Ω                     | —      |

### System

#### Controls

|       |   |
|-------|---|
| Front | Power switch<br>Gain controls (channels A and B)                    |
| Rear  | Mode switch (stereo/mono)<br>Crossover switch<br>(fullrange/100 Hz) |

#### Indicators

|                      |   |
|----------------------|---|
| Power                | Amber/red backlit illuminated gain controls |
| Limit (per channel)  | 0 dB, full scale                            |
| Signal (per channel) | -24, -12, -6 dB                             |

#### Connectors

|                     |   |
|---------------------|---|
| Inputs              | 2 x combo jacks                                   |
| Input impedance     | 10 kΩ unbalanced,<br>20 kΩ balanced               |
| Outputs             | 2 x locking-style professional speaker connectors |
| Output circuit type | Class D   |
| Distortion          | <0.2%   |
| Frequency response  | 20 Hz to 20 kHz, +0 / -2 dB                       |
| Damping factor      | >140 @ 8 Ω  |
| Signal-to-noise     | >100 dB   |

#### Circuit Protection

|         |   |
|---------|---|
| Cooling | Continuously variable speed fan<br>Back-to-front air flow |
|---------|---|

|                      |   |
|----------------------|---|
| Amplifier protection | Thermal and DC protection<br>Stable into reactive or mismatched loads |
| Load protection      | On/off muting, DC-fault power supply shutdown                         |

### Power Supply, Voltage (Breaker/Fuse)

|                         |                             |
|-------------------------|-----------------------------|
| USA / Canada            | 120V~, 60Hz (25A)           |
| UK / Australia / Europe | 220-240 V~, 50/60 Hz, (12A) |
| Korea / China           | 220-240 V~, 50/60 Hz, (12A) |
| Japan                   | 100 V~, 50/60 Hz, (25A)     |
| Power consumption @ 2 Ω | —                           |
| Power consumption @ 4 Ω | 620 W                       |
| Mains connector         | Standard IEC receptacle     |

### Dimensions/Weight

|                        |  |
|------------------------|--|
| Dimensions (H x W x D) | appr. 3.5 x 19 x 12.91"<br>appr. 89 x 483 x 328 mm |
| Weight                 | 11 lbs / 5 kg                                      |

## NU3000

### Output Power

#### Maximum Output Power

| Stereo                  |        |
|-------------------------|--------|
| 8 Ω per channel, stereo | 440 W  |
| 4 Ω per channel, stereo | 880 W  |
| 2 Ω per channel, stereo | 1500 W |
| Bridged mono            |        |
| 8 Ω                     | 1500 W |
| 4 Ω                     | 3000 W |

#### RMS

| Stereo                  |        |
|-------------------------|--------|
| 8 Ω per channel, stereo | 280 W  |
| 4 Ω per channel, stereo | 550 W  |
| 2 Ω per channel, stereo | 1100 W |
| Bridged mono            |        |
| 8 Ω                     | 1100 W |
| 4 Ω                     | 2200 W |

### System

#### Controls

|       |   |
|-------|---|
| Front | Power switch<br>Gain controls (channels A and B)                              |
| Rear  | Mode switch<br>(bridge/stereo/mono)<br>Crossover switch<br>(fullrange/100 Hz) |

#### Indicators

|                      |   |
|----------------------|---|
| Power                | Amber/red backlit illuminated gain controls |
| Limit (per channel)  | 0 dB, full scale                            |
| Signal (per channel) | -24, -12, -6 dB                             |

#### Connectors

|                     |   |
|---------------------|---|
| Inputs              | 2 x combo jacks                                   |
| Input impedance     | 10 kΩ unbalanced,<br>20 kΩ balanced               |
| Outputs             | 2 x locking-style professional speaker connectors |
| Output circuit type | Class D   |
| Distortion          | <0.2%   |
| Frequency response  | 20 Hz to 20 kHz, +0 / -1 dB                       |
| Damping factor      | >160 @ 8 Ω  |
| Signal-to-noise     | >100 dB   |

#### Circuit Protection

|                      |   |
|----------------------|---|
| Cooling              | Continuously variable speed fan<br>Back-to-front air flow             |
| Amplifier protection | Thermal and DC protection<br>Stable into reactive or mismatched loads |
| Load protection      | On/off muting, DC-fault power supply shutdown                         |

### Power Supply, Voltage (Breaker/Fuse)

|                         |   |
|-------------------------|---|
| USA / Canada            | 120 V~, 60 Hz (T 10 A H 250 V)            |
| UK / Australia / Europe | 220-240 V~, 50/60 Hz<br>(T 6.3 A H 250 V) |
| Korea / China           | 220-240 V~, 50/60 Hz<br>(T 6.3 A H 250 V) |
| Japan                   | 100 V~, 50/60 Hz<br>(T 10 A H 250 V)      |
| Power consumption @ 2 Ω | 350 W                                     |
| Power consumption @ 4 Ω | 170 W                                     |
| Mains connector         | Standard IEC receptacle                   |

### Dimensions/Weight

|                        |   |
|------------------------|---|
| Dimensions (H x W x D) | appr. 3.5 x 19 x 9.76"<br>appr. 89 x 483 x 248 mm |
| Weight                 | 6.17 lbs / 2.8 kg                                 |

# iNUKE NU12000DSP/ NU6000DSP/ NU3000DSP/ NU1000DSP/ NU12000/ NU6000/ NU3000/ NU1000

## NU1000

### Output Power

#### Maximum Output Power

| Stereo                  |        |
|-------------------------|--------|
| 8 Ω per channel, stereo | 150 W  |
| 4 Ω per channel, stereo | 300 W  |
| 2 Ω per channel, stereo | 500 W  |
| Bridged mono            |        |
| 8 Ω                     | 500 W  |
| 4 Ω                     | 1000 W |
| RMS                     |        |
| Stereo                  |        |
| 8 Ω per channel, stereo | 100 W  |
| 4 Ω per channel, stereo | 200 W  |
| 2 Ω per channel, stereo | 400 W  |
| Bridged mono            |        |
| 8 Ω                     | 400 W  |
| 4 Ω                     | 800 W  |

### System

#### Controls

|       |   |
|-------|---|
| Front | Power switch<br>Gain controls (channels A and B)                              |
| Rear  | Mode switch<br>(bridge/stereo/mono)<br>Crossover switch<br>(fullrange/100 Hz) |

### Indicators

| Power                | Amber/red backlit illuminated gain controls       |
|----------------------|---|
| Limit (per channel)  | 0 dB, full scale                                  |
| Signal (per channel) | -24, -12, -6 dB                                   |
| Connectors           |   |
| Inputs               | 2 x combo jacks                                   |
| Input impedance      | 10 kΩ unbalanced,<br>20 kΩ balanced               |
| Outputs              | 2 x locking-style professional speaker connectors |
| Output circuit type  | Class D   |
| Distortion           | <0.1%   |
| Frequency response   | 20 Hz to 20 kHz, +0 / -1 dB                       |
| Damping factor       | >155 @ 8 Ω  |
| Signal-to-noise      | >100 dB   |

### Circuit Protection

|                      |   |
|----------------------|---|
| Cooling              | Continuously variable speed fan<br>Back-to-front air flow             |
| Amplifier protection | Thermal and DC protection<br>Stable into reactive or mismatched loads |
| Load protection      | On/off muting, DC-fault power supply shutdown                         |

### Power Supply, Voltage (Breaker/Fuse)

|                         |  |
|-------------------------|--|
| USA / Canada            | 120 V~, 60 Hz (T 6.3 A H 250 V)            |
| UK / Australia / Europe | 220-240 V~, 50/60 Hz<br>(T 3.15 A H 250 V) |
| Korea / China           | 220-240 V~, 50/60 Hz<br>(T 3.15 A H 250 V) |
| Japan                   | 100 V~, 50/60 Hz<br>(T 6.3 A H 250 V)      |
| Power consumption @ 2 Ω | 150 W                                      |
| Power consumption @ 4 Ω | 70 W                                       |
| Mains connector         | Standard IEC receptacle                    |

### Dimensions/Weight

|                        |   |
|------------------------|---|
| Dimensions (H x W x D) | appr. 3.5 x 19 x 9.76"<br>appr. 89 x 483 x 248 mm |
| Weight                 | 6.17 lbs / 2.8 kg                                 |

Please note these specifications are preliminary and conceptual in nature, and as such are subject to change as product development progresses. This information is supplied for market research purposes only and is not to be made public in any manner. This document is solely the property of The MUSIC Group, or one of its subsidiaries, and must be surrendered upon request of the owner.

For service, support or more information contact the BEHRINGER location nearest you:

**Europe**  
MUSIC Group Services UK  
Tel: +44 156 273 2290  
Email: CARE@music-group.com

**USA/Canada**  
MUSIC Group Services NV Inc.  
Tel: +1 702 800 8290  
Email: CARE@music-group.com

**Japan**  
MUSIC Group Services JP K.K.  
Tel: +81 3 6231 0454  
Email: CARE@music-group.com

Technical specifications and appearances are subject to change without notice and accuracy is not guaranteed. BEHRINGER, KLARK TEKNIK, MIDAS, BUGERA, and TURBOSOUND are part of the MUSIC Group (music-group.com). All trademarks are the property of their respective owners. MUSIC Group accepts no liability for any loss which may be suffered by any person who relies either wholly or in part upon any description, photograph or statement contained herein. Colors and specifications may vary from actual product. MUSIC Group products are sold through authorized fullfillers and resellers only. Fullfillers and resellers are not agents of MUSIC Group and have absolutely no authority to bind MUSIC Group by any express or implied undertaking or representation. This manual is copyrighted. No part of this manual may be reproduced or transmitted in any form or by any means, electronic or mechanical, including photocopying and recording of any kind, for any purpose, without the express written permission of MUSIC Group IP Ltd. ALL RIGHTS RESERVED.  
© 2013 MUSIC Group IP Ltd. Trident Chambers, Wickhams Cay, P.O. Box 146, Road Town, Tortola, British Virgin Islands. 985-10000-00486