

PA Amplifiers

iNUKE NU6000DSP NU3000DSP/NU1000DSP NU6000/NU3000/NU1000



iNUKE NU6000DSP—

**Ultra-Lightweight, High-Density
6000-Watt Power Amplifier with
DSP Control and USB Interface**

- Delivers 2 x 3000 Watts into 4 Ohms,
2 x 1500 Watts into 8 Ohms and
weighs less than 12 lbs / 5.5 kg

iNUKE NU3000DSP—

**Ultra-Lightweight, High-Density
3000-Watt Power Amplifier with
DSP Control and USB Interface**

- Delivers 2 x 1500 Watts into 2 Ohms;
2 x 880 Watts into 4 Ohms;
3000 Watts into 4 Ohms
(bridge mode) and weighs less
than 8 lbs / 3.5 kg

iNUKE NU1000DSP —

**Ultra-Lightweight, High-Density
1000-Watt Power Amplifier with DSP
Control and USB Interface**

- Delivers 2 x 500 Watts into 2 Ohms;
2 x 300 Watts into 4 Ohms;
1000 Watts into 4 Ohms
(bridge mode) and weighs less
than 8 lbs / 3.5 kg

Common features

- Ultimate reliability through revolutionary cool-running High-Density Class-D technology with “near-zero” thermal buildup
- Ultra-efficient switch-mode power supply for noise-free audio, superior transient response and low power consumption
- High-performance DSP and 24-bit/96 kHz converters deliver ultimate signal integrity and extreme dynamic range
- DSP section features sophisticated delay, crossover (3 filter types, up to 48 dB/octave), EQ (8 parametric, 2 dynamic), dynamics processing and lockable security settings

iNUKE Series power amplifiers pack massive amounts of output power into exceptionally lightweight, rack-mountable packages. Our revolutionary high-density Class-D technology combined with ultra-efficient switch-mode power supplies ensures these feather-light powerhouses will drive your rig effortlessly for many years to come.

Superb transient response

We spent years fine-tuning the high-density Class-D technology that gives the iNUKE Series its oomph. By carefully selecting transistors with extremely high slew rates and optimizing other proprietary parts of our circuitry, these amps react instantly to even the most demanding electronic bass impulses.

When this amazing amplifier technology is combined with our state-of-the-art switching-mode power supplies, these amplifiers provide tremendous punch. And because they are so much more efficient than conventional designs, they run cooler and don't require the massive heat sinks and heavy toroid transformers typically associated with their conventional counterparts.

Sublimely simple operation

The front panel controls and indicators provide your system's vital signs at a glance. After pressing the Power button, the Power LED lights to show the amp is ready for action. All channels feature positive-detent Gain controls with Signal LEDs that light when a signal is present, as well as clip LEDs to indicate when the signal is distorted and you need to reduce the input signal.

Continued on next page



iNUKE NU6000DSP NU3000DSP NU1000DSP NU6000 NU3000 NU1000

- Front panel LCD display enables setup and adjustment without PC
- Can be set up, controlled and monitored via front panel USB connector. Powerful remote software downloadable at behringer.com
- "Zero-Attack" limiters offer maximum output level with reliable overload protection
- Built-in Subwoofer/Satellite crossover for perfect subwoofer operation
- Detented and illuminated gain controls for precise level setting
- Precise 4-segment Signal and Limit LEDs to monitor performance
- XLR and 1/4" TRS combination input connectors for compatibility with any source
- Professional twist-lock speaker connectors for ultimate reliability
- Independent DC, LF and thermal overload protection on each channel automatically protects amplifier and speakers without shutting down the show
- "Back-to-front" ventilation system prevents thermal buildup for reliable operation
- High-quality components and exceptionally rugged construction ensure long life
- Conceived and designed by BEHRINGER Germany

The rear panel is just as elegant, with combo XLR and 1/4" TRS input connectors making the iNUKE compatible with virtually any source, balanced or unbalanced. Professional twist-lock speaker sockets are provided to ensure every drop of output power gets to your loudspeakers. The rear panel is also where you'll find the switches that enable iNUKE amps to work in either dual mono, stereo or mono bridge mode. A built-in CROSSOVER switch enables the amp to operate in biamp mode, sending low frequency content to passive subwoofers, while the high frequency output is channeled to fullrange loudspeakers (CH1 > 100 Hz / CH2 < 100 Hz or FULLRANGE).

iNUKE DSP

For sound engineers requiring high-level control capability, iNUKE DSP Series amplifiers come ready for action right out-of-the-box. The built-in DSP and 24-bit/96 kHz converters ensure the ultimate signal integrity with an extremely broad dynamic range. DSP functions include a sophisticated delay for delay-line loudspeakers, crossover, EQ (eight parametric, two dynamic), and dynamics processing with lockable security settings. A convenient front panel LCD display allows you to setup and make adjustments directly at the amplifier, without the need for a PC. All iNUKE DSP models can be set up, controlled and monitored via the front panel USB connector.

Continued on next page

iNUKE NU6000/NU3000/NU1000

Front Panel

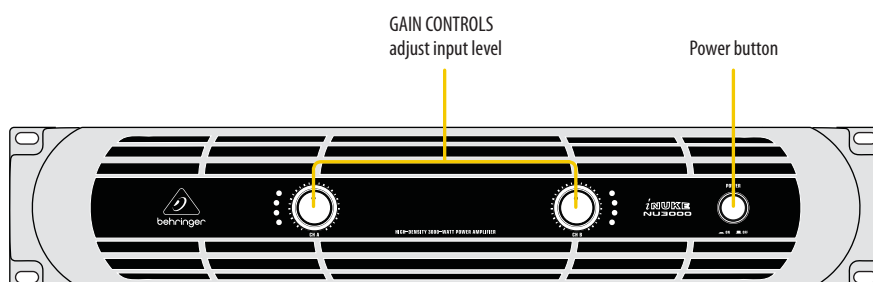

Rear Panel

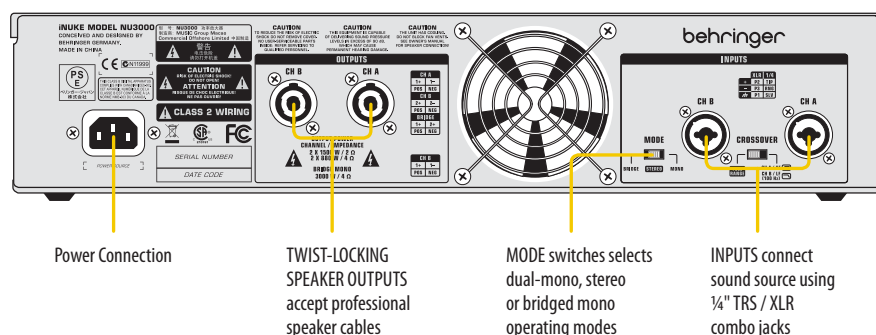

iNUKE NU6000DSP NU3000DSP NU1000DSP NU6000 NU3000 NU1000

iNUKE NU6000— Ultra-Lightweight, High-Density 6000-Watt Power Amplifier

- Delivers 2 x 3000 Watts into 4 Ohms, 2 x 1500 Watts into 8 Ohms and weighs less than 12 lbs / 5.5 kg

iNUKE NU3000— Ultra-Lightweight, High-Density 3000-Watt Power Amplifier

- Delivers 2 x 1500 Watts into 2 Ohms; 2 x 880 Watts into 4 Ohms; 3000 Watts into 4 Ohms (bridge mode) and weighs less than 7 lbs / 3.3 kg

iNUKE NU1000— Ultra-Lightweight, High-Density 1000-Watt Power Amplifier

- Delivers 2 x 500 Watts into 2 Ohms; 2 x 300 Watts into 4 Ohms; 1000 Watts into 4 Ohms (bridge mode) and weighs less than 7 lbs / 3.3 kg

Common features

- Ultimate reliability through revolutionary cool-running High-Density Class-D technology with “near-zero” thermal build up
- Ultra-efficient switch-mode power supply for noise-free audio, superior transient response and low power consumption
- “Zero-Attack” limiters offer maximum output level with reliable overload protection

behringer.com

Value

Sporting massive output ratings, lightweight Class-D technology, an equally lightweight price tag, and

all the amenities a professional audio engineer could ask for, BEHRINGER iNUKE amplifiers are serious amps for the most demanding applications.

iNUKE NU6000DSP/NU3000DSP/NU1000DSP

Front Panel

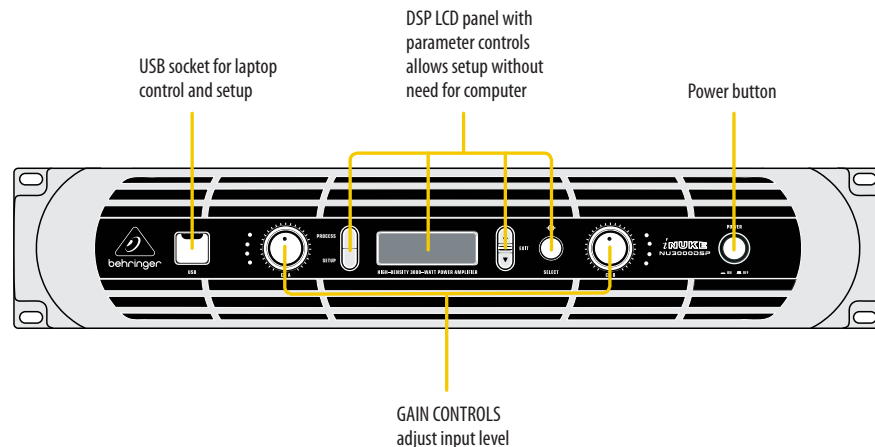

Rear Panel

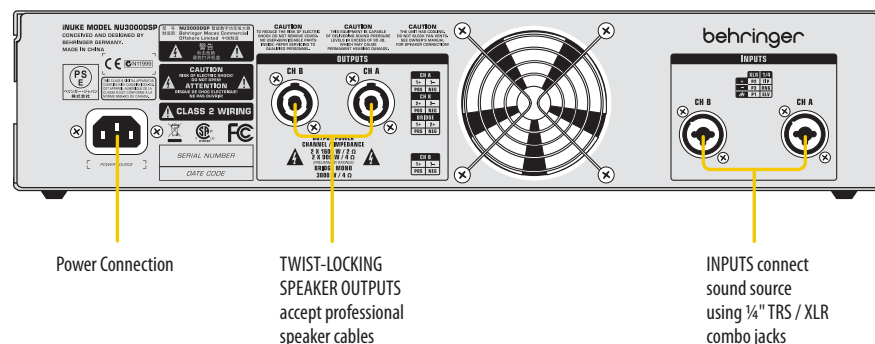

iNUKE NU6000DSP NU3000DSP NU1000DSP NU6000 NU3000 NU1000

- Built-in Subwoofer/Satellite crossover for perfect subwoofer operation
- Detented and illuminated gain controls for precise level setting
- Precise 4-segment Signal and Limit LEDs to monitor performance
- XLR and ¼" TRS combination input connectors for compatibility with any source
- Professional twist-lock speaker connectors for ultimate reliability
- Independent DC, LF and thermal overload protection on each channel automatically protects amplifier and speakers without shutting down the show
- "Back-to-front" ventilation system prevents thermal buildup for reliable operation
- High-quality components and exceptionally rugged construction ensure long life
- Conceived and designed by BEHRINGER Germany



System configuration is a breeze thanks to iNUKE's Amp Remote software (Available on iNUKE DSP models only)



Dynamic EQ combines the effects of equalization and side-chain compression to compensate for the perceived loudness of specific frequency ranges (Available on iNUKE DSP models only)



iNUKE's DSP crossover features 3 filter types (at up to 48 dB/octave) for the ultimate in versatility (Available on iNUKE DSP models only)



8 Parametric EQ filters make it easy to optimize system performance with just a few mouse clicks (Available on iNUKE DSP models only)



Save and recall frequently-used setups, complete with lockout codes for total system security (Available on iNUKE DSP models only)

**iNUKE NU6000DSP
NU3000DSP
NU1000DSP
NU6000
NU3000
NU1000**

iNUKE NU3000 – Live Setup with PA and Floor Monitor

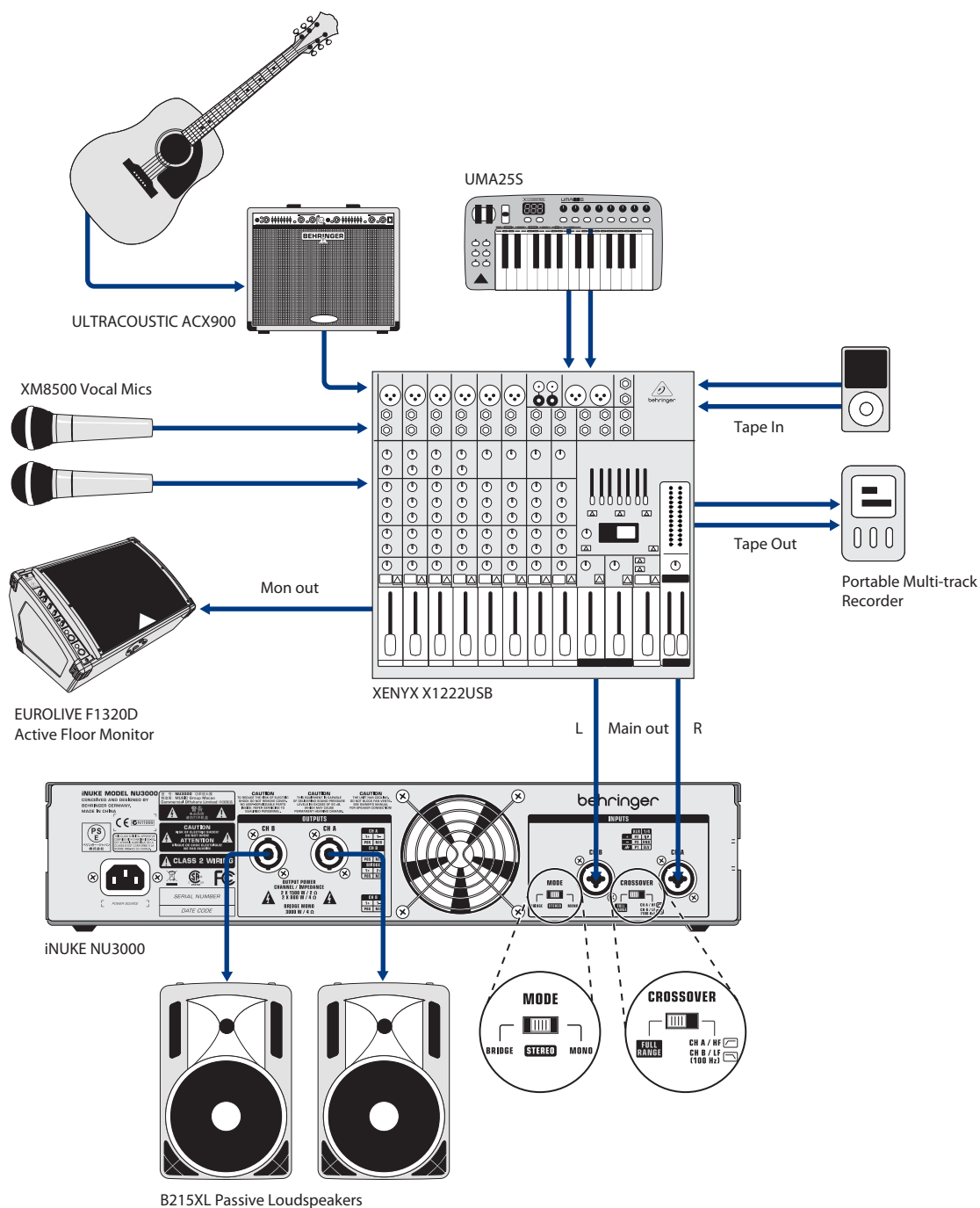

iNUKE NU6000DSP
NU3000DSP
NU1000DSP
NU6000
NU3000
NU1000

Concert Setup with Delay Line

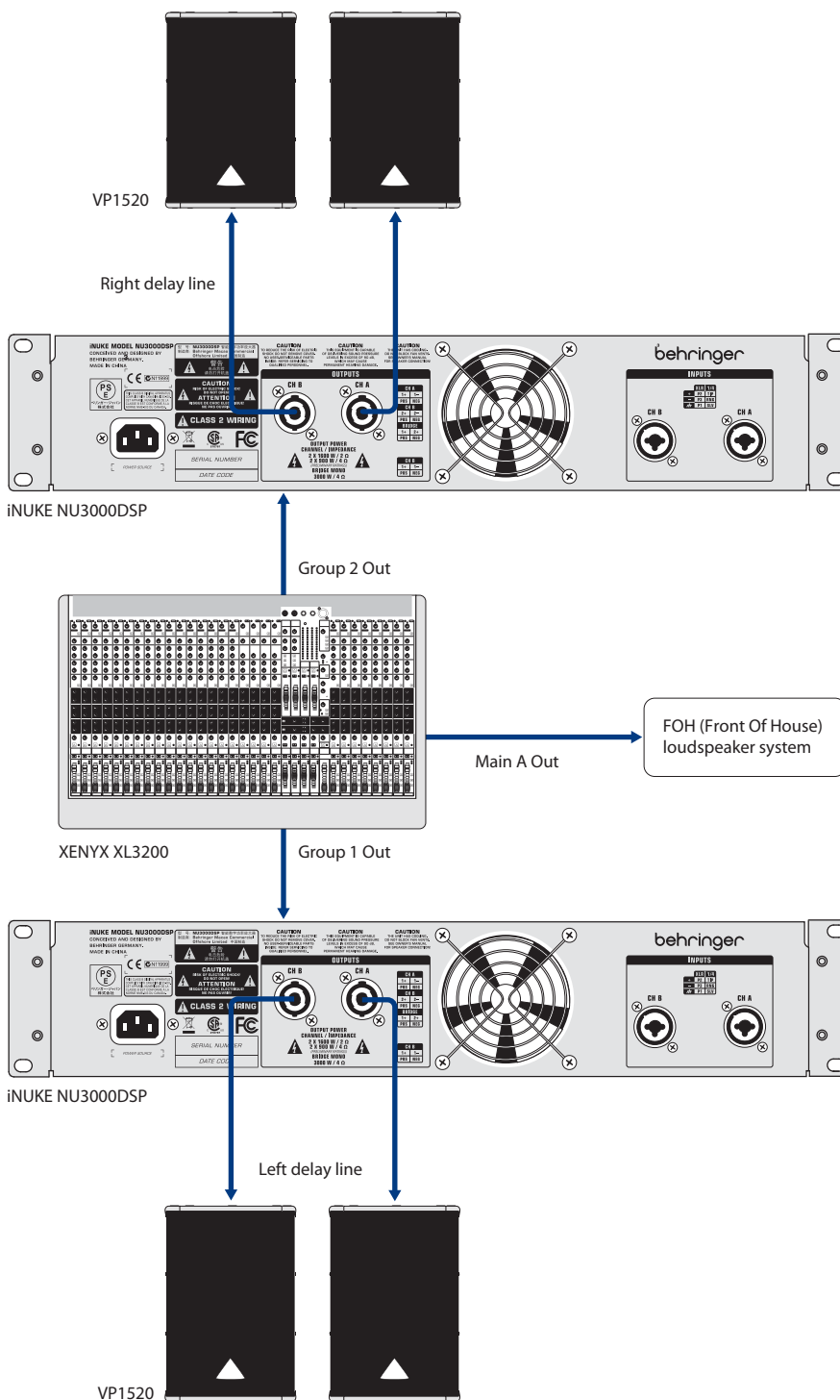

**iNUKE NU6000DSP
NU3000DSP
NU1000DSP
NU6000
NU3000
NU1000**

iNUKE NU1000 – Live Stereo DJ Setup with Passive PA

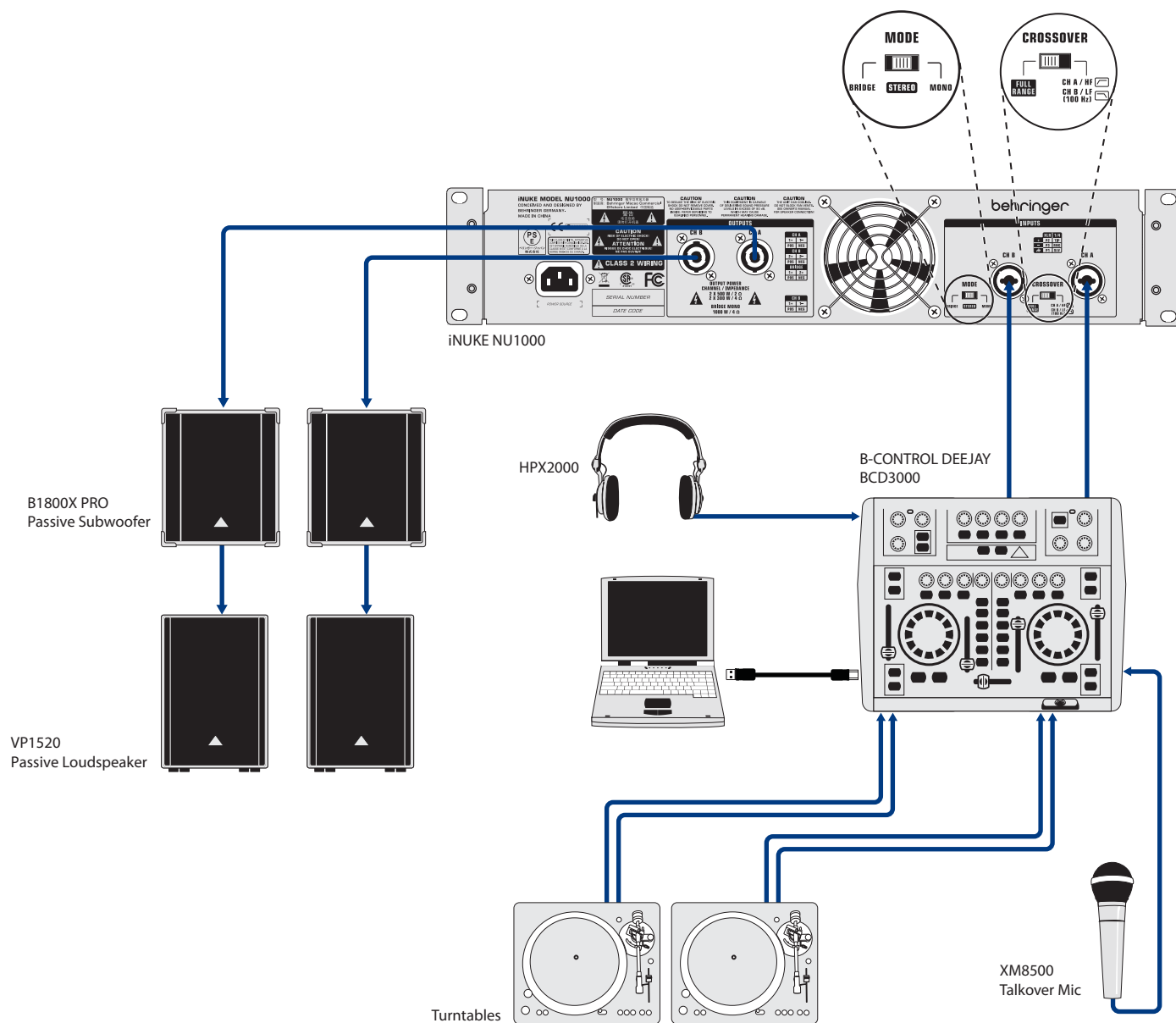

iNUKE NU6000DSP NU3000DSP NU1000DSP NU6000 NU3000 NU1000

Specifications

NU6000DSP

Output Power

Maximum output power

Stereo	
8 Ω per channel, stereo	1500 W
4 Ω per channel, stereo	3000 W
2 Ω per channel, stereo	—
Bridged mono	
8 Ω	—
4 Ω	—
RMS	
Stereo	
8 Ω per channel, stereo	1100 W
4 Ω per channel, stereo	2200 W
2 Ω per channel, stereo	—
Bridged mono	
8 Ω	—
4 Ω	—

System

Controls

Front	Power switch, Gain controls (channels A and B) DSP section rotary push-encoder, Buttons for Process, Setup, Up/Down, Exit
-------	---

Indicators

Power	Amber backlit illuminated gain controls
Limit (per channel)	0 dB, full scale
Signal (per channel)	-24, -12, -6 dB

Digital Signal Processing (DSP)

Display	LCD 128 x 32, amber backlit
Digital delay function (per channel)	0 - 300 ms
Digital crossover function	3 filter types, up to 48 dB/octave
Digital EQ function (per channel)	8-band parametric, 2-band dynamic equalizer
Digital dynamics function (per channel)	Zero attack limiter (peak)
Presets	20 total presets, 19 user-definable

Connectors

Inputs	2 x combo jacks
Input impedance	10 kΩ unbalanced, 20 kΩ balanced
Outputs	2 x locking-style professional speaker connectors
Output circuit type	Class D
Distortion	<0.2%
Frequency response	20 Hz to 20 kHz, +0 / -2 dB
Damping factor	>140 @ 8 Ω
Signal-to-noise	>98 dB
USB	Front panel USB connector type B for remote control of DSP section

Circuit Protection

Cooling	Continuously variable speed fan, Back-to-front air flow
Amplifier protection	Thermal and DC protection, Stable into reactive or mismatched loads
Load protection	On/off muting, DC-fault power supply shutdown

Power Supply, Power Consumption @ 1/8 Rated Power, Voltage (Breaker / Fuses)

USA / Canada	120V~, 60Hz (25A)
UK / Australia / Europe	220-240 V~, 50/60 Hz, (12A)
Korea / China	220-240 V~, 50/60 Hz, (12A)
Japan	100 V~, 50/60 Hz, (25A)
Power consumption @ 2 ohms	—
Power consumption @ 4 ohms	620 W
Mains connector	Standard IEC receptacle

Dimensions/Weight

Dimensions (H x W x D)	appr. 3.5 x 19.01 x 12.91" appr. 89 x 483 x 328 mm
Weight	appr. 11.4 lbs / 5.2 kg

NU3000DSP

Output Power

Maximum output power

Stereo	
8 Ω per channel, stereo	440 W
4 Ω per channel, stereo	820 W
2 Ω per channel, stereo	1520 W
Bridged mono	
8 Ω	1500 W
4 Ω	3000 W
RMS	
Stereo	
8 Ω per channel, stereo	315 W
4 Ω per channel, stereo	620 W
2 Ω per channel, stereo	1040 W
Bridged mono	
8 Ω	1250 W
4 Ω	2075 W

System

Controls

Front	Power switch, Gain controls (channels A and B) DSP section rotary push-encoder, Buttons for Process, Setup, Up/Down, Exit
-------	---

Indicators

Power	Amber backlit illuminated gain controls
Limit (per channel)	0 dB, full scale
Signal (per channel)	-24, -12, -6 dB

Digital Signal Processing (DSP)

Display	LCD 128 x 32, amber backlit
Digital delay function (per channel)	0 - 300 ms
Digital crossover function	3 filter types, up to 48 dB/octave
Digital EQ function (per channel)	8-band parametric, 2-band dynamic equalizer
Digital dynamics function (per channel)	Zero attack limiter (peak)
Presets	20 total presets, 19 user-definable

iNUKE NU6000DSP NU3000DSP NU1000DSP NU6000 NU3000 NU1000

Connectors

Inputs	2 x combo jacks
Input impedance	10 k Ω unbalanced, 20 k Ω balanced
Outputs	2 x locking-style professional speaker connectors
Output circuit type	Class D
Distortion	<0.3%
Frequency response	20 Hz to 20 kHz, +0 / -1 dB
Damping factor	>145 @ 8 Ω
Signal-to-noise	>98 dB
USB	Front panel USB connector type B for remote control of DSP section

Circuit Protection

Cooling	Continuously variable speed fan, Back-to-front air flow
Amplifier protection	Thermal and DC protection, Stable into reactive or mismatched loads
Load protection	On/off muting, DC-fault power supply shutdown

Power Supply, Power Consumption @ 1/8 Rated Power, Voltage (Breaker / Fuses)

USA / Canada	120 V~, 60 Hz (T 10 A H 250 V)
UK / Australia / Europe	220-240 V~, 50/60 Hz (T 6.3 A H 250 V)
Korea / China	220-240 V~, 50/60 Hz (T 6.3 A H 250 V)
Japan	100 V~, 50/60 Hz (T 10 A H 250 V)
Power consumption @ 2 ohms	350 W
Power consumption @ 4 ohms	210 W
Mains connector	Standard IEC receptacle

Dimensions/Weight

Dimensions (H x W x D)	appr. 3.5 x 19 x 9.76" appr. 89 x 483 x 248 mm
Weight	appr. 6.8 lbs / 3.1 kg

NU1000DSP

Output Power

Maximum Output Power

Stereo	
8 Ω per channel, stereo	160 W
4 Ω per channel, stereo	320 W
2 Ω per channel, stereo	530 W
Bridged mono	
8 Ω	570 W
4 Ω	1050 W
RMS	
Stereo	
8 Ω per channel, stereo	110 W
4 Ω per channel, stereo	210 W
2 Ω per channel, stereo	380 W
Bridged mono	
8 Ω	430 W
4 Ω	750 W

System

Controls

Front	Front Power switch, Gain controls (channels A and B) DSP section rotary push-encoder, Buttons for Process, Setup, Up/Down, Exit
-------	--

Indicators

Power	Amber backlit illuminated gain controls
Limit (per channel)	0 dB, full scale
Signal (per channel)	-24, -12, -6 dB

Digital Signal Processing (DSP)

Display	LCD 128 x 32, amber backlit
Digital delay function (per channel)	0 - 300 ms
Digital crossover function	3 filter types, up to 48 dB/octave
Digital EQ function (per channel)	8-band parametric, 2-band dynamic equalizer
Digital dynamics function (per channel)	Zero attack limiter (peak)
Presets	20 total presets, 19 user-definable

Connectors

Inputs	2 x combo jacks
Input impedance	10 k Ω unbalanced, 20 k Ω balanced
Outputs	2 x locking-style professional speaker connectors
Output circuit type	Class D
Distortion	<0.1%
Frequency response	20 Hz to 20 kHz, +0 / -1 dB
Damping factor	>155 @ 8 Ω
Signal-to-noise	>98 dB
USB	Front panel USB connector type B for remote control of DSP section

Circuit Protection

Cooling	Continuously variable speed fan, Back-to-front air flow
Amplifier protection	Thermal and DC protection, Stable into reactive or mismatched loads
Load protection	On/off muting, DC-fault power supply shutdown

Power Supply, Power Consumption @ 1/8 Rated Power, Voltage (Breaker / Fuses)

USA / Canada	120 V~, 60 Hz (T 6.3 A H 250 V)
UK / Australia / Europe	220-240 V~, 50/60 Hz (T 3.15 A H 250 V)
Korea / China	220-240 V~, 50/60 Hz (T 3.15 A H 250 V)
Japan	100 V~, 50/60 Hz (T 6.3 A H 250 V)
Power consumption @ 2 ohms	150 W
Power consumption @ 4 ohms	70 W
Mains connector	Standard IEC receptacle

Dimensions/Weight

Dimensions (H x W x D)	appr. 3.5 x 19 x 9.76" appr. 89 x 483 x 248 mm
Weight	appr. 6.8 lbs / 3.1 kg

iNUKE NU6000DSP NU3000DSP NU1000DSP NU6000 NU3000 NU1000

NU6000

Output Power

Maximum Output Power

Stereo	
8 Ω per channel, stereo	1500 W
4 Ω per channel, stereo	3000 W
2 Ω per channel, stereo	—
Bridged mono	
8 Ω	—
4 Ω	—
RMS	
Stereo	
8 Ω per channel, stereo	1100 W
4 Ω per channel, stereo	2200 W
2 Ω per channel, stereo	—
Bridged mono	
8 Ω	—
4 Ω	—

System

Controls

Front	Power switch Gain controls (channels A and B)
Rear	Mode switch (stereo/mono) Crossover switch (fullrange/100 Hz)

Indicators

Power	Amber/red backlit illuminated gain controls
Limit (per channel)	0 dB, full scale
Signal (per channel)	-24, -12, -6 dB

Connectors

Inputs	2 x combo jacks
Input impedance	10 k Ω unbalanced, 20 k Ω balanced
Outputs	2 x locking-style professional speaker connectors
Output circuit type	Class D
Distortion	<0.2%
Frequency response	20 Hz to 20 kHz, +0 / -2 dB
Damping factor	>140 @ 8 Ω
Signal-to-noise	>100 dB

Circuit Protection

Cooling	Continuously variable speed fan Back-to-front air flow
---------	---

Amplifier protection	Thermal and DC protection Stable into reactive or mismatched loads
Load protection	On/off muting, DC-fault power supply shutdown

Power Supply, Voltage (Breaker/Fuse)

USA / Canada	120V~, 60Hz (25A)
UK / Australia / Europe	220-240 V~, 50/60 Hz, (12A)
Korea / China	220-240 V~, 50/60 Hz, (12A)
Japan	100 V~, 50/60 Hz, (25A)
Power consumption @ 2 Ω	—
Power consumption @ 4 Ω	620 W
Mains connector	Standard IEC receptacle

Dimensions/Weight

Dimensions (H x W x D)	appr. 3.5 x 19 x 12.91" appr. 89 x 483 x 328 mm
Weight	11 lbs / 5 kg

NU3000

Output Power

Maximum Output Power

Stereo	
8 Ω per channel, stereo	440 W
4 Ω per channel, stereo	880 W
2 Ω per channel, stereo	1500 W
Bridged mono	
8 Ω	1500 W
4 Ω	3000 W
RMS	
Stereo	
8 Ω per channel, stereo	280 W
4 Ω per channel, stereo	550 W
2 Ω per channel, stereo	1100 W
Bridged mono	
8 Ω	1100 W
4 Ω	2200 W

System

Controls

Front	Power switch Gain controls (channels A and B)
Rear	Mode switch (bridge/stereo/mono) Crossover switch (fullrange/100 Hz)

Indicators

Power	Amber/red backlit illuminated gain controls
Limit (per channel)	0 dB, full scale
Signal (per channel)	-24, -12, -6 dB

Connectors

Inputs	2 x combo jacks
Input impedance	10 k Ω unbalanced, 20 k Ω balanced
Outputs	2 x locking-style professional speaker connectors
Output circuit type	Class D
Distortion	<0.2%
Frequency response	20 Hz to 20 kHz, +0 / -1 dB
Damping factor	>160 @ 8 Ω
Signal-to-noise	>100 dB

Circuit Protection

Cooling	Continuously variable speed fan Back-to-front air flow
Amplifier protection	Thermal and DC protection Stable into reactive or mismatched loads
Load protection	On/off muting, DC-fault power supply shutdown

Power Supply, Voltage (Breaker/Fuse)

USA / Canada	120 V~, 60 Hz (T 10 A H 250 V)
UK / Australia / Europe	220-240 V~, 50/60 Hz (T 6.3 A H 250 V)
Korea / China	220-240 V~, 50/60 Hz (T 6.3 A H 250 V)
Japan	100 V~, 50/60 Hz (T 10 A H 250 V)
Power consumption @ 2 Ω	350 W
Power consumption @ 4 Ω	170 W
Mains connector	Standard IEC receptacle

Dimensions/Weight

Dimensions (H x W x D)	appr. 3.5 x 19 x 9.76" appr. 89 x 483 x 248 mm
Weight	6.17 lbs / 2.8 kg

iNUKE NU6000DSP NU3000DSP NU1000DSP NU6000 NU3000 NU1000

NU1000

Output Power

Maximum Output Power

Stereo

8 Ω per channel, stereo	150 W
4 Ω per channel, stereo	300 W
2 Ω per channel, stereo	500 W

Bridged mono

8 Ω	500 W
4 Ω	1000 W

RMS

Stereo

8 Ω per channel, stereo	100 W
4 Ω per channel, stereo	200 W
2 Ω per channel, stereo	400 W

Bridged mono

8 Ω	400 W
4 Ω	800 W

System

Controls

Front	Power switch Gain controls (channels A and B)
Rear	Mode switch (bridge/stereo/mono) Crossover switch (fullrange/100 Hz)

Indicators

Power	Amber/red backlit illuminated gain controls
Limit (per channel)	0 dB, full scale
Signal (per channel)	-24, -12, -6 dB

Connectors

Inputs	2 x combo jacks
Input impedance	10 k Ω unbalanced, 20 k Ω balanced
Outputs	2 x locking-style professional speaker connectors
Output circuit type	Class D
Distortion	<0.1%
Frequency response	20 Hz to 20 kHz, +0 / -1 dB
Damping factor	>155 @ 8 Ω
Signal-to-noise	>100 dB

Circuit Protection

Cooling	Continuously variable speed fan Back-to-front air flow
Amplifier protection	Thermal and DC protection Stable into reactive or mismatched loads
Load protection	On/off muting, DC-fault power supply shutdown

Power Supply, Voltage (Breaker/Fuse)

USA / Canada	120 V~, 60 Hz (T 6.3 A H 250 V)
UK / Australia / Europe	220-240 V~, 50/60 Hz (T 3.15 A H 250 V)
Korea / China	220-240 V~, 50/60 Hz (T 3.15 A H 250 V)
Japan	100 V~, 50/60 Hz (T 6.3 A H 250 V)
Power consumption @ 2 Ω	150 W
Power consumption @ 4 Ω	70 W
Mains connector	Standard IEC receptacle

Dimensions/Weight

Dimensions (H x W x D)	appr. 3.5 x 19 x 9.76" appr. 89 x 483 x 248 mm
Weight	6.17 lbs / 2.8 kg

Please note these specifications are preliminary and conceptual in nature, and as such are subject to change as product development progresses. This information is supplied for market research purposes only and is not to be made public in any manner. This document is solely the property of The MUSIC Group, or one of its subsidiaries, and must be surrendered upon request of the owner.

For service, support or more information contact the BEHRINGER location nearest you:

Europe MUSIC Group Services EU GmbH
Tel.: +49 2154 9206 4149 / Fax: +49 2154 9206 4199

USA/Canada MUSIC Group Services US Inc.
Tel.: +1 425 672 0816 / Fax: +1 425 673 7647

Singapore MUSIC Group Services SG (Pte.) Ltd
Tel.: +65 6845 1800 / Fax: +65 6214 0275

Australia MUSIC Group Services AU Pty Ltd
Tel.: +61 03 9877 7170 / Fax: +61 03 9877 7870

Japan MUSIC Group Services JP K.K.
Tel.: +81 3 5281 1180 / Fax: +81 3 5281 1181

TECHNICAL SPECIFICATIONS AND APPEARANCES ARE SUBJECT TO CHANGE WITHOUT NOTICE AND ACCURACY IS NOT GUARANTEED. BEHRINGER IS PART OF THE MUSIC GROUP (MUSIC-GROUP.COM). ALL TRADEMARKS ARE THE PROPERTY OF THEIR RESPECTIVE OWNERS. MUSIC GROUP ACCEPTS NO LIABILITY FOR ANY LOSS WHICH MAY BE SUFFERED BY ANY PERSON WHO RELIES EITHER WHOLLY OR IN PART UPON ANY DESCRIPTION, PHOTOGRAPH OR STATEMENT CONTAINED HEREIN. COLORS AND SPECIFICATIONS MAY VARY FROM ACTUAL PRODUCT. MUSIC GROUP PRODUCTS ARE SOLD THROUGH AUTHORIZED FULFILLERS AND RESELLERS ONLY. ALL RIGHTS RESERVED. © 2011 MUSIC Group IP Ltd, Trident Chambers, Wickhams Cay, P.O. Box 146, Road Town, Tortola, British Virgin Islands. 985-10000-00486